

Алматы (727)345-47-04
Ангарск (3955)60-70-56
Архангельск (8182)63-90-72
Астрахань (8512)99-46-04
Барнаул (3852)73-04-60
Белгород (4722)40-23-64
Благовещенск (4162)22-76-07
Брянск (4832)59-03-52
Владивосток (423)249-28-31
Владикавказ (8672)28-90-48
Владимир (4922)49-43-18
Волгоград (844)278-03-48
Вологда (8172)26-41-59
Воронеж (473)204-51-73
Екатеринбург (343)384-55-89

Россия +7(495)268-04-70

Иваново (4932)77-34-06
Ижевск (3412)26-03-58
Иркутск (395)279-98-46
Казань (843)206-01-48
Калининград (4012)72-03-81
Калуга (4842)92-23-67
Кемерово (3842)65-04-62
Киров (8332)68-02-04
Коломна (4966)23-41-49
Кострома (4942)77-07-48
Краснодар (861)203-40-90
Красноярск (391)204-63-61
Курск (4712)77-13-04
Курган (3522)50-90-47
Липецк (4742)52-20-81

Казахстан +7(727)345-47-04

Магнитогорск (3519)55-03-13
Москва (495)268-04-70
Мурманск (8152)59-64-93
Набережные Челны (8552)20-53-41
Нижний Новгород (831)429-08-12
Новокузнецк (3843)20-46-81
Ноябрьск (3496)41-32-12
Новосибирск (383)227-86-73
Омск (3812)21-46-40
Орел (4862)44-53-42
Оренбург (3532)37-68-04
Пенза (8412)22-31-16
Петрозаводск (8142)55-98-37
Псков (8112)59-10-37
Пермь (342)205-81-47

Беларусь +(375)257-127-884

Ростов-на-Дону (863)308-18-15
Рязань (4912)46-61-64
Самара (846)206-03-16
Санкт-Петербург (812)309-46-40
Саранск (8342)22-96-24
Саратов (845)249-38-78
Севастополь (8692)22-31-93
Симферополь (3652)67-13-56
Смоленск (4812)29-41-54
Сочи (862)225-72-31
Ставрополь (8652)20-65-13
Сургут (3462)77-98-35
Сыктывкар (8212)25-95-17
Тамбов (4752)50-40-97
Тверь (4822)63-31-35

Узбекистан +998(71)205-18-59

Тольятти (8482)63-91-07
Томск (3822)98-41-53
Тула (4872)33-79-87
Тюмень (3452)66-21-18
Улан-Удэ (3012)59-97-51
Ульяновск (8422)24-23-59
Уфа (347)229-48-12
Хабаровск (4212)92-98-04
Чебоксары (8352)28-53-07
Челябинск (351)202-03-61
Череповец (8202)49-02-64
Чита (3022)38-34-83
Якутск (4112)23-90-97
Ярославль (4852)69-52-93

Киргизия +996(312)96-26-47

<https://alegacy.nt-rt.ru> || ayf@nt-rt.ru

КАТАЛОГ



CUSTOM
SOLUTIONS



COLOR
CODED



MADE IN
THE U.S.A.

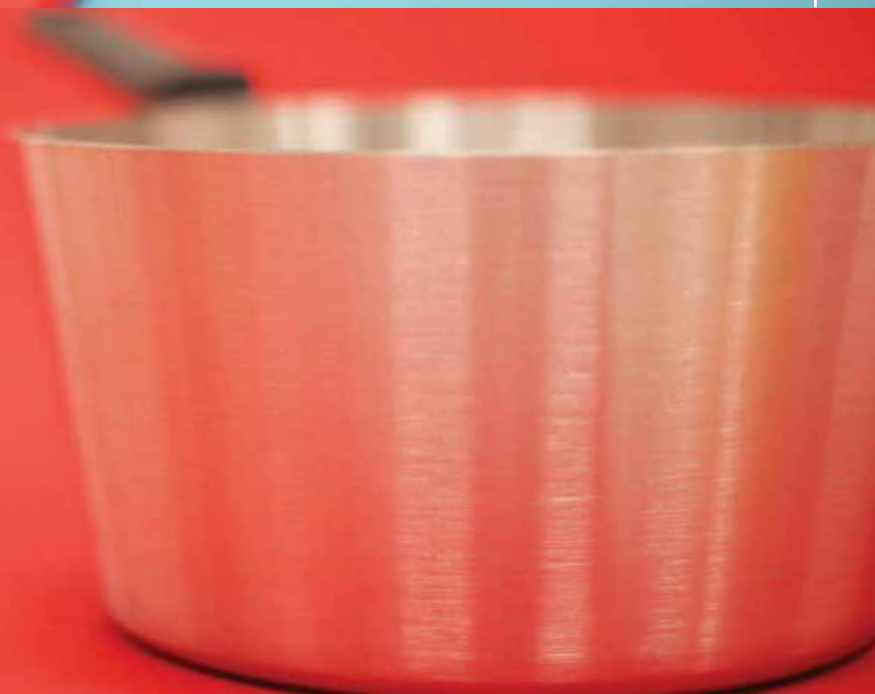

SMALL DETAILS, BIG INNOVATIONS

Focusing on the number of rivets and specialized alloy in an Eagleware® fry pan; obsessing over a beadless pan rim to eliminate food traps; developing a line of buffetware that has to pass weight and balance tests to ensure ease of service. Creating color-coded hand tools and cutting boards to protect food safety. It's this attention to detail that makes Alegacy a first-choice brand with some of the best-known chefs in the most successful commercial kitchens.

For over 70 years, Alegacy has been providing the ultimate in quality smallwares by listening to our customers and creating custom solutions that improve efficiency and the bottom line. Our manufacturing and quality control are based in Southern California, which gives us the ability to quickly adapt to market needs and ensure Alegacy smallwares deliver exceptional performance and lasting value.

Tastes change. Menus change. Kitchens change. But, the Alegacy dedication to fresh thinking, quality and product innovation endures. We know there's already enough heat in the kitchen, so we sweat the details.





Since 1947, Alegacy has been providing the ultimate in quality professional cookware at extremely competitive pricing. And we've done so while maintaining our core principle, "customer satisfaction is the most important thing we offer."

Whether on our Eagleware® cookware line, proudly made in the U.S.A. at our manufacturing facility, or the extensive array of top-end products we find around the world – everything we offer, across all performance tiers, is constructed to the Alegacy standard of quality and value.

Less evident on the pages of this catalog, but equally important, is how we listen and respond to our customers. From developing products to serve specific needs in busy commercial kitchens to enhancing our offerings based on your input, our goal is to support you in every possible way.

This catalog is a starting point to a long-lasting relationship. We invite you to see how we can solve your kitchen needs. And feel free to reach out to us with any questions or feedback. Remember, this is meant to serve you, just like we have been serving chefs for over seven decades.

TABLE OF CONTENTS

-  Professional Cookware
4 - 29
-  Bakeware & Supplies
30 - 47
-  Bar Supplies
48 - 59
-  Plasticware
60 - 73
-  Chafers & Buffetware
74 - 97
-  Steam Table Pans & Insets
98 - 107
-  Kitchen Utensils
108 - 145
-  Food Preparation
146 - 177
-  Pizza Supplies
178 - 185
-  Tabletop & Service
186 - 225
-  Janitorial & Brushes
226 - 231

 TM Alegacy continues to expand its extensive imported economy line. These offerings are easily identified by the Alegacy economy line icon and matching green color code.

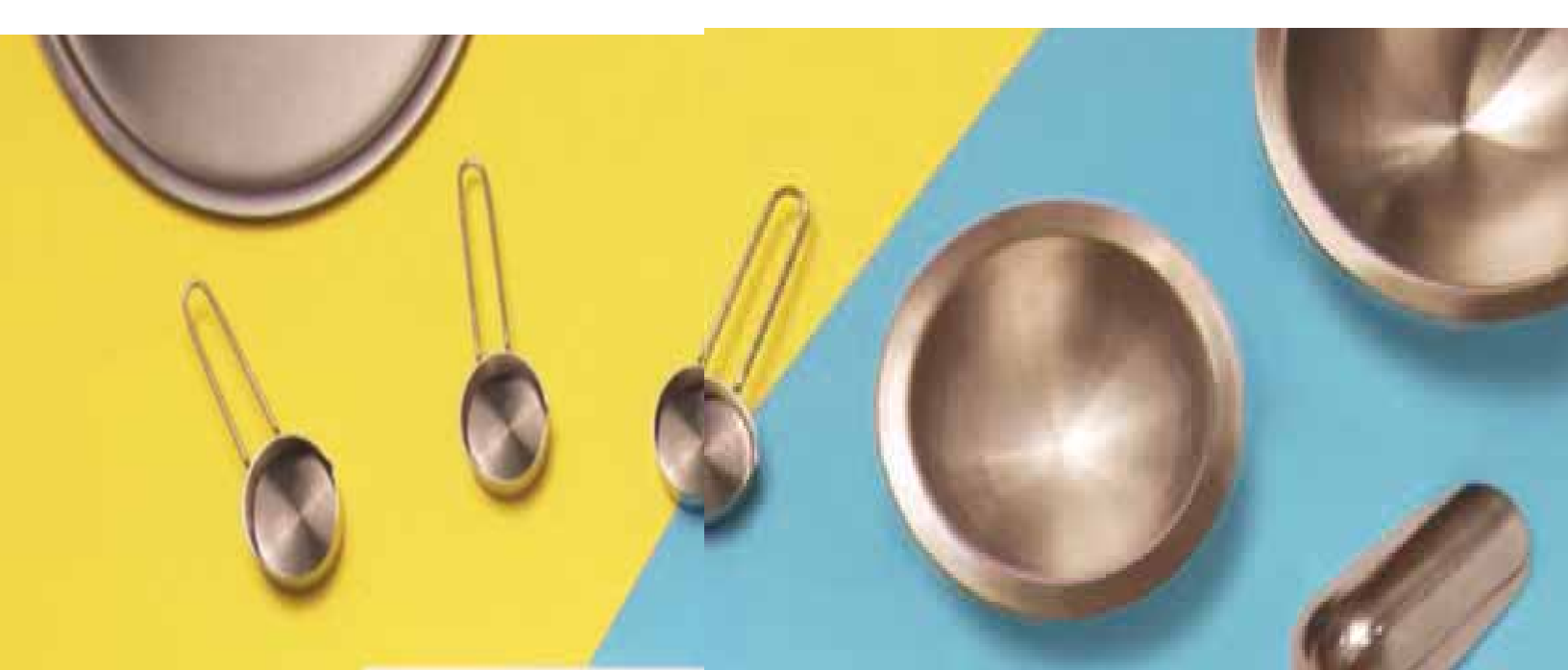

PROFESSIONAL COOKWARE

Eagleware®

Made in the U.S.A.

Stock Pots & Sauce Pots
6 - 7

Fry Pans & Sauce Pans
8 - 11

Braziers
12

Double Boilers
13

Sauté Pans
13

Heavy-Duty Cookware
14 - 15

Bun Pans
16

Pizza Pans
17

Imported Cookware

Optima® Aluminum Cookware
18-21

Optima® Stainless Steel
Cookware
22 - 25

Wire/Perf. Baskets
26

Steel Fry Pans
27

Steel Fry Bottoms & Basket
28

Roast Pans
29



Stock Pots & Sauce Pots

Unequaled versatility and durability makes Eagleware® the top choice in commercial kitchens worldwide. The thermally efficient 3004 alloy evenly distributes heat from the source to the rim. The high quality of this prime aluminum alloy, compared to softer 3003 or 1100 alloy material, means greater dent-resistance and durability. And that spells overall savings for you in the long run. The securely riveted handles are nickel/chrome-plated steel, and will be replaced less often than softer aluminum welded/riveted handles. Finally, the uniform satin finish pot with straight sidewalls not only optimizes heat distribution but also eliminates the transfer of food flavors and makes for easy cleanup.



STOCK POTS

Eagleware offers a wide range of stock pots for nearly every cooking application. The 3004 aluminum alloy provides extra dent-resistance to enhance durability and promote maximum thermal efficiency. Thermal conductivity is further boosted by the pots' lustrous satin finish interiors and exteriors. All Eagleware stock pots have extra heavy-duty plated handles and beadless rims which do not trap food particles, making for easy cleanup. All pots are available with .080" (2 mm) thick aluminum covers with formed handles.

ITEM	WITH COVER	CAPACITY		INSIDE DIAMETER		INSIDE DEPTH		GAUGE	PACK	COVER TO FIT
		QT	L	IN	CM	IN	CM			
EW10	EW10WC	10	9.5	10	25.4	7 5/8	19.4	8	1	EWC10
EW12	EW12WC	12	11.4	10	25.4	9	22.9	8	1	EWC10
EW16	EW16WC	16	15.1	10	25.4	12	30.5	8	1	EWC10
EW20	EW20WC	20	18.9	12	30.5	10 5/8	27	8	1	EWC20
EW24	EW24WC	24	22.7	12	30.5	12 7/16	31.6	8	1	EWC20
EW32	EW32WC	32	30.3	14	35.6	11 5/8	29.5	8	1	EWC40
EW40	EW40WC	40	37.9	14	35.6	15	38.1	8	1	EWC40
EW60	EW60WC	60	56.8	16	40.6	17 1/2	44.5	6	1	EWC60
EW80	EW80WC	80	75.7	19	48.3	16 1/4	41.3	6	1	EWC80



SAUCE POTS

Thermal conductivity is paramount when simmering sauces for long periods of time. Eagleware sauce pots’ satin finish interior and exterior and 3004 aluminum alloy ensure even and thorough heat transfer for exactly this purpose. Extra heavy-duty plated handles and beadless rims make using Eagleware sauce pots safe and easy. All pots are available with .080” (2 mm) thick aluminum covers with formed handles.

ITEM	WITH COVER	CAPACITY		INSIDE DIAMETER		INSIDE DEPTH		GAUGE	PACK	COVER TO FIT
		QT	L	IN	CM	IN	CM			
EW06	EW06WC	6	5.7	10	25.4	4 1/2	11.4	8	1	EWC10
EW0812	EW0812WC	8 1/2	8	10	25.4	6 3/8	16.2	8	1	EWC10
EW010	EW010WC	10	9.5	12	30.5	5 1/4	13.3	8	1	EWC20
EW14	EW14WC	14	13.2	12	30.5	7 1/2	19	8	1	EWC20

STOCK POTS WITH FAUCETS

Stock pots with faucets make transfers almost effortless and can be removed and disassembled for quick cleaning. Faucets are made entirely of highly polished, stainless steel, with no plastic parts, for continuous or manually controlled draining. They can be bought separately or as a replacement item.



ITEM	WITH COVER	CAPACITY		INSIDE DIAMETER		INSIDE DEPTH		GAUGE	PACK	COVER TO FIT
		QT	L	IN	CM	IN	CM			
EW40F	EW40FWC	40	37.9	14	35.6	15	38.1	8	1	EWC40
EW60F	EW60FWC	60	56.8	16	40.6	17 1/2	44.5	6	1	EWC60
EW80F	EW80FWC	80	75.7	19	48.3	6 1/4	41.3	6	1	EWC80

Professional Aluminum Fry Pans

Eagleware® fry pans come in a variety of finishes and are equipped with high quality non-stick surfaces and EagleGrip™ silicone grips. Their special alloy rivets secure the handle and are designed to resist tough commercial kitchen use, while their superior 3004 dent-resistant aluminum makes them a step above pans made of softer alloys. Available in three finishes: Natural, Teflon® Xtra, and Teflon® Platinum Pro.



TEFLON® XTRA FRY PANS

The pewter-colored Teflon Xtra finish provides the most economical method of non-stick cooking by combining good release characteristics and easy cleanup. Made of 3004 aluminum alloy for dent-resistance and efficient heat transfer, they come with a full satin finished exterior. The stamped steel handle is held securely with three special alloy rivets and has an eye for hanging. All pans come with the EagleGrip insulating grip to provide comfortable and efficient long-lasting performance.

ITEM	TOP		BOTTOM		INSIDE DEPTH		GAUGE	PACK
	IN	CM	IN	CM	IN	CM		
SEW1018	7	18	4 3/4	12.1	1 3/8	3.5	10	12
SEW1020	8	20	5 3/4	14.7	1 3/4	4.4	10	12
SEW1025	10	25	7 5/8	19.4	2	5.1	8	12
SEW1030	12	30	9 3/4	24.8	2 1/4	5.7	7	6
SEW1035	14	35	11	28	2 7/16	6.2	7	6

* Teflon® Xtra and Teflon® Platinum Pro are Chemours registered trademarks for their non-stick surfaces.



TEFLON® PLATINUM PRO FRY PANS

Fast-paced kitchens rely on our Teflon Platinum Pro to deliver results. These high-end, ceramic reinforced non-stick pans provide even temperatures for consistent performance. The stamped steel handle is solidly fastened with three special alloy rivets to hold up against the toughest cooking environment. All pans feature the EagleGrip insulating grip to provide comfortable and efficient long-lasting performance.



ITEM	TOP		BOTTOM		INSIDE DEPTH		GAUGE	PACK
	IN	CM	IN	CM	IN	CM		
SEW5018	7	18	4 3/4	12.1	1 3/8	3.5	10	12
SEW5020	8	20	5 3/4	14.7	1 3/4	4.4	10	12
SEW5025	10	25	7 5/8	19.4	2	5.1	8	12
SEW5030	12	30	9 3/4	24.8	2 1/4	5.7	7	6
SEW5035	14	35	11	28	2 7/16	6.2	7	6

NATURAL ALUMINUM FRY PANS

For durability and value, look to these heavy gauge aluminum fry pans. They are made of dent-resistant 3004 aluminum for efficient heat transfer, and have a full satin finished interior and exterior. The stamped steel handle is held securely with three special alloy rivets and has an eye for hanging. All pans come with the EagleGrip insulating grip to provide comfortable and efficient long-lasting performance.



ITEM	TOP		BOTTOM		INSIDE DEPTH		GAUGE	PACK
	IN	CM	IN	CM	IN	CM		
EW1018	7	18	4 3/4	12.1	1 3/8	3.5	10	12
EW1020	8	20	5 3/4	14.7	1 3/4	4.4	10	12
EW1025	10	25	7 5/8	19.4	2	5.1	8	12
EW1030	12	30	9 3/4	24.8	2 1/4	5.7	7	6
EW1035	14	35	11	28	2 7/16	6.2	7	6



EAGLEGRIP™ INSULATING GRIPS

The state-of-the-art EagleGrip insulating grip puts cooking comfort, safety, and efficiency in the palm of your hand. The ergonomic design (with thumb stop and under edge ribbing) prevents slippage and promotes safety. Their silicone rubber composition minimizes heat transfer and can withstand temperatures up to approximately 500°F (260°C). When exposed to direct flame they char to white and can be easily wiped away. They are simple to install on existing pans, and are removable for easy soap and water cleanup. EagleGrip insulating grips are sold separately for easy replacement or to complement existing cookware.

ITEM	FITS PAN #	IN	CM	PACK
SEG18	EW1018, SEW1018, SEW5018, EW1020, SEW1020, SEW5020, EWA1, EWA2	4 9/16	11.6	12
SEG25	EW1025, SEW1025, SEW5025, EW1030, SEW1030, SEW5030	5 3/8	13.7	12
SEG35	EW1035, SEW1035, SEW5035, EWA3, EWA4, EWA5, EWA7, EWA8, EWA10, EWP3, EWP5, EWP7	5 7/8	14.9	12

PROFESSIONAL ALUMINUM SAUCE PANS

Our well-balanced, natural finish aluminium sauce pans are tailored to meet the needs of every chef. Their combination of tapered sides, rounded corners, flat bottoms, and a highly polished finish foster practicality and ease of use. The large, stamped steel handles are securely attached with three heavy aluminum rivets, plus an eye for hanging and include an EagleGrip insulating grip. They are constructed of .080" (2 mm) and .100" (2 mm) hard sheet aluminum and available in eight nesting sizes.



ITEM	COVERS TO FIT	CAPACITY		TOP		BOTTOM		HEIGHT		PAN GAUGE	PAN PACK	COVER PACK
		QT	L	IN	CM	IN	CM	IN	CM			
EWA1	EWC1	1 1/2	1.4	6 1/4	15.9	5 1/4	13.3	4	10.2	12	12	12
EWA2	EWC2	2 3/4	2.6	8	20.3	6 1/4	15.9	4 1/2	11.4	12	12	12
EWA3	EWC3	3 3/4	3.5	8 3/4	22.2	6 3/4	17.2	4 1/2	11.4	12	6	12
EWA4	EWC4	4 1/4	4.3	9 1/2	25.1	7 1/4	18.4	5	12.7	12	6	12
EWA5	EWC10	5 1/2	5.2	9 3/4	24.8	7 3/4	19.7	5 1/2	13.9	12	6	12
EWA7	EWC7	7	6.6	10 1/2	26.7	8 3/4	22.2	5 1/2	13.9	12	6	12
EWA8	EWC8	8 1/2	8	11 3/4	29.8	9 5/8	24.5	5 3/4	14.6	12	6	12
EWA10	EWC20	10	9.5	12 1/8	30.8	10 1/2	26.6	6	15.2	10	5	12



PROFESSIONAL ALUMINUM NON-STICK SAUCE PANS

Building upon the strengths of our natural finish pans, the aluminum non-stick sauce pans add the finest in Teflon® performance. This brings the ease of use and practicality of this product to an even higher level.

ITEM	COVERS TO FIT	CAPACITY		TOP		BOTTOM		HEIGHT		GAUGE	PAN PACK	COVER PACK
		QT	L	IN	CM	IN	CM	IN	CM			
SEWA1	EWC1	1 1/2	1.4	6 1/4	15.9	5 1/4	13.3	4	10.2	12	12	12
SEWA2	EWC2	2 3/4	2.6	8	20.3	6 1/4	15.9	4 1/2	11.4	12	12	12
SEWA3	EWC3	3 3/4	3.5	8 3/4	22.2	6 3/4	17.2	4 1/2	11.4	12	6	12
SEWA4	EWC4	4 1/4	4.3	9 1/2	25.1	7 1/4	18.4	5	12.7	12	6	12
SEWA5	EWC10	5 1/2	5.2	9 3/4	24.8	7 3/4	19.7	5 1/2	13.9	12	6	12
SEWA7	EWC7	7	6.6	10 1/2	26.7	8 3/4	22.2	5 1/2	13.9	12	6	12
SEWA8	EWC8	8 1/2	8	11 3/4	29.8	9 5/8	24.5	5 3/4	14.6	12	6	12
SEWA10	EWC20	10	9.5	12 1/8	30.8	10 1/2	26.6	6	15.2	10	5	12



ALUMINUM FRY BOTTOM

Stove-top frying has never been easier than with our .080" (2 mm) hard sheet aluminum fry bottoms. Their tapered sides, rounded corners, and stamped uprights are designed for balance and efficiency. They may be used with Alegacy fry baskets: B090, B0100 and B0120, pictured on page 28.

ITEM	CAPACITY		TOP		BOTTOM		HEIGHT		GAUGE	PACK
	QT	L	IN	CM	IN	CM	IN	CM		
EWAH5	5 1/2	5.2	9 3/4	24.8	7 3/4	19.7	5 1/2	13.9	12	6
EWAH7	7	6.6	10 1/2	26.7	8 3/4	22.2	5 1/2	13.9	12	6
EWAH8	8 1/2	8	11 3/4	29.8	9 5/8	24.5	5 3/4	14.6	12	6

Professional Aluminum Braziers

Suited for every chef's needs, our variety of best-selling standard braziers or heavy weights will get the job done. All are made from heavy gauge aluminum with smooth, straight side walls, rounded corners, flat bottoms, and a highly polished finish. The low side wall and wide body design provide excellent heat distribution and retention, perfect for long simmering. The handles are four-riveted, extra heavy-duty plated steel that easily carry the load of heavier foods.



STANDARD WEIGHT ALUMINUM BRAZIER

The Eagleware standard weight braziers are perfect for browning meats, simmering or extended cooking times. Available in five nesting sizes and with lids.

ITEM	WITH COVERS	CAPACITY		INSIDE DIAMETER		INSIDE DEPTH		GAUGE	COVER TO FIT	PACK
		QT	L	IN	CM	IN	CM			
EWBR7	EWBR7WC	7	6.6	10	25.4	5	12.7	8	EWC10	2
EWBR10	EWBR10WC	10	9.5	12	30.5	5.1	12.9	8	EWC20	2
EWBR15	EWBR15WC	15	14.2	14	35.6	5.6	14.3	8	EWC40	2
EWBR18	EWBR18WC	18	17	16	40.6	5.2	13.1	6	EWC60	1
EWBR24	EWBR24WC	24	22.7	19	48.3	4.9	12.4	6	EWC80	1

HEAVY-DUTY ALUMINUM BRAZIER

The extra heavy gauge aluminum body offers improved durability and superior heat distribution. Stepped side walls, improved polish finish, and extra heavy-duty plated steel handles make these an easy choice for more rigorous kitchen use. Available in five nesting sizes and with lids.



ITEM	WITH COVERS	CAPACITY		INSIDE DIAMETER		INSIDE DEPTH		GAUGE	COVER TO FIT	PACK
		QT	L	IN	CM	IN	CM			
EWBR207	EWBR207WC	7	6.6	10	25.4	5	12.7	4	EWC10	2
EWBR210	EWBR210WC	10	9.5	12	30.5	5.1	12.9	4	EWC20	2
EWBR215	EWBR215WC	15	14.2	14	35.6	5.6	12.9	4	EWC40	2
EWBR218	EWBR218WC	18	17	16	40.6	5.2	13.1	4	EWC60	1
EWBR224	EWBR224WC	24	22.7	19	48.3	4.9	12.4	4	EWC80	1



PROFESSIONAL ALUMINUM DOUBLE BOILERS

A professional double boiler is essential for preparing delicate sauces and scorch-proof liquids. Our double boilers boast a snug fit that speeds up cooking time while reducing heat loss. The insets and pots have a completely polished finish and are made of heavy gauge .125" (3 mm) aluminum alloy. They are offered in three convenient sizes with a cover. Insets are available as a replacement item.



ITEM	INSETS ONLY	CAPACITY		INSIDE DIAMETER		INSIDE DEPTH		GAUGE	PACK
		QT	L	IN	CM	IN	CM		
EWDB10	EWDBI10	8 1/2	8	10	25.4	7 3/8	18.7	8	1
EWDB12	EWDBI12	11	10.4	10	25.4	9	22.9	8	1
EWDB20	EWDBI20	17 1/2	16.6	12	30.5	10	25.4	8	1

COVERS

Snug fitting covers are imperative for a commercial kitchen. Ours are made of extra thick gauge 3004 aluminum alloy with securely riveted plated steel handles. They are designed to fit Eagleware cookware.



ITEM	IN	CM	GAUGE	PACK
EWC10	10	25.4	12	12
EWC20	12	30.5	12	12
EWC40	14	35.6	12	12
EWC60	16	40.6	12	12
EWC80	19	48.3	12	12

PROFESSIONAL ALUMINUM SAUTÉ PANS

Professional chefs know the value of a well-designed sauté pan. Ours feature heavy gauge aluminum and flat bottoms to ensure even heat distribution, while the rounded corners and large, heavy, steel handles make them easy to work with. Three heavy aluminum rivets securely attach the handle, which has an eye for hanging and an EagleGrip™ insulating grip for enhanced heat protection and slippage prevention. Available in three nesting sizes.

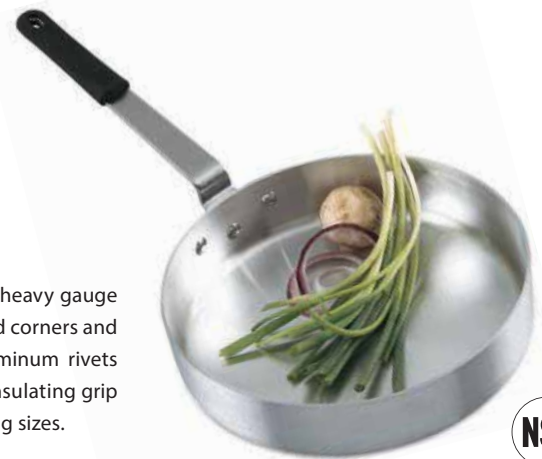

ITEM	CAPACITY		INSIDE DIAMETER		INSIDE DEPTH		GAUGE	COVER TO FIT	PACK
	QT	L	IN	CM	IN	CM			
EWP3	3	2.8	10	25.4	2 3/8	6	8	EWC10	2
EWP5	5	4.7	12	30.5	2 5/8	6.7	8	EWC20	2
EWP7	7	6.6	14	35.6	2 7/8	7.3	8	EWC40	2

The Point-Two-Five-Line™ Heavy-Duty Cookware

With an extra thick, dent-resistant aluminum alloy up to 1/4" wide, these Eagleware® heavy-duty stock pots and pans have the strength and durability required in high-volume kitchens. Extra-heavy rivets attach the sturdy handle to easily withstand the loads they were built to carry. With cookware this strong, you'll only have to order once.



STOCK POTS

ITEM	WITH COVER	CAPACITY		INSIDE DIAMETER		INSIDE DEPTH		GAUGE	COVER TO FIT	PACK
		QT	L	IN	CM	IN	CM			
EW2510	EW2510WC	10	9.5	10	25.4	7 5/8	19.4	2	EWC10	1
EW2512	EW2512WC	12	11.4	10	25.4	9	22.9	2	EWC10	1
EW2520	EW2520WC	20	18.9	12	30.5	10 5/8	27	2	EWC20	1
EW2532	EW2532WC	32	30.3	14	35.6	11 5/8	29.5	2	EWC40	1
EW2540	EW2540WC	40	37.9	14	35.6	15	38.1	2	EWC40	1
EW2560	EW2560WC	60	56.8	16	40.6	17 1/2	44.5	2	EWC60	1

SAUCE POTS

Brushed finish aluminum walls promote even heat distribution, making these pots perfect for simmering. The beadless rim makes cleaning easy and will not trap food particles.

ITEM	WITH COVER	CAPACITY		INSIDE DIAMETER		INSIDE DEPTH		GAUGE	COVER TO FIT	PACK
		QT	L	IN	CM	IN	CM			
EW2506	EW2506WC	6	5.7	10	25.4	4 1/2	11.4	2	EWC10	1
EW250812	EW250812WC	8 1/2	8	10	25.4	6 3/8	16.2	2	EWC10	1
EW25010	EW25010WC	10	9.5	12	30.5	5 1/4	13.3	2	EWC20	1
EW2514	EW2514WC	14	13.2	12	30.5	7 1/2	19.1	2	EWC20	1



FRY PANS

These contoured fry pans are well-balanced and boast specially designed handles to ensure control and ease in handling. The extra-thick aluminum alloy guarantees maximum durability.



ITEM	TOP		BOTTOM		INSIDE DEPTH		GAUGE	PACK
	IN	CM	IN	CM	IN	CM		
EWF3018	7	17.8	4 3/4	12.1	1 1/2	3.8	2	1
EWF3020	8	20.3	5 3/4	14.6	1 7/8	4.8	2	1
EWF3025	10	25.4	7 5/8	19.4	2	5.1	2	1
EWF3030	12	30.5	9 3/4	24.8	2 1/4	5.7	2	1



SAUTÉ PANS

Durable straight wall construction and a brushed finish ensure even heat distribution and make these heavy-duty sauté pans ideal for stove top browning and simmering.



ITEM	CAPACITY		INSIDE DIAMETER		INSIDE DEPTH		GAUGE	COVER TO FIT	PACK
	QT	L	IN	CM	IN	CM			
EWP253	3	2.8	10	25.4	2 3/8	6	2	EWC10	1
EWP255	5	4.7	12	30.5	2 5/8	6.7	2	EWC20	1
EWP257	7	6.6	14	35.6	2 7/8	7.3	2	EWC40	1



SAUCE PANS

Straight walled sauce pans are perfect for simmering gravies, sauces, and hot cereal. They have a satin finish exterior and interior, with a stamped steel plated handle.

ITEM	CAPACITY		INSIDE DIAMETER		INSIDE DEPTH		GAUGE	PACK
	QT	L	IN	CM	IN	CM		
EWA251	1 1/2	1.4	7	17.8	2 1/4	5.7	2	1
EWA253	3	2.8	8 5/8	21.8	3	7.6	2	1
EWA255	5	4.7	9 1/4	23.5	4 1/4	10.8	2	1

Bun & Biscuit Pans

All bun pans are not created equal. Ours are at the top of the list, featuring strong wire-reinforced rims and a high quality surface finish aluminum alloy with fully rounded corners for easy release and cleaning. Ideal for baking or display and fits standard bakers' racks. Choose from a wide variety of thicknesses to fit your needs. Also now available in perforated quarter, half and full size pans for special baking applications.



Wire Reinforced Rims

Perforated

BUN & BISCUIT PANS

Aluminum bun and biscuit pans are available in standard sizes (full, half, quarter and eighth). The 20 gauge is .032" (.8 mm) thick aluminum, the 19 gauge is .036" (.9 mm) thickness, the 18 gauge is .040" (1 mm) thickness, and the 16 gauge is .051" (1.3 mm) thickness. Also now available in quarter, half and full size perforated (1/8" diameter, 3.2 mm) pans for air circulation during baking.

ITEM	DESCRIPTION	IN	CM	GAUGE	PACK
81818	Eighth Size	6 x 10 x 1	15.2 x 25.4 x 2.5	18	12
41814	Quarter Size	9 5/8 x 13 x 1	24.4 x 33 x 2.5	18	12
41814P	Perforated Quarter Size	9 5/8 x 13 x 1	24.4 x 33 x 2.5	18	12
31813	Half Size	12 7/8 x 17 3/4 x 1	32.7 x 45.1 x 2.5	18	12
31813P	Perforated Half Size	12 7/8 x 17 3/4 x 1	32.7 x 45.1 x 2.5	18	12
61826-32	Full Size	18 x 26 x 1	45.7 x 66 x 2.5	20	12
61826-36	Full Size	18 x 26 x 1	45.7 x 66 x 2.5	19	12
61826-40	Full Size	18 x 26 x 1	45.7 x 66 x 2.5	18	12
61826-40P	Perforated Full Size	18 x 26 x 1	45.7 x 66 x 2.5	18	12
61826-51	Full Size	18 x 26 x 1	45.7 x 66 x 2.5	16	12

BUN PAN COVERS

Snug fitting to protect baked goods and also allows for easy stacking of pans with product.

ITEM	DESCRIPTION	IN	CM	PACK
31813C	Half Size	18 3/8 x 13 x 1 1/2	46.7 x 33 x 3.8	12
61826C	Full Size	26 1/4 x 18 1/4 x 1 1/2	66.7 x 46.4 x 3.8	12

BUN PAN GRATES

Enhance the art of baking with our chrome wire grates made of thick gauge material that raise your baked goods off the surface of the pan and allow for maximum unobstructed cooking area.

ITEM	DESCRIPTION	IN	CM	PACK
WRG1612	Half Size	11 1/2 x 16 1/2	29.2 x 41.9	12
WRG1624	Full Size	16 1/2 x 24 1/2	41.9 x 62.2	12

61826C





EAGLEWARE® PROFESSIONAL ALUMINUM PIZZA TRAYS

Five varieties with the Eagleware trademark of quality, durability, and versatility. The thickness keeps them sturdy for extensive use and good looks, making them perfect for dining presentation. The "A" and "HA" series are standard sloped rim trays, "FHA" is our flat rim tray, and "HSA" and the "SA" series are continental "coupe" rim trays. They are made of .032" (.8 mm) and .040" (1 mm) (heavy-duty) thick aluminum alloy. The edges are rolled to eliminate the problem of hard-to-clean openings.



HA, A Construction

.032" THICKNESS

ITEM	DIAMETER		
	IN	CM	PACK
A8	8	20.3	12
A9	9	22.9	12
A10	10	25.4	12
A11	11	27.9	12
A12	12	30.5	12
A13	13	33	12
A14	14	35.6	12
A15	15	38.1	12
A16	16	40.6	12
A17	17	43.2	12

.040" THICKNESS

ITEM	DIAMETER		
	IN	CM	PACK
HA7	7	17.8	12
HA8	8	20.3	12
HA9	9	22.9	12
HA10	10	25.4	12
HA11	11	27.9	12
HA12	12	30.5	12
HA13	13	33	12
HA14	14	35.6	12
HA15	15	38.1	12
HA16	16	40.6	12
HA17	17	43.2	12



FHA Construction

.032" THICKNESS

ITEM	DIAMETER		
	IN	CM	PACK
SA11	11	27.9	12
SA13	13	33	12
SA15	15	38.1	12
SA17	17	43.2	12

.040" THICKNESS

ITEM	DIAMETER		
	IN	CM	PACK
HSA11	11	27.9	12
HSA13	13	33	12
HSA15	15	38.1	12
HSA17	17	43.2	12



HSA, SA Construction

.040" THICKNESS

ITEM	DIAMETER		
	IN	CM	PACK
FHA8	8	20.3	12
FHA9	9	22.9	12
FHA10	10	25.4	12
FHA11	11	27.9	12
FHA12	12	30.5	12
FHA13	13	33	12
FHA14	14	35.6	12
FHA15	15	38.1	12
FHA16	16	40.6	12
FHA17	17	43.2	12



FHA



HSA, SA

Optima[®] Three Aluminum Cookware

Alegacy is proud to introduce the next evolution in its Optima line of cookware, Optima III. Made of 1100 and 3000 series alloy aluminum, the Optima III line is a great alternative to top of the line Eagleware[®]. Though slightly softer, Optima III still offers superior durability and dent-resistance compared to lesser alloys at a comparable price. Its three and four-riveted aluminum handles far outlast welded handle competitors. And, the solid aluminum construction produces efficient, evenly distributed heat across the entire cooking surface. A kitchen outfitted with Optima III will have food that cooks more consistently and economical cookware that performs at the highest level.

 All items on this page are part of our economy line offerings, identified by our green e-line icon and matching color-coded chart items.



OPTIMA III ALUMINUM STOCK POTS

4 mm 1100 alloy aluminum construction with straight sidewalls and satin finish for optimal heat distribution. Four-riveted aluminum handles increase durability and make ideal for a range of cooking and storage usages.

ITEM	CAPACITY		INSIDE DIAMETER		INSIDE DEPTH		GAUGE	COVER TO FIT	PACK
	QT	L	IN	CM	IN	CM			
 AP10	10	9.5	9 1/2	24.1	8 1/4	21	8	APC10	1
AP12	12	11.4	10	25.4	9 1/4	23.5	8	APC12	1
AP16	16	15.1	11	27.9	10	25.4	8	APC16	1
AP20	20	18.9	12	30.5	11	27.9	8	APC20	1
AP24	24	22.7	12 1/2	31.8	11 3/8	28.9	8	APC24	1
AP32	32	30.3	14	35.6	13	33	8	APC32	1
AP40	40	37.9	14 1/2	36.8	14 1/4	36.2	8	APC40	1
AP60	60	56.8	17 1/4	43.8	16	40.6	8	APC60	1
AP80	80	75.7	19	48.3	16 3/4	42.5	8	APC80	1

OPTIMA III ALUMINUM STOCK POT COVERS

Designed for the Optima III stock pot, our covers, made of 1100 alloy aluminum, create a thermal seal that reduces heat loss and speeds up cooking time.

ITEM	IN	CM	GAUGE	FITS POT	PACK
 APC10	9 1/2	24.1	14	AP10	6
APC12	10	25.4	13	AP12	6
APC16	11	27.9	13	AP16	6
APC20	12	30.5	13	AP20	6
APC24	12 1/2	31.8	13	AP24	6
APC32	14	35.6	13	AP32	6
APC40	14 1/2	36.8	13	AP40	6
APC60	17 1/4	43.8	13	AP60	6
APC80	19	48.3	13	AP80	6





OPTIMA III ALUMINUM SAUCE POTS

Optima's 1100 alloy aluminum and smooth satin finish create the ideal environment for simmering sauces, with a heat transfer that is consistent and responsive. Four-riveted handles make for safe and secure handling of a heavily laden pot.

ITEM	CAPACITY		INSIDE DIAMETER		INSIDE DEPTH		GAUGE	COVER TO FIT	PACK
	QT	L	IN	CM	IN	CM			
 ASP14	14	13.2	12	30.5	7 3/8	18.7	8	ASPC14	1
ASP20	20	18.9	13	33	9	22.9	8	ASPC20	1
ASP26	26	24.6	14	35.6	9 5/8	24.4	8	ASPC26	1
ASP34	34	32.2	16	40.6	9 5/8	24.4	8	ASPC34	1
ASP40	40	37.9	18	45.7	9 5/8	24.4	8	ASPC40	1

OPTIMA III ALUMINUM SAUCE POT COVERS

Designed for the Optima III sauce pot, our covers, made of 1100 alloy aluminum, create a steam tight fit that locks in flavor and maintains heat consistency.



ITEM	IN	CM	GAUGE	FITS POT	PACK
 ASPC14	12	30.5	13	ASP14	6
ASPC20	13	33	13	ASP20	6
ASPC26	14	35.6	14	ASP26	6
ASPC34	16	40.6	13	ASP34	6
ASPC40	18	45.7	13	ASP40	6

OPTIMA III ECONOMY ALUMINUM BUN PANS

Available in a variety of sizes, 1060 alloy aluminum.

ITEM	DESCRIPTION	IN	CM	GAUGE	PACK
 86100E	Eighth Size	6 x 10 x 1	15.2 x 25.4 x 2.5	20	12
41814E	Quarter Size	9 5/8 x 13 x 1	24.4 x 32.7 x 2.5	20	12
31813E	Half Size	13 x 17 3/4 x 1	32.7 x 45.1 x 2.5	20	12
61622-40E	Two-Third Size	12 7/8 x 17 3/4 x 1	32.7 x 45.1 x 2.5	19	12
61826-36E	Full Size	18 x 26 x 1	45.7 x 66 x 2.5	19	12
61826-40E	Full Size	18 x 26 x 1	45.7 x 66 x 2.5	18	12
31813PE	Perforated Half Size	18 x 26 x 1	45.7 x 66 x 2.5	20	12
61826-40PE	Perforated Full Size	12 7/8 x 17 3/4 x 1	32.7 x 45.1 x 2.5	18	12



PERFORATED



 All items on this page are part of our economy line offerings, identified by our green e-line icon and matching color-coded chart items.

OPTIMA® III NATURAL ALUMINUM FRY PANS

3000 series alloy aluminum, an all satin finish and three-riveted handles make these durable pans a must-have for any commercial kitchen. The stamped handle also has an eye for easy stowing.



ITEM	TOP		BOTTOM		INSIDE DEPTH		GAUGE	PACK
	IN	CM	IN	CM	IN	CM		
e™ AFP18	7	18	4 3/4	12.1	1 1/2	3.8	8	6
AFP20	8	20	5 1/2	14	1 3/4	4.4	8	6
AFP25	10	25	7 5/8	19.4	1 7/8	4.8	7	6
AFP30	12	30	9 3/4	24.8	2 1/4	5.7	7	6
AFP35	14	35	11	27.9	2 1/2	6.4	7	6



e™ All items on this page are part of our economy line offerings, identified by our green e-line icon and matching color-coded chart items.

OPTIMA III NON-STICK ALUMINUM FRY PANS

All of the strength and durability of the natural fry pans comes together with the performance of a Quantum® finish that delivers superior release efficiency.

ITEM	TOP		BOTTOM		INSIDE DEPTH		GAUGE	PACK
	IN	CM	IN	CM	IN	CM		
e™ AFPQ18	7	18	4 3/4	12.1	1 1/2	3.8	8	6
AFPQ20	8	20	5 1/2	14	1 3/4	4.4	8	6
AFPQ25	10	25	7 5/8	19.4	1 7/8	4.8	7	6
AFPQ30	12	30	9 3/4	24.8	2 1/4	5.7	7	6
AFPQ35	14	35	11	27.9	2 1/2	6.4	7	6

OPTIMA III NATURAL & NON-STICK ALUMINUM FRY PANS WITH INSULATING GRIP

This pan's Natural and Eclipse® non-stick finish is elevated even higher with the addition of an insulating grip, which puts cooking comfort, safety and efficiency in your hands.



NATURAL	NONSTICK	TOP		BOTTOM		INSIDE DEPTH		GAUGE	PACK
ITEM	ITEM	IN	CM	IN	CM	IN	CM		
e™ AFP18G	AFPE18G	7	18	4 3/4	12.1	1 1/2	3.8	8	6
AFP20G	AFPE20G	8	20	5 1/2	14	1 3/4	4.4	8	6
AFP25G	AFPE25G	10	25	7 5/8	19.4	1 7/8	4.8	7	6
AFP30G	AFPE30G	12	30	9 3/4	24.8	2 1/4	5.7	7	6
AFP35G	AFPE35G	14	35	11	27.9	2 1/2	6.4	7	6

* Quantum® and Eclipse® are Whitford Corporation's registered trademarks for their non-stick surfaces.



eTM All items on this page are part of our economy line offerings, identified by our green e-line icon and matching color-coded chart items.

OPTIMA III ALUMINUM SAUCE PANS

Straight walled, satin finished aluminum construction and riveting makes for a dependable and even heating pan for any sauce or gravy imaginable.



ITEM	CAPACITY		TOP		BOTTOM		HEIGHT		GAUGE	COVER TO FIT	PACK
	QT	L	IN	CM	IN	CM	IN	CM			
e ™ APS1	1.5	1.4	6	15.2	5	12.7	3 1/2	8.9	10	APSC1	12
APS2	2.75	2.6	7 5/8	19.4	6	15.2	4	10.2	9	APSC2	12
APS3	3.75	3.5	9	22.9	7 1/2	19.1	4	10.2	9	APSC3	12
APS4	4.5	4.2	9	22.9	7 1/2	19.1	5	12.7	9	APSC4	12
APS5	5.5	5.2	9 3/4	24.8	8 1/2	21.6	5	12.7	9	APSC5	12
APS7	7	6.6	10 1/2	26.7	8 1/2	21.6	5 1/4	13.3	9	APSC7	6
APS10	10	9.5	11 1/2	29.2	9 3/4	24.8	5 1/2	14	9	APSC10	6



OPTIMA III ALUMINUM SAUCE PAN COVERS

Designed for the Optima III sauce pan, our covers, made of 1100 alloy aluminum, create a fit that locks in flavor and maintains heat consistency.

ITEM	IN	CM	GAUGE	FITS PAN	PACK
e ™ APS1	6	15.2	19	APS1	6
APS2	7 5/8	19.4	16	APS2	6
APS3	9	22.9	16	APS3	6
APS4	9	22.9	16	APS4	6
APS5	9 3/4	24.8	17	APS5	6
APS7	10 1/2	26.7	17	APS7	6
APS10	11 1/2	29.2	14	APS10	6



OPTIMA III ALUMINUM BRAZIER

Even heat distribution and thermal conductivity make these braziers ideal for browning, simmering and more. Heavy-duty construction and rivets make it great for any bustling kitchen.

ITEM	CAPACITY		INSIDE DIAMETER		INSIDE DEPTH		GAUGE	COVER TO FIT	PACK
	QT	L	IN	CM	IN	CM			
e ™ ABR15	15	14.2	14	35.6	6	15.2	8	APC32	1
ABR18	18	17.1	16	40.6	5 1/4	13.3	8	APC34	1
ABR24	24	22.7	17	43.2	5 3/8	13.7	8	APC60	1

OPTIMA III ALUMINUM SAUTÉ PANS

Its flat aluminum bottom and rounded corners create a chef's ideal sautéing surface. Coupled with the sturdy three-riveted handle this pan is consistent, easy-to-use and durable.

ITEM	CAPACITY		INSIDE DIAMETER		INSIDE DEPTH		GAUGE	COVER TO FIT	PACK
	QT	L	IN	CM	IN	CM			
e ™ ASTP3	3	2.8	9 3/4	24.8	2 3/8	6	8	APC10	1
ASTP5	5	4.7	11 3/4	29.8	2 3/8	6	8	APC20	1
ASTP7	7	6.6	13 3/4	34.9	2 3/4	7	8	APC32	1



Optima[®] and Optima[®] Two Stainless Steel Cookware

The Optima and Optima II set the standard for quality, economical stainless steel cookware. The Optima line's .8 mm to 1.2 mm thick body is ideal for alternative uses, such as storing prepared foods or cooking highly acidic items that otherwise compromise a lesser grade aluminum. The up to 5 mm aluminum bottom makes for improved heat distribution. Several items are also available with a sandwiched bottom of aluminum and .8 mm 18/0 stainless steel, making them induction ready. For exceptional durability, the 18/8 stainless steel boasts superb corrosion resistance and is built to last in a bustling commercial kitchen. For the economical kitchen operator, Optima II's 21CT material offers a standard level of corrosion resistance at an outstanding price.



STAINLESS STEEL STOCK POTS WITH COVERS

.8 mm to 1.2 mm 18/8 or 21CT S/S satin polished pots are excellent for a variety of cooking and storage applications.

18/8 ITEM	21CT  ITEM	CAPACITY		INSIDE DIAMETER		INSIDE DEPTH		PACK
		QT	L	IN	CM	IN	CM	
SSSP8*	21SSSP8*	8	7.5	9 1/2	24.3	6 5/8	16.8	1
SSSP12*	21SSSP12*	12	11.4	11	27.9	7	17.8	1
SSSP16*	21SSSP16*	16	15.1	11	27.9	10 3/16	25.9	1
SSSP20*	21SSSP20*	20	18.9	11 7/8	30.2	10 1/8	25.7	1
SSSP24	21SSSP24	24	22.7	13 3/16	33.5	10 3/4	27.3	1
SSSP32	21SSSP32	32	30.3	14 1/4	36.2	11 3/4	29.8	1
SSSP40	21SSSP40	40	37.9	15 3/4	40.1	11 7/8	30.2	1
SSSP60	21SSSP60	60	56.8	17 3/4	45	14 3/16	36	1
SSSP80	21SSSP80	80	75.7	19 3/8	50	15 3/4	40	1
SSSP100	21SSSP100	100	94.6	19 3/4	50.2	19 1/2	49.5	1

*Induction ready



Economy line offerings are identified by our green e-line icon and matching color-coded chart items.



STAINLESS STEEL COVERS

S/S covers to fit all sizes of pots listed.

18/8	21CT 	DIAMETER		
ITEM	ITEM	IN	CM	PACK
SSSPL8	21SSSPL8	9 1/2	24.3	12
SSSPL1216	21SSSPL1216	11	27.9	12
SSSPL20	21SSSPL20	11 7/8	30.2	12
SSSPL24	21SSSPL24	13 3/16	33.5	12
SSSPL32	21SSSPL32	14 1/4	36.2	12
SSSPL40	21SSSPL40	15 3/4	40.1	12
SSSPL60	21SSSPL60	17 3/4	45	12
SSSPL80100	21SSSPL80100	19 3/4	50.2	12



Economy line offerings are identified by our green e-line icon and matching color-coded chart items.

STAINLESS STEEL SAUCE PANS WITH COVERS

.8 mm thick 18/8 or 21CT S/S sauce pans with a 5 mm aluminum and .8 mm 18/0 S/S sandwiched bottom.

18/8	21CT 	CAPACITY		TOP		HEIGHT		
ITEM	ITEM	QT	L	IN	CM	IN	CM	PACK
	21SSSP1*	1	.9	5 1/2	14	2 1/2	6.3	1
SSSP2*	21SSSP2*	2	1.9	6 1/4	16	3 3/4	9.6	1
SSSP3*	21SSSP3*	3.5	3.3	7 7/8	20	4 1/8	10.5	1
SSSP4*	21SSSP4*	4.5	4.2	7 7/8	20	5 1/2	14	1
SSSP6*	21SSSP6*	6	5.6	9 1/2	24.1	4 7/8	12.4	1
SSSP7*	21SSSP7*	7.5	7.1	9 1/2	24.1	6	15.2	1
SSSP10*	21SSSP10*	10	9.5	11	27.9	6	15.2	1

*Induction ready



STAINLESS STEEL BRAZIERS WITH COVERS

.8 mm to 1.2 mm 18/8 or 21CT S/S satin polished braziers are excellent for storage and certain long cooking applications. Available in four convenient sizes.

18/8	21CT 	CAPACITY		INSIDE DIAMETER		INSIDE DEPTH		
ITEM	ITEM	QT	L	IN	CM	IN	CM	PACK
SSBR15	21SSBR15	15	14.2	14 1/4	36.2	5 3/8	13.7	1
SSBR20	21SSBR20	20	18.9	15 3/4	40	5 3/4	14.6	1
SSBR25	21SSBR25	25	9.9	17 3/4	45	5 7/8	14.9	1
SSBR30	21SSBR30	30	27.5	19 3/4	50.1	6	15.2	1



STAINLESS STEEL FRY PANS

.8 mm to 1 mm thick fry pans with 3 mm aluminum and .8 mm 18/0 S/S sandwiched bottom for induction.

18/8 ITEM	21CT  ITEM	TOP		BOTTOM		INSIDE DEPTH		PACK
		IN	CM	IN	CM	IN	CM	
SSFP8*	21SSFP8*	8	20.3	5 1/2	13.9	1 3/4	4.4	1
SSFP9*	21SSFP9*	9 1/2	24.1	7	17.8	1 3/4	4.4	1
SSFP11*	21SSFP11*	11	28	8 5/8	22	2	5	1
SSFP12	21SSFP12	12 5/8	2	10 1/4	26	2	5	1
SSFP14	21SSFP14	14 1/4	36.2	11 7/8	30.2	2 1/4	5.7	1

*Induction ready



TEFLON[®] XTRA STAINLESS STEEL FRY PANS

.8 mm to 1 mm thick fry pans with 3 mm aluminum and .8 mm 18/0 sandwiched bottom. Each fry pan has a Teflon Xtra interior finish that provides non-stick quick release capabilities.

18/8 ITEM	21CT  ITEM	TOP		BOTTOM		INSIDE DEPTH		PACK
		IN	CM	IN	CM	IN	CM	
SSFPC8*	21SSFPC8*	8	20.3	5 1/2	13.9	1 3/4	4.4	1
SSFPC9*	21SSFPC9*	9 1/2	24.1	7	17.8	1 3/4	4.4	1
SSFPC11*	21SSFPC11*	11	28	8 5/8	22	2	5	1
SSFPC12	21SSFPC12	12 5/8	32	10 1/4	26	2	5	1
SSFPC14	21SSFPC14	14 1/4	36.2	11 7/8	30.2	2 1/4	5.7	1

*Induction ready



STAINLESS STEEL FRY PAN WITH TWO HANDLES

1 mm thick fry pans with 3 mm aluminum and .8 mm 18/0 S/S sandwiched bottom and dual welded hand handles, make for superior ease of use. Cover included.

21CT  ITEM	CAPACITY		INSIDE DIAMETER		INSIDE DEPTH		PACK
	QT	L	IN	CM	IN	CM	
21SSSP29	2 3/4	2.6	9 1/2	24.1	2 5/16	5.9	1
21SSSP211	3 3/4	3.5	11	27.9	2 3/8	6	1
21SSSP213	5	4.7	12 5/8	32	2 1/2	6.3	1

 Economy line offerings are identified by our green e-line icon and matching color-coded chart items.

STAINLESS STEEL SAUTÉ PANS

Available in three convenient sizes for browning and preparation of sautéed foods.

18/8 ITEM	21CT  ITEM	CAPACITY		INSIDE DIAMETER		INSIDE DEPTH		PACK
		QT	L	IN	CM	IN	CM	
SSSTP3	21SSSTP3	3	2.8	10 1/4	26	3 1/8	7.9	1
SSSTP5	21SSSTP5	5	4.4	11 7/8	30.2	2 3/4	7	1
SSSTP7	21SSSTP7	7	6.3	14 1/4	36.2	2 3/4	7	1





STAINLESS STEEL PASTA COOKER

8mm thick 21CT satin polished pasta cooker allows for results al dente. Cover included.



ITEM	CAPACITY		INSIDE DIAMETER		INSIDE DEPTH		COVER TO FIT	PACK
	QT	L	IN	CM	IN	CM		
 21SSPC8	8	7.5	9 ½	24.1	6 ¾	17.5	21SSDBC8	1
21SSPC12	12	11.4	10	25.4	8 ½	21.6	21SSDBC12	1
21SSPC16	16	15.1	11	27.9	9 ¾	24.8	21SSDBC16	1
21SSPC20	20	18.9	12	30.5	11 ½	29.2	21SSDBC20	1



STAINLESS STEEL POT ONLY

ITEM	CAPACITY		INSIDE DIAMETER		INSIDE DEPTH		COVER TO FIT	PACK
	QT	L	IN	CM	IN	CM		
 21SSDBP12	12	11.4	10	25.4	9 ¼	23.5	21SSDBC12	1
21SSDBP20	20	18.9	12	30.5	11 ¼	28.6	21SSDBC20	1



STAINLESS STEEL COVER

ITEM	INSIDE DIAMETER		FITS POT	PACK
	IN	CM		
 21SSDBC8	10	25.4	21SSPC8, 21SSDB8	1
21SSDBC12	10 ¾	27.3	21SSPC12, 21SSDB12	1
21SSDBC16	11 ½	29.2	21SSPC16, 21SSDB16	1
21SSDBC20	12 ¾	31.4	21SSPC20, 21SSDB20	1



STAINLESS STEEL DOUBLE BOILER INSET

ITEM	CAPACITY		INSIDE DIAMETER		PACK
	QT	L	IN	CM	
 21SSDBI12	12	11.4	10 ¼	26	1
21SSDBI20	20	18.9	12	30.5	1

STAINLESS STEEL DOUBLE BOILER

8mm thick 21CT satin plated double boiler, well-suited for preparing delicate sauces and scorch-proof liquids. Cover included.

ITEM	CAPACITY		INSIDE DIAMETER		INSIDE DEPTH		COVER TO FIT	PACK
	QT	L	IN	CM	IN	CM		
 21SSDB8	8	7.5	9 ½	24.1	6 ¾	17.1	21SSDBC8	1
21SSDB12	12	11.4	10 ¼	26	8 ½	21.6	21SSDBC12	1
21SSDB16	16	15.1	11	27.9	9 ¾	24.8	21SSDBC16	1
21SSDB20	20	18.9	12	30.5	10 ¾	27.3	21SSDBC20	1



 All items on this page are part of our economy line offerings, identified by our green e-line icon and matching color-coded chart items.



STOCK POT, LID & ALUMINUM BASKET

This durable aluminum alloy Eagleware® pot transfers heat evenly while the basket allows for circulation of water and easy draining. The set includes pot, basket, and cover.

ITEM	CAPACITY		INSIDE DIAMETER		INSIDE DEPTH		GAUGE	PACK
	QT	L	IN	CM	IN	CM		
EWAB12	12	11.4	10	25.4	9	22.9	8	1
EWAB16	16	15.1	10	25.4	12	30.5	8	1
EWAB20	20	18.9	12	30.5	10 ⁵ / ₈	27	8	1
EWAB24	24	22.7	12	30.5	12 ⁷ / ₁₆	31.6	8	1
EWAB32	32	30.3	14	35.6	11 ⁵ / ₈	29.5	8	1
EWAB40	40	37.9	14	35.6	15	38.1	8	1
EWAB60	60	56.8	16	40.6	17 ¹ / ₂	44.5	6	1
EWAB80	80	75.7	19	48.3	16 ¹ / ₄	41.3	6	1



ALUMINUM BASKETS

The aluminum basket means better heat transfer. The footed bottom allows greater circulation of boiling water to increase efficiency. Baskets fit Eagleware stock pots, as listed below.

ITEM	FITS POT	DIAMETER		HEIGHT		PACK
		IN	CM	IN	CM	
AB12	EW12	9	22.9	8 ¹ / ₂	21.6	1
AB16	EW16	9 ¹ / ₂	24.1	9 ³ / ₄	24.8	1
AB20	EW20	10 ¹ / ₂	26.7	8 ¹ / ₂	21.6	1
AB24	EW24	10 ¹ / ₂	26.7	11	27.9	1
AB32	EW32	12 ¹ / ₄	31.1	9 ³ / ₄	24.8	1
AB40	EW40	12 ¹ / ₄	31.1	13 ¹ / ₄	33.7	1
AB60	EW60	15	38.1	15 ¹ / ₂	39.4	1
AB80	EW80	18	45.7	14 ¹ / ₂	36.8	1

INNER METAL WIRE BASKET WITH HANDLE

Perforated baskets are perfect for steaming and draining. The footed bottom lets boiling water circulate while the bail handle allows for convenient removal, draining, and cleaning.

ITEM	FITS POT	DIAMETER		HEIGHT		PACK
		IN	CM	IN	CM	
EB16	EW16	9	22.9	7	17.8	1
EB20	EW20	11	27.9	7 ¹ / ₂	19	1
EB24	EW24	11	27.9	8 ¹ / ₂	21.6	1
EB32	EW32	13	33	8 ¹ / ₄	21	1
EB40	EW40	13	33	12	30	1
EB60	EW60	14 ³ / ₄	37.5	14 ¹ / ₄	36.2	1
EB80	EW80	17 ³ / ₄	45.1	12 ³ / ₄	32.4	1



PROFESSIONAL ALUMINUM STOCK POTS WITH BASKETS

Essential for steaming or boiling lobster, clams, tamales, or corn-on-the-cob. Eagleware® professional aluminum stock pots with chrome-plated, bail handled straining baskets and covers come in seven sizes.

ITEM	CAPACITY		DIAMETER		DEPTH		GAUGE	PACK
	QT	L	IN	CM	IN	CM		
EWSB16	16	15.1	10	25.4	12	30.5	8	1
EWSB20	20	18.9	12	30.5	10 ⁵ / ₈	27	8	1
EWSB24	24	22.7	12	30.5	12 ⁷ / ₁₆	31.6	8	1
EWSB32	32	30.3	14	35.6	11 ⁵ / ₈	29.5	8	1
EWSB40	40	37.9	14	35.6	15	38.1	8	1
EWSB60	60	56.8	16	40.6	17 ¹ / ₂	44.5	6	1
EWSB80	80	75.7	19	48.3	16 ¹ / ₄	41.3	6	1



PASTA COOKER

This four section pasta cooker is an incredible time and energy saver. It can hold multiple batches of pasta in the same pot of boiling water, which means no more changing water between dishes. The perforated stainless steel baskets transfer heat well and allow even water flow and easy draining. Insets can be hooked on the side wall of the Eagleware pot for draining and they have the EagleGrip™ insulating grip for comfortable and safe lifting.

ITEM		CAPACITY		DIAMETER		DEPTH		GAUGE	PACK
		QT	L	IN	CM	IN	CM		
EWPC18	W/4 SS Insets	12	11.4	14	35.6	6 1/4	15.9	8	1
EW18	Pot Only	18	17	14	35.6	6 7/8	17.5	8	1
EWPC18	Replacement Insets	3	2.8			6 1/4	15.9		1

HEAVY-DUTY ALUMINUM STOCK POTS

Thermally efficient aluminum pots are ideal for extra large cooking operations. Four convenient sizes available: 100 qt, 120 qt, 140 qt and 160 qt. Sold with cover only.



ITEM W/COVER	CAPACITY		INSIDE DIAMETER		INSIDE DEPTH		GAUGE	PACK
	QT	L	IN	CM	IN	CM		
 AP100WC	100	94.6	20 1/4	52.1	17 1/8	43.5	2	1
AP120WC	120	113.5	21 3/4	55.2	19	48.3	2	1
AP140WC	140	132.5	23	58.4	19 7/8	50.5	2	1
AP160WC	160	151.4	23	58.4	23	58.4	2	1

FRENCH STYLE STEEL FRY PANS

These pans are constructed of heavy-duty stamped steel with welded handles. Use them on the stove top, in the oven or in the broiler for excellent performance. To prevent corrosion, we suggest you keep steel fry pans well oiled when not in use.

ITEM	IN	CM	PACK
F16	6 1/2	16.5	12
F18	7 1/4	18.4	12
F20	8	20.3	12
F28	11	27.9	12
F32	12 3/4	32.4	6
F36	14 5/8	37.1	6
F40	15	38.1	6



 Economy line offerings are identified by our green e-line icon and matching color-coded chart items.

WIRE FRY BASKETS

These baskets have a heavy nickel-plated wire frame. The medium mesh wire basket has a securely welded handle and excels in stove-top frying.

ITEM	IN	CM	PACK
B090	8 1/2	21.6	20
B0100	9 1/2	24.1	20
B0120	11 1/2	29.2	20
B0140	13	33	20

WIRE RECTANGULAR FRY BASKET

This fry basket's single wire construction provides impressive durability. Baskets are available with or without plastic handle for easy basket removal. Choose from six models.

ITEM	HANDLE COLOR	IN	CM	PACK
79201	Uncoated	13 x 5 3/8 x 5 5/8	33 x 13.7 x 14.3	1
79204	Green	13 x 5 3/8 x 5 5/8	33 x 13.7 x 14.3	1
79207	Red	13 x 5 3/8 x 5 5/8	33 x 13.7 x 14.3	1
79210	Uncoated	12 1/2 x 6 1/4 x 4 7/8	31.8 x 15.8 x 12.4	1
79213	Green	12 1/2 x 6 1/4 x 4 7/8	31.8 x 15.8 x 12.4	1
79216	Red	12 1/2 x 6 1/4 x 4 7/8	31.8 x 15.8 x 12.4	1



STEEL FRY BOTTOM

This stamped steel pan has a steel upright and handle welded to body of the pan as well as a rolled rim for extra strength. To prevent corrosion, we suggest you keep steel fry pans well oiled when not in use.

ITEM	IN	CM	BASKET TO FIT	PACK
S090	9	22.9	B090	6
S0100	11	27.9	B0100	6
S0120	13	33	B0120	6
S0140	15 1/2	39.4	B0140	6



ALUMINUM BAKE & ROAST PAN

A perfect pan for all-purpose use with a natural finish and riveted, loop handles.



ITEM	IN	CM	PACK
5480	11 3/8 x 17 1/4 x 2 1/4	28.9 x 43.8 x 5.7	12

HEAVYWEIGHT ALUMINUM ROAST PANS

The open bake-roast pan is perfect for poultry and roasts as well as cakes and desserts. Extra thick aluminum allows for even heat distribution and the 3" (7.6 cm) side wall retains food juices. Square loop handles make pans easy to transport. Open bead for easy cleaning.

ITEM	IN	CM	PACK
A12183	12 x 18 x 3 1/2	30.5 x 45.7 x 8.9	6
A14203	14 x 20 x 3 1/2	35.6 x 50.8 x 8.9	6
A18203	18 x 20 x 3 1/2	45.7 x 50.8 x 8.9	6

HEAVY-DUTY ALUMINUM ROAST PANS

This seamless drawn pan and cover are made from tough 3/16" (.5 cm) thick aluminum suited for heavy use. Handles appear on all four sides to ensure easy handling from any angle. Use the cover on the grill as a low pan. The leak-proof and rounded-corner construction make cleaning easy. The 6 3/4" pan has a capacity of up to 172 8-ounce servings. Available in three depths: 3", 4 1/2", and 6 3/4" (7.6 cm, 11.4 cm, and 17.1 cm).



ITEM	DESCRIPTION	IN	CM	PACK
HDAS201735	Set	20 7/8 x 17 3/8 x 4 7/8	53 x 44 x 12.3	1
HDAS20175	Set	20 7/8 x 17 3/8 x 5 7/8	53 x 44 x 14.9	1
HDAS20177	Set	20 7/8 x 17 3/8 x 7	53 x 44 x 17.8	1
HDA201735	Pan Only	20 7/8 x 17 3/8 x 3	53 x 44 x 7.6	1
HDA20175	Pan Only	20 7/8 x 17 3/8 x 4 1/2	53 x 46 x 11.4	1
HDA20177	Pan Only	20 7/8 x 17 3/8 x 6 3/4	53 x 46 x 17.1	1
HDAC21182	Cover Only	21 5/8 x 18 1/8 x 2 1/4	54.9 x 46 x 5.7	1

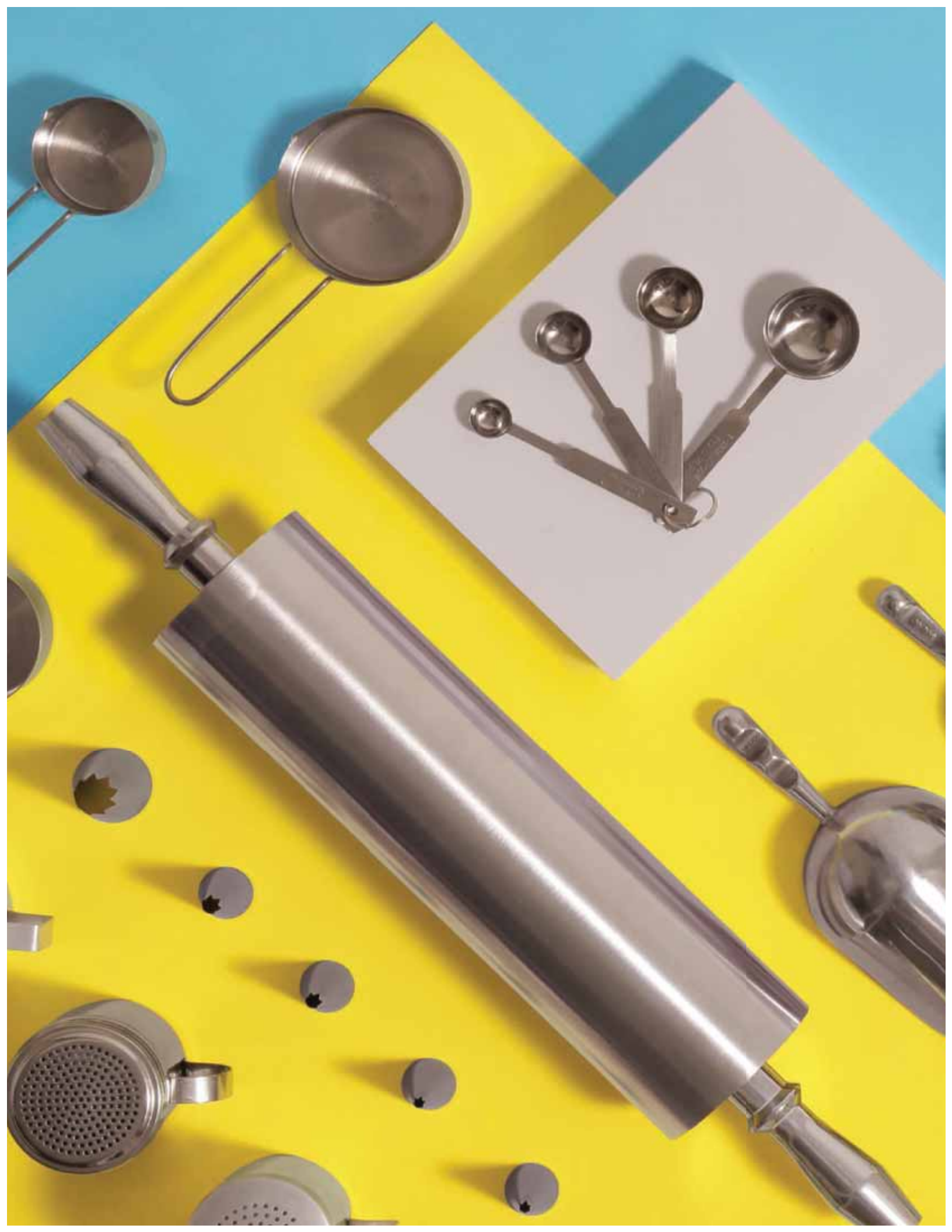

BAKEWARE & SUPPLIES

Measures

32 - 33

Dredges/Sieves

34 - 35

Scoops

36 - 37

Pie/Cake Pans

38 - 39

Pastry Items

40 - 42

Rolling Pins

43

Pastry Cutters

44

Pans

45 - 47



MEASURING CUP SETS

Sets are stainless steel with long, solid and wire handles. Cup sizes: 1/4, 1/3, 1/2 and 1 cup graduated inside/out.

ITEM	PACK
1190MC	12 Sets
1191MC	12 Sets
1191MC14	12 Sets
1191MC13	12 Sets

MEASURING SPOON SET

Stainless steel measuring set in U.S. standard capacities: 1/4, 1/2, 1 teaspoon and 1 tablespoon. Blister carded.

ITEM	MATERIAL	PACK
2318	Stainless Steel	12



MEASURING SPOON SETS

Stainless steel or aluminum in U.S. standard capacities: 1/4, 1/3, 1 teaspoon and 1 tablespoon.

ITEM	MATERIAL	PACK
2314	Aluminum	12
2316	Stainless Steel	12
2316EH	Stainless Steel	12

MEASURING CUP SET

Conveniently designed for stove-top use. Aluminum, short handle, four cup set includes 1/4, 1/3, 1/2 and 1 cup.



ITEM	PACK
ALK66	12 Sets



LIQUID MEASURES

Heavy-duty aluminum with seamless construction, large riveted handles, and capacity markings. Designed for no-spill pouring.

ITEM	CAPACITY		DIAMETER		HEIGHT		PACK
	QT	L	IN	CM	IN	CM	
ML05	1/2	.5	4 1/4	10.8	3 7/8	9.8	1
ML10	1	.9	5 1/8	13	5 1/8	13	1
ML20	2	1.9	6 1/8	15.6	6 5/8	16.8	1
ML40	4	3.8	7 3/8	18.7	8 1/2	21.6	1

DRY MEASURES

Heavy-duty aluminum with seamless construction, large riveted handles, and capacity markings.

ITEM	CAPACITY		DIAMETER		HEIGHT		PACK
	QT	L	IN	CM	IN	CM	
M05	1/2	.5	3 1/2	8.9	3 3/8	8.6	1
M10	1	.9	5 1/8	13	5 1/8	13	1
M20	2	1.9	5 1/8	13	6 1/8	15.6	1
M40	4	3.8	7 3/8	18.7	8 1/2	21.6	1



MEASURING SPOON SET

Stainless steel measuring set in U.S. standard capacities: 1/4, 1/2, 1 teaspoon and 1 tablespoon.

ITEM	MATERIAL	PACK
2315	Stainless Steel	12

LONG HANDLE MEASURING SPOONS

Individual stainless steel measuring spoons in U.S. standard capacities: 1/4, 1/2, 1 teaspoon and 1 tablespoon (1.25 ml, 2.5 ml, 5 ml, 15 ml).

ITEM	PACK
2320-1	12 Sets
2320-2	12 Sets
2320-3	12 Sets
2320-4	12 Sets





STAINLESS STEEL DREDGES

Polished finish and universal holes for dispensing flour, sugar, and more.

ITEM	DESCRIPTION	CAPACITY				PACK
		OZ	ML	IN	CM	
SD2571	Without Handle	12	354.8	2 7/8 x 3 3/4	7.3 x 9.5	12
SDH2571	With Handle	12	354.8	2 7/8 x 3 1/2	7.3 x 8.9	12
SD3571	Without Handle	16	473.1	2 7/8 x 5 1/4	7.3 x 13.3	12
SDH3571	With Handle	16	473.1	2 7/8 x 5 1/4	7.3 x 13.3	12
SD4571	Without Handle	22	650.5	2 7/8 x 7 1/8	7.3 x 18.1	6

ALUMINUM DREDGES

Bright finish and universal holes.



ITEM	DESCRIPTION	CAPACITY				PACK
		OZ	ML	IN	CM	
AL257	With Handle	10	295.7	2 3/4 x 3 5/8	7 x 9.2	12
AL257WO	Without Handle	10	295.7	2 5/8 x 3 1/2	6.7 x 8.9	12
ADH3571	With Handle	13	384.4	2 3/4 x 4	7 x 10.2	12
AD3571	Without Handle	13	384.4	2 3/4 x 4	7 x 10.2	12

STAINLESS STEEL DREDGE

Polished finish with a mesh top for dispensing flour, sugar, and more.



ITEM	DESCRIPTION	CAPACITY				PACK
		OZ	ML	IN	CM	
SD4871	Without Handle	10	295.7	2 3/4 x 3 7/8	7 x 9.8	12



PLASTIC DREDGE

Our clear dredge allows you to see the contents. Universal holes and removable plastic cover aid in easy dispensing and cleanup.

ITEM	DESCRIPTION	CAPACITY				PACK
		OZ	ML	IN	CM	
PD2571	With Handle	10	295.7	2 3/4 x 3 5/8	7 x 9.2	12



STAINLESS STEEL RIM SIEVES

16 mesh wire with two cross-bar wire reinforcers.

ITEM	DIAMETER		HEIGHT		PACK
	IN	CM	IN	CM	
S9908	8	20.3	2 3/4	7	1
S9910	10	25.4	2 3/4	7	1
S9912	12	30.5	2 3/4	7	1
S9914	14	35.6	2 3/4	7	1
S9916	16	40.6	2 3/4	7	1



WOODEN RIM SIEVES

Sieve has 16 mesh wire.

ITEM	DIAMETER		HEIGHT		PACK
	IN	CM	IN	CM	
9810	10	25.4	2 3/4	7	1
9812	12	30.5	2 3/4	7	1
9814	14	35.6	2 3/4	7	1
9816	16	40.6	2 3/4	7	1
9818RS	18	45.7	2 3/4	7	1



STAINLESS STEEL SCOOPS

For both dry and wet products. Scoops have a mirror polished finish outside and inside.

ITEM	CAPACITY		BOWL SIZE		PACK
	OZ	ML	IN	CM	
SS10008	1.5	44.4	3 5/16 x 1 5/8	8.4 x 4.1	12
SS100010	2	59.2	3 3/4 x 2	9.5 x 5.1	12
SS100012	3.5	103.6	4 3/4 x 2 5/16	12 x 5.9	12
SS100014	6	177.6	5 1/2 x 2 3/4	14 x 7	12
SS100015	8	236.8	6 x 3 1/2	15.2 x 8.9	12

ALUMINUM SCOOPS

Die-cast aluminum, highly polished inside and outside, and a grooved finish handle with finger grip to prevent slipping.

STANDARD

ITEM	CAPACITY		BOWL SIZE		PACK
	OZ	ML	IN	CM	
100012	5	147.9	4 3/4 x 2 3/8	12.1 x 6	12
100016	12	354.8	5 7/8 x 3 1/8	14.9 x 13	12
100020	24	709.7	7 1/4 x 4	18.4 x 10.2	12
100023	38.8	1147.3	8 3/4 x 4 3/4	22.2 x 12.1	12
100026	58	1715.1	10 5/16 x 5 1/4	26.2 x 13.3	12
100030	85	2513.5	12 x 6 1/4	30.5 x 15.9	12

ECONOMY

ITEM	CAPACITY		BOWL SIZE		PACK
	OZ	ML	IN	CM	
 100012E	5	147.9	4 1/2 x 2 1/4	11.4 x 5.7	12
100016E	12	354.8	5 3/4 x 3	14.6 x 7.6	12
100020E	24	709.8	7 1/4 x 4	18.4 x 10.2	12
100023E	38	1123.8	8 x 4 1/2	20.3 x 11.4	12
100026E	58	1715.1	10 x 5	25.4 x 12.7	12
100030E	85	2513.7	11 x 6	27.9 x 15.2	12



1000 Series



1000E Series

 Economy line offerings are identified by our green e-line icon and matching color-coded chart items.



ALUMINUM SCOOP FLAT BOTTOM

Made of one-piece cast aluminum with a tumbled finish.

ITEM	CAPACITY		BOWL SIZE		PACK
	OZ	ML	IN	CM	
B147	7	207	5 1/2 x 3 1/4	14 x 8.3	12
B175	16	473.1	7 x 4 1/4	17.8 x 10.8	12
B172	44	1301.5	8 1/2 x 5 1/2	21.6 x 14	12

STAINLESS STEEL FLOUR SIFTER

18/8 stainless steel with a highly polished body, handle, and 16 mesh (squares per inch) screen. Beater is chrome-plated with wire reinforcement on the bottom. Individually boxed.

ITEM	CAPACITY				PACK
	LB	KG	IN	CM	
1250	1 1/2	3.3	4 1/4 x 5 5/8	10.8 x 14.3	1
1260	3	6.6	6 x 6 1/2	15.2 x 16.5	1



1260



1250



PD10

PDR10

Rack and dispenser sold separately.

ALUMINUM PANCAKE DISPENSER

Easy portion control dispensing of batter from 1/2 oz. to 8 oz.

ITEM	DIAMETER		HEIGHT		O/A HEIGHT		PACK
	IN	CM	IN	CM	IN	CM	
 PD10	6 1/2	16.5	7 1/2	19.1	13	33	1
PDR10	5 3/4	14.6	6	15.2			1

 Economy line offerings are identified by our green e-line icon and matching color-coded chart items.



ALUMINUM PIE PLATES

Trust these rust-resistant, 1" deep pie plates to have fast, even heating to serve you well from baking to display.

ITEM	INSIDE TOP		BOTTOM		DEPTH		PACK
	IN	CM	IN	CM	IN	CM	
A1109B	8 15/16	22.7	6 1/2	16.5	1	2.5	200
A1110B	9 9/16	24.3	7 1/4	18.4	1	2.5	200

PIE MARKER

Set the cut markings for any diameter and choose from seven serving sizes for the perfect presentation. Reliable, consistent sizing eliminates waste and increases profitability. The cast aluminum pie marker has a polished finish.

ITEM	NO. OF CUTS	PACK
8405	5	12
8406	6	12
8407	7	12
8408	8	12
8409	9	12
8410	10	12
8412	12	12

STAINLESS STEEL PIE CUTTER

Make precise one-step cuts with this well-balanced pie cutter. Repeatable portions mean better presentation and eliminate waste. Three portion sizes available.

ITEM	CUT	PACK
856	6	1
857	7	1
858	8	1

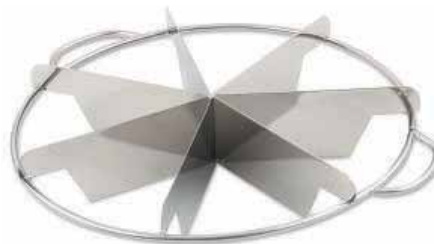



LAYER CAKE PANS

Aluminized steel glazed with rolled rims and rounded edges for easier release, cleaning, and stacking. Layer cake pans also available unglazed upon request.



ITEM	TOP DIAMETER		DEPTH		PACK
	IN	CM	IN	CM	
P6015	6	15.2	1 1/2	3.8	12
P7020	7	17.8	2	5.1	12
P8015	8	20.3	1 1/2	3.8	12
P9015	9	22.9	1 1/2	3.8	12
P8020	8	20.3	2	5.1	12
P9020	9	22.9	2	5.1	12
P1010	10	25.4	1	2.5	12
P1020	10	25.4	2	5.1	12
P1220	12	30.5	2	5.1	12



CAKE STAND

This attractive stainless steel display stand will enhance desserts' visibility and desirability.

ITEM	O/A DIAMETER		INSIDE DIAMETER		BASE		HEIGHT		PACK
	IN	CM	IN	CM	IN	CM	IN	CM	
0136	13	33	12	30.5	6 3/8	16.2	7 1/8	18.1	2
CK20512	Plastic cake cover available. Please see Plasticware chapter, page 68.								

SPRING FORM CAKE PANS

High polish tin with removable bottoms for easy cake removal. Choose from four different diameters.

ITEM	DIAMETER		HEIGHT		PACK
	IN	CM	IN	CM	
08	8	20.3	2 1/2	6.4	1
09	9	22.9	2 1/2	6.4	1
010CP	10 3/8	26.4	2 1/2	6.4	1
011	11 1/4	28.6	2 1/2	6.4	1



Nylon Pastry Bags

Pastry chefs love our nylon pastry bags. Some say it's the feel. Some say it's the pliability. Others say it simply allows them the freedom to turn a creative idea into a delicious dessert.



NYLON PASTRY BAGS

Our most affordable, reusable pastry bag is made of super pliable nylon for exceptional control and feel. This is the best value for light-duty applications and detailing. Simply boil for easy cleaning.

ITEM	IN	CM	PACK
NPB1	7 x 11	17.8 x 27.9	12
NPB2	8 x 12	20.3 x 30.5	12
NPB3	9 x 13	22.9 x 33	12
NPB4	9 x 15	22.9 x 38.1	12
NPB5	10 x 17	25.4 x 43.2	12
NPB6	11 x 18	27.9 x 45.7	12
NPB7	12 x 19	30.5 x 48.3	12
NPB8	13 5/8 x 21	34.6 x 53.3	12
NPB9	14 3/4 x 23	37.5 x 58.4	12
NPB10	15 1/2 x 24	39.4 x 61	12

DECORATING SET

Decorate pastries and cakes with No. 1 pastry bag, one coupling, six assorted pattern tubes and display box.

ITEM	DESCRIPTION	PACK
1223	Set	1
1223C	Coupling	12



DECORATING COMB

Made of strong aluminum, this three-sided tool gives pastry designers the most even shape control.

ITEM	LENGTH		PACK
	IN	CM	
1446	4	10.2	12



SPECIALTY ICE CREAM/FOOD DISHERS

Make a fabulous and rare culinary presentation with these plastic handled dishers, in three sizes and shapes, individually boxed.

ITEM	SHAPE	SIZE	CAPACITY		PACK
			OZ	ML	
HDU12225	Heart	25	1 3/8	40	1
SDU12220	Square	20	1 5/8	50	1
SDU12230	Square	30	1 2/15	33.3	1

DECORATING TUBE SETS

Enjoy a wide range of creative possibilities with this collection of decorating tubes, including standard coupling. Stores in a hinged box.



883

ITEM	NO. OF TUBES	MATERIAL	PACK
882	Set of 26	Stainless Steel	6
883	Set of 52	Stainless Steel	6



PASTRY TUBES

The right tool for the right job, these stainless steel pastry tubes available in ten sizes for each design.

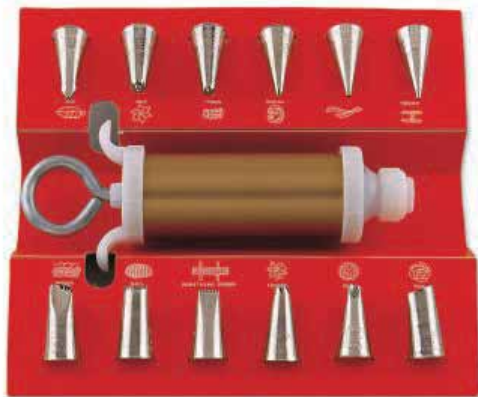

SYRINGE SET

For precise detail work, a syringe offers the best control. The decorating set has twelve assorted stainless steel tubes. Heavy plated syringes and coupling.

ITEM	DESCRIPTION	PACK
556	Set	1
557	Syringe Only	1

ITEM	TIP STYLE	LENGTH		PACK
		IN	CM	
5020T	Plain	2	5.1	12
5021T	Plain	2	5.1	12
5022T	Plain	2	5.1	12
5023T	Plain	2	5.1	12
5024T	Plain	2	5.1	12
5025T	Plain	2	5.1	12
5026T	Plain	2	5.1	12
5027T	Plain	2	5.1	12
5028T	Plain	2	5.1	12
5029T	Plain	2	5.1	12
5040T	Star	2	5.1	12
5041T	Star	2	5.1	12
5042T	Star	2	5.1	12
5043T	Star	2	5.1	12
5044T	Star	2	5.1	12
5045T	Star	2	5.1	12
5046T	Star	2	5.1	12
5047T	Star	2	5.1	12
5048T	Star	2	5.1	12
5049T	Star	2	5.1	12



PASTRY BRUSHES

Sterilized bristles with a rubber ferrule. Choose from 5 different widths.

ITEM	BRUSH WIDTH		PACK
	IN	CM	
3915W	1	2.5	12
3916W	1 1/2	3.8	12
3917W	2	5.1	12
3919W	3	7.6	12
3920W	4	10.2	12
3921W	2	5.1	12
3922W	4	10.2	12
3925W	1	2.5	12



PLASTIC PASTRY BRUSHES

Reduce contamination with our sterilized bristles and all-plastic, curved, and footed handle that keep bristles raised off work table surfaces. Available in two widths.

ITEM	BRUSH WIDTH		PACK
	IN	CM	
4917W	2	5.1	12
4919W	3	7.6	12



ROUND PASTRY BRUSH

Traditional pastry brush has sterilized bristles and a stainless steel band.

ITEM	BARREL DIAMETER		O/A LENGTH		PACK
	IN	CM	IN	CM	
AL9125X	1	2.5	10 1/2	26.7	12



ROLLER DOCKER

Docker has a 5" (12.7 cm) nylon roller and a cast aluminum handle.

ITEM	O/A LENGTH		
	IN	CM	PACK
RD582	8	20.3	1



PASTRY BRUSHES

Choose from six widths of brushes, with sterilized bristles and a stainless steel band.

ITEM	BRUSH WIDTH		PACK
	IN	CM	
AL9115W	1	2.5	12
AL9116W	1 1/2	3.8	12
AL9117W	2	5.1	12
AL9118W	2 1/2	6.4	12
AL9119W	3	7.6	12
AL9120W	3 1/2	8.9	12

Rolling Pins

Dedication to detail and excellence is evident in our traditional wood rolling pins. The rolling pins are crafted from high quality wood, ensuring years of use even in busy commercial kitchens. Our classically designed aluminum rolling pins round out the collection.



ROLLING PINS

The revolving barrel, no-bearing, has a 2 3/4" (7 cm) economy hardwood barrel.

	BARREL LENGTH		HANDLE LENGTH		PACK
	IN	CM	IN	CM	
 313RTWN	13	33	4	10.1	6
315RTWN	15	38.1	4	10.1	6
318RTWN	18	45.7	4	10.1	6

ROLLING PINS

The revolving barrel, nylon bearing rolling pin has a 2 3/4" (7 cm) hardwood barrel.

ITEM	BARREL LENGTH		HANDLE LENGTH		PACK
	IN	CM	IN	CM	
310R	9 3/4	24.8	3 1/2	8.9	12
313R	13	33	3 1/2	8.9	12
315R	15	38.1	3 3/4	9.5	12
318R	18	45.7	3 3/4	9.5	12

ROLLING PINS

The revolving barrel, stainless steel ball bearing rolling pin has a 2 3/4" (7 cm) hardwood barrel.

ITEM	BARREL LENGTH		HANDLE LENGTH		PACK
	IN	CM	IN	CM	
1310	10	25.4	3 1/2	8.9	12
1313	13	33	3 1/2	8.9	12
1315	15	38.1	3 3/4	9.5	12
1318	18	45.7	3 3/4	9.5	12

313RTWN

318RTWN



ALUMINUM ROLLING PIN

A classic design updated with aluminum for an easy-to-clean rolling pin. Ball bearing roller and a cast aluminum barrel measures 3 1/2" (8.9 cm).

ITEM	BARREL LENGTH		O/A LENGTH		PACK
	IN	CM	IN	CM	
844713	13	33	21 1/2	54.6	1
844715	15	38.1	23 1/4	59.1	1
844718	18	45.7	26 1/2	67.3	1

PIE PIN

This hardwood pin is perfect for rolling dough for pie crust. 1 5/16" (3.3 cm) diameter barrel.

ITEM	BARREL LENGTH		PACK
	IN	CM	
PP21	21 5/8	54.9	12



 Economy line offerings are identified by our green e-line icon and matching color-coded chart items.

MULTIPLE WHEEL DOUGH CUTTERS

Nickel-plated steel frame for perfect parallel cutting. 4 3/4" distance between wheels when expanded. Overall expanded length is 19 3/4", 24 1/2" and 29 1/4" respectively for items 2225, 2226, and 2227DC.



ITEM	WHEEL DESCRIPTION	NO. OF WHEELS	DIAMETER OF WHEELS		
			IN	CM	PACK
2225	Nickel	Five	2 1/8	5.4	1
2227DC	Nickel	Seven	2 1/8	5.4	1
2226	Stainless Steel	Six	2 1/8	5.4	1

ROUND COOKIE CUTTER SETS

Multiple sizes offer better control over portions and costs. Sturdy wire rim provides easier handling. Sets are packaged in individual can.

ITEM	DESCRIPTION	NO. OF CUTTERS	MATERIAL	PACK
46CC	Scalloped	8	S/S	1
45	Plain	16	Tinned	1



COOKIE CUTTERS

Solid construction and design for heavy commercial use.

ITEM	DIAMETER		MATERIAL	PACK
	IN	CM		
947CC	3	7.6	Steel	12





ALUMINUM MUFFIN/CUP CAKE PANS

Heavy-duty construction with cups permanently seamed in the frame.

ITEM	CUPS	TOP INSIDE DIAMETER		BOTTOM DIAMETER		FRAME		PACK
		IN	CM	IN	CM	IN	CM	
1612A	12	2 3/4	7	2	5.1	10 3/4 x 14 1/8 x 1	27.3 x 35.9 x 2.5	24
1624A	24	2 3/4	7	2	5.1	20 5/8 x 14 1/8 x 1	52.4 x 35.9 x 2.5	12



MUFFIN PANS

Aluminized steel, glazed pans are durable and easy to clean.

ITEM	CUPS	TOP INSIDE DIAMETER		BOTTOM DIAMETER		DEPTH ON SLANT		PACK
		IN	CM	IN	CM	IN	CM	
143	12	2 3/4	7	2 1/16	5.2	1 3/8	3.5	12
2043	24	2 3/4	7	2 1/16	5.2	1 3/8	3.5	12



BREAD PANS

Aluminized steel glazed with rounded edges for easier release and cleaning.

ITEM	TOP INSIDE		INSIDE DEPTH		LOAF CAPACITY		
	IN	CM	IN	CM	OZ	ML	PACK
B4106	8 x 4	20.3 x 10.3	2 1/2	6.4	12	355	12
B4107	8 1/2 x 4 1/2	21.6 x 11.4	2 3/4	7	16	473	12
B4144	9 x 4 1/2	22.9 x 11.4	2 3/4	7	16	473	12



DISPLAY PANS

Pans are 16 gauge aluminum with textured, gold anodized finish.

ITEM	IN	CM	PACK
B5055	9 x 26 x 1	22.9 x 66 x 2.5	12
B5070	12 x 18 x 1	30.5 x 45.7 x 2.5	12
B5090	18 x 26 x 1	45.7 x 66 x 2.5	12



MINI LOAF PAN

Aluminized steel glazed for easy release and cleaning. Reinforced rim adds lasting strength. Molds arranged to yield 12 loaves per pan.

ITEM	TOP INSIDE		BOTTOM OUTSIDE		DEPTH		O/A SIZE		LOAF CAPACITY		
	IN	CM	IN	CM	IN	CM	IN	CM	OZ	ML	PACK
B6903	3 7/8 x 2 1/2	9.8 x 6.4	3 1/2 x 2 1/8	8.9 x 5.4	1 1/4	3.2	9 7/8 x 19 1/2	25.1 x 49.5	5	148	12

*Please see our Professional Cookware chapter (pg. 16) for a wide selection of Eagleware® Bun & Biscuit pans to meet your additional baking needs.



PULLMAN PANS

Aluminized steel glazed pan.

ITEM	TOP INSIDE		INSIDE DEPTH		LOAF CAPACITY		
	IN	CM	IN	CM	OZ	ML	PACK
B2134P	13 x 4	33 x 10.2	4	10.2	24	710	12
B2164P	16 x 4	40.6 x 10.2	4	10.2	32	946	12

DONUT SCREEN

Made of nickel-plated steel wire. For cooling and decorating donuts.



ITEM	IN	CM	PACK
DS1725	17 x 25	43.2 x 63.5	20



WIRE RIB GRATE

Metal grate is great for cooling cakes, cookies, and breads.

ITEM	IN	CM	PACK
WRG1525	15 x 25	38.1 x 63.5	20



BAGUETTE SCREENS

Screens are French perforated, 16 gauge glazed aluminum.

ITEM	MOLDS	IN	CM	PACK
B5015	5	26 x 3 x 1	66 x 7.6 x 2.5	12
B5017	4	26 x 3 7/8 x 1	66 x 6.4 x 2.5	12
B5019	6	26 x 2 7/16 x 1	66 x 6.2 x 2.5	12



BAR SUPPLIES

Corkscrews
50 - 51

Can Openers
52

Pourers
53

Ice Picks
55

Bar Utensils
54 - 56

Glass Brushes
58

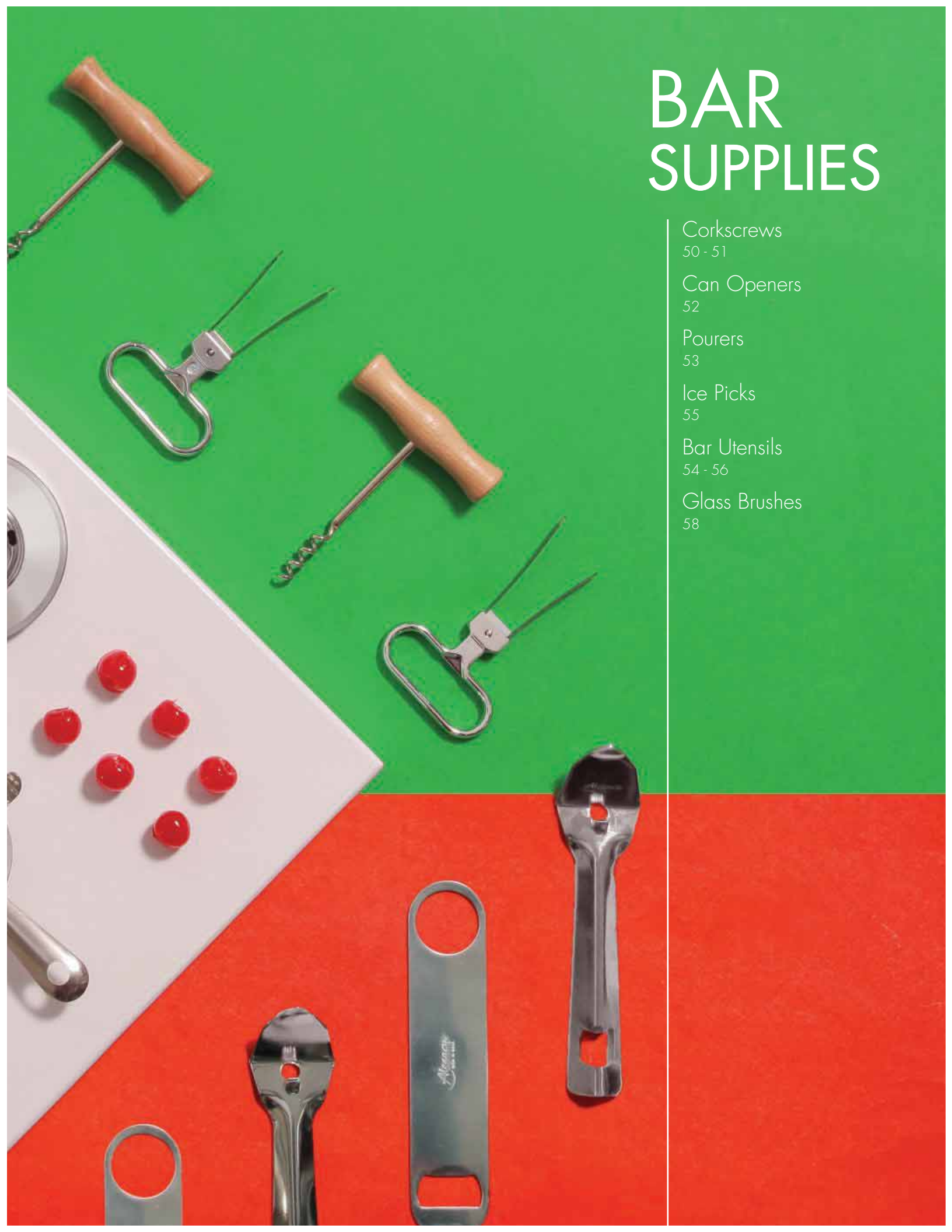

Corkscrews, Cap Lifters, & Cork Removers

Professional presentation and precision epitomize Alegacy's selection of corkscrews, cap lifters, and cork removers made from the highest quality materials to ensure years of dependable use.



"Rapid" Automatic Cork Puller & Replacement Parts

Simple and easy to operate, the "Rapid" automatic cork puller greatly reduces the time and effort required to extract corks. Its Swiss-made precision mechanism assures years of trouble-free service with professional results. Mounts on table top with attached C-clamp. A complete selection of replacement parts is available.

"RAPID" AUTOMATIC CORK PULLER

ITEM	LENGTH		PACK
	IN	CM	
1144	11	27.9	1

"RAPID" PARTS LIST

ITEM	DESCRIPTION	ITEM	DESCRIPTION
1144-17	Yoke	1144-25	Screw for Handle
1144-18	Cap Screw	1144-26	Screw for 1144-27
1144-19	Base Plate	1144-27	Fastening Screw
1144-20	Handle Screw	1144-28	Yoke Bolt
1144-21	Wood Handle	1144-29	Cross Screw for Handle
1144-22	Cartridge	1144-30	Arm
1144-22a	Feed Screw	1144-31	Worm Only
1144-23	Rubber Bumper	1144-32	Fastening Handle
1144-24	Bronze w/ Twin Rods	1144-35	Coupling Screw for 1144-22a





SUPER-HEAVY PROFESSIONAL CORKSCREW & CAP LIFTER

Black plastic over stainless steel with a hardened steel worm, it has a geared level and is individually boxed.



ITEM	LENGTH			PACK
	IN	CM		
88	8 1/2	21.6		1



"WEDGE-TYPE" CORK REMOVER

Chrome-plated, cork puller with a cap lifter built into the handle. Includes a plastic sheath.

ITEM	LENGTH			PACK
	IN	CM		
4134	5	12.7		12



PROFESSIONAL CORKSCREW & CAP LIFTER

This European quality die-cast, chrome-plated corkscrew with a geared lever, easily extracts any size cork.



CORKSCREW

This nickel-plated hardened and tempered steel wire corkscrew has a lacquered, hardwood handle with a cap lifter attachment.

ITEM	LENGTH			PACK
	IN	CM		
4136	5 1/2	14		12



CORKSCREW

Made of hardened, tempered steel wire. Boasts a lacquered, hardwood handle.

ITEM	LENGTH			PACK
	IN	CM		
4137	4 5/8	11.7		12

STANDARD WAITER'S CORKSCREW & CAP LIFTER

Nickel-plated combination corkscrew, cap lifter, and wire/band cutter.



ITEM	STYLE	LENGTH			PACK
		IN	CM		
1147K	Knife Blade	4 3/8	11.1		12



PROFESSIONAL WAITER'S CORKSCREW & CAP LIFTER

Black plastic over stainless steel with a hardened steel worm, cap lifter, and straight blade.

ITEM	STYLE	LENGTH			PACK
		IN	CM		
1148K	Knife Blade	4 3/8	11.1		12



ALEGACY GIANT OPENER

Heavy gauge bright nickel-plated, stamped steel that opens both cans and bottles.

ITEM	LENGTH		
	IN	CM	PACK
AL550	6 3/4	17.1	12



C801

CAN TAPPER & BOTTLE OPENER

Opener is nickel-plated. Standard can punch is used for small to medium sized cans, as well as bottle caps.

ITEM	LENGTH		
	IN	CM	PACK
C801	4	10.2	100
C801DZ	4	10.2	12



ALEGACY "HANDY-OPENER"

Nickel-plated, heavy stamped steel for opening cans and bottles.

ITEM	LENGTH		
	IN	CM	PACK
CP290	5 1/4	13.3	12



CAP REMOVER

Avoid corrosion with our high quality stainless steel cap remover.

ITEM	DESCRIPTION	PACK
11975	Stainless Steel	1



BOTTLE OPENER

Extra-thick stainless steel. Convenient, compact size. Use for professional bartending.

ITEM	LENGTH		
	IN	CM	PACK
AL552	7	17.8	12



WALL CAP REMOVER

Made of cast-metal.

ITEM	DESCRIPTION	PACK
1199	Cadmium-Plated	1



PINT POURERS - BOTTLE & COLOR TOP ONLY

For smaller volumes of liquid, or secondary storage, these pint-size bottles have pourers interchangeable with their quart-size counterparts.

ITEM	CAPACITY		CORK COLOR	PACK
	OZ	ML		
PP1BR	16	473.3	Brown	12
PP2GR	16	473.3	Green	12
PP3RD	16	473.3	Red	12
PP4OR	16	473.3	Orange	12
PP5WH	16	473.3	White	12
PP6YL	16	473.3	Yellow	12

CAP CATCHER

18/8 stainless steel cap catcher will last longer and work better than other less corrosion-resistant materials in the abusive wet and humid environment of the back bar.

ITEM	IN	CM	PACK
CC10	3 1/4 x 5 1/2 x 13	8.25 x 14 x 33	1



QUART POURERS WITH CAP

Our high-density, polyethylene pourers, with free flow spout and protective cap, come in a variety of colors for easy content identification.

ITEM	CAPACITY		CAP COLOR	PACK
	OZ	ML		
PQ1BR	32	946.6	Brown	12
PQ2GR	32	946.6	Green	12
PQ3RD	32	946.6	Red	12
PQ4OR	32	946.6	Orange	12
PQ5WH	32	946.6	White	12
PQ6YL	32	946.6	Yellow	12



COCKTAIL PARASOLS

Parasols have a wooden stem and are 3" (7.6 cm) in diameter when open. Assorted colors.

ITEM	LENGTH		PACK
	IN	CM	
4600	4 1/16	10.3	144



TOOTHPICK FRILLS

Round, wooden toothpicks with assorted colored cellophane frill end for sandwiches and/or cocktails. Packed 1,000 per tray box, 10,000 per shipping case. Sold in case lot only.

ITEM	LENGTH		PACK
	IN	CM	
FC23	2 3/4	7	1 cs
FC25	4 1/4	10.8	1 cs



WOOD MUDDLER

Muddler is turned, highly polished, alcohol proof, and made of hardwood.

ITEM	LENGTH		PACK
	IN	CM	
115M	8	20.3	24



BAR DRAINER/MAT

Mats are made of brown, soft rubber with a well at each end (for the BD273BR) or full size with no well (for BD1218BR).

ITEM	IN	CM	PACK
BD273BR	3 1/4 x 27	8.3 x 68.6	12



GLASS RIMMER

Easy salting of drinks and general bar use.

ITEM	DESCRIPTION	DIAMETER		PACK
		IN	CM	
GR30	Glass Rimmer	6 1/4	15.9	1
GR30S	Replacement Sponge	5 5/8	14.3	12

 Economy line offerings are identified by our green e-line icon and matching color-coded chart items.



COCKTAIL STRAINER

Stainless steel body and spring.

ITEM	DESCRIPTION	LENGTH		PACK
		IN	CM	
1287	4 Ears	6	15.2	12



JULEP STRAINER

Stainless steel, two-piece construction with the handle welded to the bowl.

ITEM	BOWL DIAMETER		LENGTH		PACK
	IN	CM	IN	CM	
292	3 1/8	8	6 1/4	16	12



ICE PICK

Carbon steel blade, 4 1/2" (11.4 cm) long with a hardwood handle.

ITEM	LENGTH		PACK
	IN	CM	
71P	7 1/2	19.1	12



SIX POINT ICE CHIPPER

Heavy-duty, six carbon steel points with a hardwood handle.

ITEM	LENGTH		PACK
	IN	CM	
60IC	9	22.9	12



LEMON/LIME SQUEEZER

Made of heavy, 18/8 stainless steel.

ITEM	DESCRIPTION	LENGTH		PACK
		IN	CM	
453	Closed Jaw	6 5/8	16.8	12



CITRUS SQUEEZER

Available in three colors for limes, lemons, and oranges. Carded.

ITEM	DESCRIPTION	COLOR	PACK
 CS25	Citrus Squeezer - Lime	Green	1
CS30	Citrus Squeezer - Lemon	Yellow	1
CS35	Citrus Squeezer - Orange	Orange	1

 Economy line offerings are identified by our green e-line icon and matching color-coded chart items.



STAINLESS STEEL DOUBLE JIGGERS

Polished on the outside with a satin finish inside.

CAPACITY

ITEM	OZ	ML	PACK
1290	1/2 - 1	14.8 - 29.6	12
1291	3/4 - 1 1/2	22.2 - 44.4	12
1292	1 - 1 1/2	29.6 - 44.4	12
1293	1 - 2	29.6 - 59.1	12
1294	3/4 - 1 1/4	22.2 - 36.9	12
1295	1 - 1 1/4	29.6 - 36.9	12

STAINLESS STEEL BAR SPOON

One-piece handle and bowl construction. Handle is twisted for ease of stirring.



LENGTH

ITEM	DESCRIPTION	IN	CM	PACK
1511B	w/ Red Ball	10 1/4	26	12



CS53812



CS277WC



CS377



CS377WC

COCKTAIL SHAKERS

Stainless steel with a polished outside and a satin-finish inside, shaped to fit a shaker glass.

CAPACITY

HEIGHT

TOP DIAMETER

ITEM	OZ	ML	IN	CM	IN	CM	PACK
CS377	30	887.1	7	17.8	3 5/8	9.2	12
CS53812	15	443.6	4 1/2	11.4	3 3/8	8.6	12
SHAKERS WITH COVER & STRAINER							
CS277WC	16	473.3	7 3/4	19.7	3 7/8	9.8	12
CS377WC	30	887.1	10	25.4	3 5/8	9.2	12



WINE BUCKET

Present wine and champagne in this attractive and practical wine bucket.

ITEM	DESCRIPTION	HEIGHT		DIAMETER		PACK
		IN	CM	IN	CM	
6950	Bucket and Stand	32	81.2	-	-	1
69501	18/8 S/S Bucket	9 1/2	24.1	8 3/4	22.2	6
69502	Stand Only	29 1/2	74.9	-	-	1



WINE BUCKET

A wide selection of wine buckets, from plain to hammered patterns to mirror finishes with elegant details, complement any dining occasion.

ITEM	DESCRIPTION	HEIGHT		DIAMETER		PACK
		IN	CM	IN	CM	
79501	Hammered Wine Bucket	8 1/2	21.6	7 1/2	19.1	1
79502	Wine Bucket Stand	24	61	-	-	1
89501	Wine Bucket	8 3/8	21.3	8 3/8	21.3	1
IB22	Ice Bucket	5 7/8	14.9	6 5/16	16	1



TOWEL HOLDER

Nickel-plated spring steel with a screw eye for fastening to the bar.

ITEM	LENGTH		
	IN	CM	PACK
286	3 1/2	8.9	12

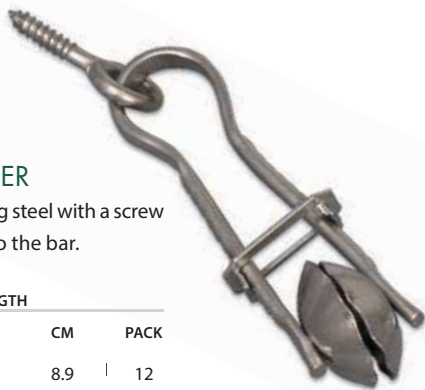

ARCTIC BAR CLOTH

Soft and absorbent, cloth is made of natural yarn with a honeycomb weave.

ITEM	IN	CM	PACK
1943	18 x 20	45.7 x 50.8	12



MALTED MILK CUP

Graduated cup is stainless steel with a polished outside and a satin-finish inside. Reinforced bottom and fits all standard machines.

ITEM	CAPACITY		HEIGHT		TOP DIAMETER		PACK
	OZ	ML	IN	CM	IN	CM	
MC388	30	887.1	6 7/8	17.5	4	10.2	12



FROTHING PITCHER

Stainless construction with heat-resistant handle design. Molded spout makes for easy pouring into any espresso based drink.

ITEM	CAPACITY		HEIGHT		PACK
	OZ	ML	IN	CM	
FC150	5	150	2 1/4	5.7	1
FC350	12	350	3 5/8	9.2	1
FC600	20	600	4 3/8	11.1	1
FC1000	33	1000	4 3/4	12.1	1
FC2000	67	2000	6 7/8	17.5	1



REFILL GLASS BRUSH

Black, nylon brush with a 7" (17.8 cm) brush head.

ITEM	LENGTH			PACK
	IN	CM		
6141N	8 1/2	21.6		10



DOUBLE GLASS BRUSH

Brush has a suction base with black, nylon brushes.

ITEM	LENGTH			PACK
	IN	CM		
6131N	8 1/2	21.6		1



TRIPLE GLASS BRUSH

Brush has a suction base with black, nylon brushes suitable for cleaning many types of glassware.

ITEM	LENGTH			PACK
	IN	CM		
6121N	8 1/2	21.6		1

ITEM	LENGTH			PACK
	IN	CM		
e™ 6121NE	10	25.4		1
6121NE1	7 1/2	19.1		1



OVERFLOW PIPES

PVC plastic set in rubber bushing is noncorroding. Pipe allows for proper water depth in sink. Fits both 1" (2.5 cm) and 1 1/2" (4 cm) drains.

ITEM	HEIGHT			PACK
	IN	CM		
AD91	(For OP90)			12
OP75	7 1/8	18.1		12
OP80*	8 3/8	21.3		12
OP90	7 3/4	19.7		12

*For shallow drain



BAR CADDY - CONDIMENT TRAY

Made of white plastic, tray is seamless, odorless, and noiseless. It has four compartments, each 4 x 4 x 2 3/4" (10.2 x 10.2 x 7 cm).

ITEM	IN	CM	PACK
B35	5 x 18 x 2 3/4	12.7 x 45.7 x 7	1



BAR CADDY

Three sizes including one pint plastic inserts. Available in four, five or six compartment configurations. Replacement inserts are also available.

ITEM	PINT	IN	CM	PACK
79300	4	11 7/8 x 5 1/2 x 3 1/2	30.2 x 14 x 8.9	1
79302	5	14 3/4 x 5 1/2 x 3 1/2	37.5 x 14 x 8.9	1
79303	6	17 3/4 x 5 1/2 x 3 1/2	45.1 x 14 x 8.9	1
79305	1	5 3/4 x 3 x 2 7/8	14.6 x 7.6 x 7.3	12

e™ Economy line offerings are identified by our green e-line icon and matching color-coded chart items.



PLASTIC FUNNELS

One piece, seamless.

ITEM	TOP DIAMETER		CAPACITY		
	IN	CM	OZ	ML	PACK
368	4 1/8	10.5	8	236.6	12
369	5 3/16	13.2	16	473.1	12
370	6 3/16	15.7	32	946.2	12



SPEED RAILS

Single and double speed rails made of AISI 304 quality stainless steel with a #4 mill satin finish. Offers a high quality spec to withstand the harshness of the back bar environment.

ITEM	DESCRIPTION	LENGTH		
		IN	CM	PACK
SR22	Single	22	55.9	1
SR32	Single	32	81.3	1
SR42	Single	42	106.7	1
SR22D	Double	22	55.9	1
SR32D	Double	32	81.3	1
SR42D	Double	42	106.7	1

SPEED RAIL STRAP

Strap accessory allows you to hang speed rails on bar counter.

ITEM	LENGTH		
	IN	CM	PACK
SRS1	9 1/2	24.1	12

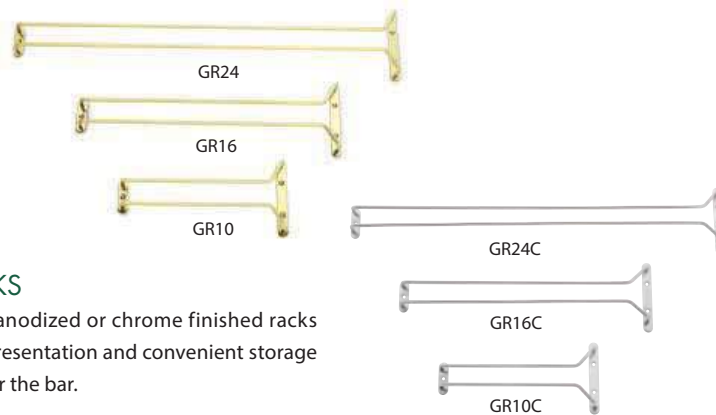

GLASS RACKS

Attractive gold anodized or chrome finished racks make for clear presentation and convenient storage of glassware over the bar.

ITEM	FINISH	LENGTH		
		IN	CM	PACK
GR10	Gold	10	25.4	12
GR16	Gold	16	40.6	12
GR24	Gold	24	61	12
GR10C	Chrome	10	25.4	12
GR16C	Chrome	16	40.6	12
GR24C	Chrome	24	61	12

FLATWARE CYLINDER

Made of white plastic.

ITEM	HEIGHT		DIAMETER		
	IN	CM	IN	CM	PACK
80104	5 1/4	13.3	4 1/4	10.8	36



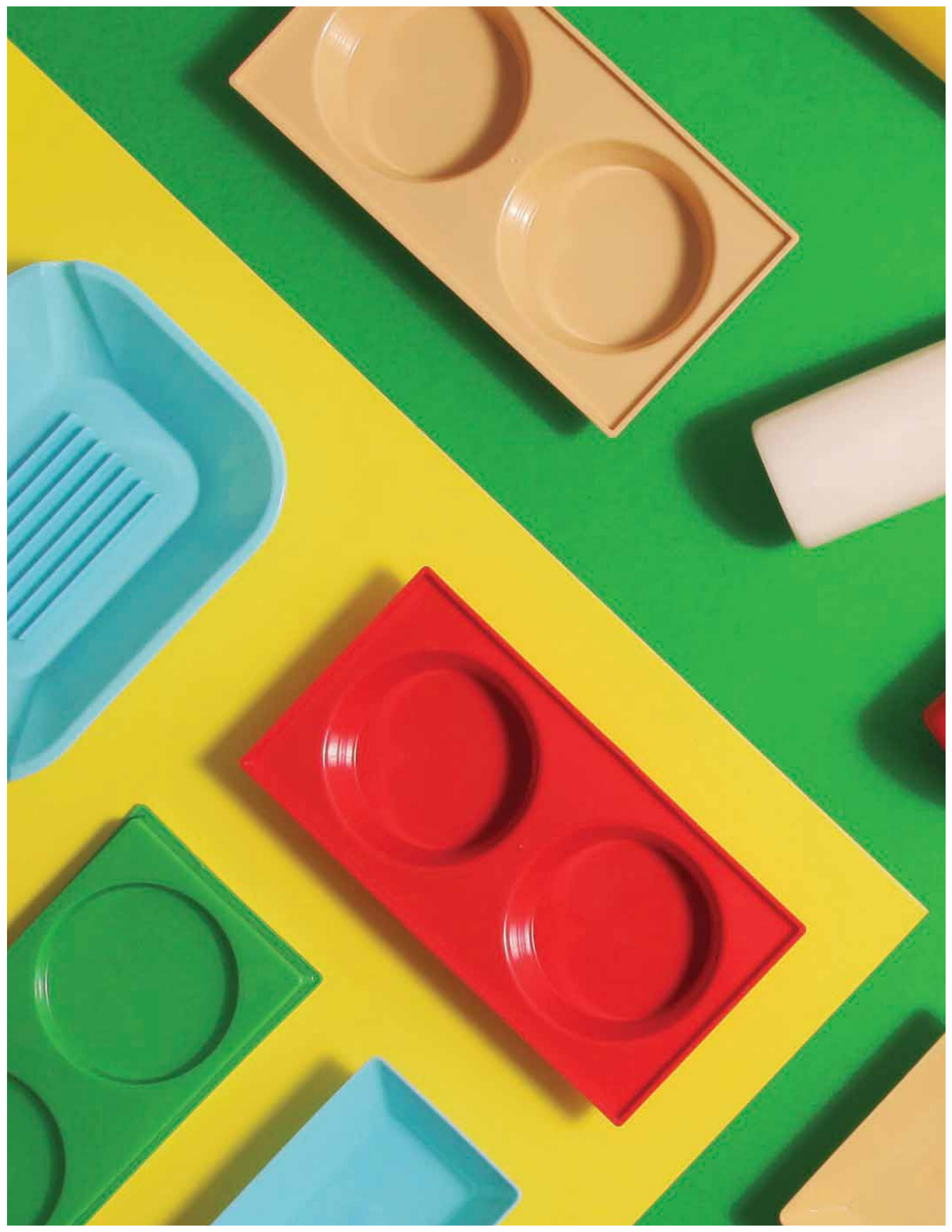



PLASTICWARE

Squeeze Dispensers

62

Food Baskets

63 - 64

Trays

63, 68

Tote Boxes

65

All-Purpose Prep Trays

66 - 67

Pitchers

69

Food Pans & Storage Containers

70 - 71

Tumblers

72

Serving Utensils

73

Squeeze Dispensers

Burgers anyone? These high quality, soft and molded, polyethylene squeeze dispensers are available in a variety of colors, sizes, and packs. Plus, the flexible, softer material allows for dispensing maximum amount out of the bottles, creating food savings for you. Firmly attached no-drip spout caps won't pop off, avoiding messy table and counter messes.



LARGE SQUEEZE BOTTLES

These larger polyethylene dispensers are flexible and durable, with a no-drip tip design. The larger size allows heavier use with less refilling. Quality crafted in the U.S.A. at Alegacy's manufacturing facility.

ITEM	DESCRIPTION	CAPACITY		COLOR	PACK
		OZ	ML		
2401	Ketchup	24	710	Red	12
2402	Mustard	24	710	Yellow	12
2403	Dressing	24	710	Clear	12
3201	Ketchup	32	946	Red	12
3202	Mustard	32	946	Yellow	12
3203	Dressing	32	946	Clear	12



SQUEEZE BOTTLES

These polyethylene squeeze dispensers are flexible and durable, with a no-drip tip design. They're quality crafted in the U.S.A. at Alegacy's manufacturing facility. Replacement tops available and listed in the price list.

ITEM	DESCRIPTION	CAPACITY		COLOR	PACK
		OZ	ML		
1100	Ketchup	8	236	Red	72
1101	Mustard	8	236	Yellow	72
1102	Dressing	8	236	Clear	72
2101	Ketchup	12	355	Red	72
2102	Mustard	12	355	Yellow	72
2103	Dressing	12	355	Clear	72

DOZEN PACK

1100-12	Ketchup	8	236	Red	12
1101-12	Mustard	8	236	Yellow	12
1102-12	Dressing	8	236	Clear	12
2101-12	Ketchup	12	355	Red	12
2102-12	Mustard	12	355	Yellow	12
2103-12	Dressing	12	355	Clear	12

WIDE MOUTH SQUEEZE BOTTLES

Made of the same high quality polyethylene as our other squeeze dispensers, the wide mouth bottles also feature a 2 1/4" opening, large enough for most any spoon. Not only can you squeeze these bottles to the last drop, now you can scrape out any remaining residue too. And they're quality crafted in the U.S.A. at Alegacy's manufacturing facility.



ITEM	DESCRIPTION	CAPACITY		COLOR	PACK
		OZ	ML		
1601W	Ketchup	16	472	Red	12
1602W	Mustard	16	472	Yellow	12
1603W	Dressing	16	472	Clear	12
2401W	Ketchup	24	710	Red	12
2402W	Mustard	24	710	Yellow	12
2403W	Dressing	24	710	Clear	12
3201W	Ketchup	32	946	Red	12
3202W	Mustard	32	946	Yellow	12
3203W	Dressing	32	946	Clear	12

Fast Food Baskets

Alegacy's food baskets are the perfect answer to paper waste in the fast food industry. They also reduce dish use and dishwashing time, substantially cutting costs. Food baskets are available in stiff or flexible construction and are the ideal size for hamburgers and french fries as well as appetizers. They are stackable, microwaveable, and dishwasher safe.



496 Series

OVAL FAST FOOD BASKETS

Low design and stiff construction.

ITEM	IN	CM	COLOR	PACK
496FB	10 3/4 x 7 x 1 1/2	27.3 x 17.8 x 3.8	Brown	36
496FG	10 3/4 x 7 x 1 1/2	27.3 x 17.8 x 3.8	Green	36
496FO	10 3/4 x 7 x 1 1/2	27.3 x 17.8 x 3.8	Orange	36
496FR	10 3/4 x 7 x 1 1/2	27.3 x 17.8 x 3.8	Red	36
496FT	10 3/4 x 7 x 1 1/2	27.3 x 17.8 x 3.8	Tan	36
496FW	10 3/4 x 7 x 1 1/2	27.3 x 17.8 x 3.8	White	36
496FY	10 3/4 x 7 x 1 1/2	27.3 x 17.8 x 3.8	Yellow	36

OVAL FAST FOOD BASKETS

Sloped sides and flexible construction.

ITEM	IN	CM	COLOR	PACK
499FB	9 3/8 x 2	23.8 x 5.1	Brown	36
499FG	9 3/8 x 2	23.8 x 5.1	Green	36
499FO	9 3/8 x 2	23.8 x 5.1	Orange	36
499FR	9 3/8 x 2	23.8 x 5.1	Red	36
499FT	9 3/8 x 2	23.8 x 5.1	Tan	36
499FW	9 3/8 x 2	23.8 x 5.1	White	36
499FY	9 3/8 x 2	23.8 x 5.1	Yellow	36
499FAST	9 3/8 x 2	23.8 x 5.1	Assorted	4/6



499 Series



PLASTIC SERVING TRAYS

These plastic trays are thicker than the industry standard. The injection molded polypropylene features a non-skid basketweave finish which allows for quick drying.

ITEM	IN	CM	COLOR	PACK
1014B	10 x 14	25.4 x 35.6	Brown	24
1014R	10 x 14	25.4 x 35.6	Red	24
1216B	12 x 16	30.5 x 40.6	Brown	24
1216R	12 x 16	30.5 x 40.6	Red	24
1418B	14 x 18	35.6 x 45.7	Brown	24
1418R	14 x 18	35.6 x 45.7	Red	24

Cash & Carry Collection

Our colorful fast food baskets and squeeze bottles are now attractively designed and packaged to increase point of sale purchasing.



FLAT BOTTOM OVAL FAST FOOD BASKETS

ITEM	IN	CM	COLOR	PACK	
				INNER	MASTER
AL12496FB	10 3/4 x 7 x 1 1/2	27.3 x 17.8 x 3.8	Brown	12 ea	3 pk
AL12496FG	10 3/4 x 7 x 1 1/2	27.3 x 17.8 x 3.8	Green	12 ea	3 pk
AL12496FO	10 3/4 x 7 x 1 1/2	27.3 x 17.8 x 3.8	Orange	12 ea	3 pk
AL12496FR	10 3/4 x 7 x 1 1/2	27.3 x 17.8 x 3.8	Red	12 ea	3 pk
AL12496FT	10 3/4 x 7 x 1 1/2	27.3 x 17.8 x 3.8	Tan	12 ea	3 pk
AL12496FW	10 3/4 x 7 x 1 1/2	27.3 x 17.8 x 3.8	White	12 ea	3 pk
AL12496FY	10 3/4 x 7 x 1 1/2	27.3 x 17.8 x 3.8	Yellow	12 ea	3 pk



ROUND BOTTOM OVAL FAST FOOD BASKETS

ITEM	IN	CM	COLOR	PACK	
				INNER	MASTER
AL12499FB	9 3/8 x 2	23.8 x 5.1	Brown	12 ea	3 pk
AL12499FG	9 3/8 x 2	23.8 x 5.1	Green	12 ea	3 pk
AL12499FO	9 3/8 x 2	23.8 x 5.1	Orange	12 ea	3 pk
AL12499FR	9 3/8 x 2	23.8 x 5.1	Red	12 ea	3 pk
AL12499FT	9 3/8 x 2	23.8 x 5.1	Tan	12 ea	3 pk
AL12499FW	9 3/8 x 2	23.8 x 5.1	White	12 ea	3 pk
AL12499FY	9 3/8 x 2	23.8 x 5.1	Yellow	12 ea	3 pk



SQUEEZE BOTTLES

ITEM	CAPACITY		COLOR	PACK	
	OZ	ML		INNER	MASTER
AL61100	8	236	Red	6 ea	6 pk
AL61101	8	236	Yellow	6 ea	6 pk
AL61102	8	236	Clear	6 ea	6 pk
AL62101	12	355	Red	6 ea	6 pk
AL62102	12	355	Yellow	6 ea	6 pk
AL62103	12	355	Clear	6 ea	6 pk
AL62401	24	710	Red	6 ea	6 pk
AL62402	24	710	Yellow	6 ea	6 pk
AL62403	24	710	Clear	6 ea	6 pk
AL63201	32	946	Red	6 ea	6 pk
AL63202	32	946	Yellow	6 ea	6 pk
AL63203	32	946	Clear	6 ea	6 pk

WIDE MOUTH SQUEEZE BOTTLES

ITEM	CAPACITY		COLOR	PACK	
	OZ	ML		INNER	MASTER
AL61601W	16	472	Red	6 ea	6 pk
AL61602W	16	472	Yellow	6 ea	6 pk
AL61603W	16	472	Clear	6 ea	6 pk
AL62401W	24	710	Red	6 ea	6 pk
AL62402W	24	710	Yellow	6 ea	6 pk
AL62403W	24	710	Clear	6 ea	6 pk
AL63201W	32	946	Red	6 ea	6 pk
AL63202W	32	946	Yellow	6 ea	6 pk
AL63203W	32	946	Clear	6 ea	6 pk

All items shrink-wrapped. All items sold by pack in master case quantity only.



CUTLERY BOX

Made of high-density plastic, this seamless, odorless, and noiseless cutlery box is perfect for storage of individually packaged condiments. The narrow size also lends itself to space-saving storage.



ITEM	IN	CM	STYLE	COLOR	PACK
1990	21 1/2 x 11 3/4 x 3 3/4	54.6 x 29.8 x 9	4 Compartment	Gray	12



STACKING LUG

Heavy-duty polyethylene lugs are stackable for convenient storage. The reinforced corners ensure durability while the molded design prevents suction for easy removal from nesting. The oversize rim makes handling more convenient and is designed to allow criss-cross stacking when full.

ITEM	IN	CM	COLOR	PACK
14101	26 x 16 1/4 x 8	66 x 41.3 x 20.3	Gray	6

UNDERCOUNTER DISH 'N TOTE BOX

Our dish and tote boxes have that indestructible feel necessary to get the tough work done, day after day. They are made of heavy-duty polyethylene and are narrow for tight-space storage. The handles are reinforced for heavy load support. Dishwasher safe.



ITEM	IN	CM	COLOR	PACK
1919	21 x 12 x 6	53.3 x 30.5 x 15.2	Gray	12



DISH 'N TOTE BOX

This all-purpose tote box made of heavy, high density plastic is seamless for easy cleaning, odorless, and noiseless for customer-friendly bussing. The under rim lugs allow for perfect nesting. Dishwasher safe. Sterilizes to commercial standards.

ITEM	IN	CM	COLOR	PACK
1900	21 5/8 x 16 x 5	54.9 x 40.6 x 12.7	Gray	12

Made with pride in the U.S.A.

ALL PURPOSE 1LB. BOAT/FOOD TRAY

Ideal for the preparation and processing of food in a busy kitchen. Versatility from the microwave to dishwasher saves you time, and durable plastic construction eliminates the need for paper waste. Available in 6 HACCP colors.

ITEM	COLOR	IN	CM	PACK
495FB	Blue	5 5/8 x 4 x 1 1/2	14.3 x 10.2 x 3.8	100
495FG	Green	5 5/8 x 4 x 1 1/2	14.3 x 10.2 x 3.8	100
495FR	Red	5 5/8 x 4 x 1 1/2	14.3 x 10.2 x 3.8	100
495FT	Tan	5 5/8 x 4 x 1 1/2	14.3 x 10.2 x 3.8	100
495FW	White	5 5/8 x 4 x 1 1/2	14.3 x 10.2 x 3.8	100
495FY	Yellow	5 5/8 x 4 x 1 1/2	14.3 x 10.2 x 3.8	100

D767, 940



495FR



EGG TRAY

Two compartment stackable egg tray allows for microwave cooking of eggs. Available in 6 HACCP colors. Bottom and cover sold as a complete set and also sold separately.

ITEM	COLOR	IN	CM	PACK
497FBC	Blue	10 1/4 x 5 3/8 x 2	26 x 13.6 x 5.1	12
497FGC	Green	10 1/4 x 5 3/8 x 2	26 x 13.6 x 5.1	12
497FRC	Red	10 1/4 x 5 3/8 x 2	26 x 13.6 x 5.1	12
497FTC	Tan	10 1/4 x 5 3/8 x 2	26 x 13.6 x 5.1	12
497FWC	White	10 1/4 x 5 3/8 x 2	26 x 13.6 x 5.1	12
497FYC	Yellow	10 1/4 x 5 3/8 x 2	26 x 13.6 x 5.1	12

D703, 001



497FGC





ALL-PURPOSE PREP TRAYS

Ideal for the preparation and processing of food in a busy kitchen. The raised grooves and built-in spouts make heating and reheating food a cinch. Versatility from the microwave to dishwasher saves you time, and durable plastic construction eliminates the need for paper waste. These trays are an indispensable tool for any kitchen or chain environment.

ITEM	IN	CM	COLOR	PACK
498FB	9 1/2 x 7 3/16 x 1 5/8	24.1 x 18.3 x 4.1	Blue	24
498FG	9 1/2 x 7 3/16 x 1 5/8	24.1 x 18.3 x 4.1	Green	24
498FR	9 1/2 x 7 3/16 x 1 5/8	24.1 x 18.3 x 4.1	Red	24
498FT	9 1/2 x 7 3/16 x 1 5/8	24.1 x 18.3 x 4.1	Tan	24
498FW	9 1/2 x 7 3/16 x 1 5/8	24.1 x 18.3 x 4.1	White	24
498FY	9 1/2 x 7 3/16 x 1 5/8	24.1 x 18.3 x 4.1	Yellow	24

D638, 137
8, 448, 881

ALL-PURPOSE PREP TRAYS NO RIBS

ITEM	IN	CM	COLOR	PACK
493FB	9 1/2 x 7 3/16 x 1 5/8	24.1 x 18.3 x 4.1	Blue	24
493FG	9 1/2 x 7 3/16 x 1 5/8	24.1 x 18.3 x 4.1	Green	24
493FR	9 1/2 x 7 3/16 x 1 5/8	24.1 x 18.3 x 4.1	Red	24
493FT	9 1/2 x 7 3/16 x 1 5/8	24.1 x 18.3 x 4.1	Tan	24
493FW	9 1/2 x 7 3/16 x 1 5/8	24.1 x 18.3 x 4.1	White	24
493FY	9 1/2 x 7 3/16 x 1 5/8	24.1 x 18.3 x 4.1	Yellow	24



Patent pending





PLASTIC SERVING TRAYS

Anti-slip trays are ideal for table meal service. NSF listed.

ITEM	DESCRIPTION	COLOR	DIMENSIONS (L X W)		PACK
			IN	CM	
 RNST11BLK	Round	Black	11	27.9	12
RNST11BR	Round	Brown	11	27.9	12
RNST14BLK	Round	Black	14	35.6	12
RNST14BR	Round	Brown	14	35.6	12
RNST16BLK	Round	Black	16	40.6	12
RNST16BR	Round	Brown	16	40.6	12
ONST2227BLK	Oval	Black	26 3/4 x 22	67.9 x 55.9	12
ONST2227BR	Oval	Brown	26 3/4 x 22	67.9 x 55.9	12
RNST1216BLK	Rectangular	Black	16 x 12	40.6 x 30.5	12
RNST1216BR	Rectangular	Brown	16 x 12	40.6 x 30.5	12
RNST1418BLK	Rectangular	Black	18 x 14	45.7 x 35.6	12
RNST1418BR	Rectangular	Brown	18 x 14	45.7 x 35.6	12
RNST1520BLK	Rectangular	Black	20 1/4 x 15 1/4	51.4 x 38.7	12
RNST1520BR	Rectangular	Brown	20 1/4 x 15 1/4	51.4 x 38.7	12



CAKE COVER

The one-piece lucite cover is flawless to clearly showcase your creations. The chrome-handled cake cover is durable and odorless. The 0136 stainless steel cake stand featured on page 39 is complemented with this cover.

ITEM	DIAMETER		HEIGHT		PACK
	IN	CM	IN	CM	
CK20512	12	30.5	6 3/8	16.2	12



ASHTRAYS

Break-resistant material withstands heat and resists stains.

ITEM	IN	CM	COLOR	PACK
322ITB	4 1/4 x 1 5/8	10.8 x 4.1	Black	72
322ITR	4 1/4 x 1 5/8	10.8 x 4.1	Red	72

 Economy line offerings are identified by our green e-line icon and matching color-coded chart items.



Economy line offerings are identified by our green e-line icon and matching color-coded chart items.

PITCHER WITH ICE CORE

Freezable ice core keeps beverages colder for longer without dilution. Twist-and-lock core makes for secure pouring and quick replacement. Features a sturdy, ergonomic handle for ease of use and is dishwasher safe.

ITEM	COLOR	CAPACITY		HEIGHT		PACK
		OZ	L	IN	CM	
IP403520	Clear	68	2	9	22.9	1
IP402520BL	Blue	68	2	8 1/2	21.6	1
IP402520G	Green	68	2	8 1/2	21.6	1
IP402520R	Red	68	2	8 1/2	21.6	1
IP402520Y	Yellow	68	2	8 1/2	21.6	1



PCP603



PCP601



PCPT600



POLYCARBONATE PITCHERS

Easy pour pitchers made of durable plastic.

ITEM	SPOUT TYPE	COLOR	CAPACITY		DIAMETER		HEIGHT		PACK
			OZ	L	IN	CM	IN	CM	
 PCP321	Single	Clear	32	0.9	4 1/8	10.5	6	15.2	12
PCP601	Single	Clear	60	1.8	5	12.7	7 1/4	18.4	12
PCP603	Triple	Clear	60	1.8	5	12.7	7 1/2	19.1	12
PCP603A	Triple	Amber*	60	1.8	5	12.7	7 1/2	19.1	12
PCPT600	Single	Clear	60	1.8	5 3/8	13.7	8 1/4	21	12

*Amber color not NSF listed.



POLYCARBONATE FOOD PANS

Provides an alternate use to standard stainless steel steam table pans. Polycarbonate food pans are durable and withstand from -40°F to 210°F (-40°C to 99°C). They do not react with foods therefore minimizing food acid and oil reactions. Clear pans are marked with capacity measurements, dishwasher safe, and stackable. NSF listed.

ITEM	CAPACITY		LENGTH		WIDTH		DEPTH		PACK
	QT	L	IN	MM	IN	MM	IN	MM	
e™ PC22002	8.9	8.5	20 7/8	530	12 3/4	325	2 1/2	65	12
PC22004	13.8	13.2	20 7/8	530	12 3/4	325	4	100	12
PC22006	20.6	19.5	20 7/8	530	12 3/4	325	6	150	12
PC22008	27	25.6	20 7/8	530	12 3/4	325	8	200	12
PC22122	4.1	3.9	12 3/4	325	10 1/2	265	2 1/2	65	12
PC22124	6.3	6.0	12 3/4	325	10 1/2	265	4	100	12
PC22126	9.4	8.9	12 3/4	325	10 1/2	265	6	150	12
PC22128	12.4	11.7	12 3/4	325	10 1/2	265	8	200	12
PC22132	2.6	2.5	12 3/4	325	7	176	2 1/2	65	12
PC22134	3.8	3.5	12 3/4	325	7	176	4	100	12
PC22136	5.6	5.3	12 3/4	325	7	176	6	150	12
PC22138	7.3	6.9	12 3/4	325	7	176	8	200	12
PC22142	1.7	1.6	10 1/2	265	6 3/8	162	2 1/2	65	12
PC22144	2.6	2.5	10 1/2	265	6 3/8	162	4	100	12
PC22146	3.9	3.7	10 1/2	265	6 3/8	162	6	150	12
PC22162	1.1	1.0	7	176	6 3/8	162	2 1/2	65	12
PC22164	1.6	1.5	7	176	6 3/8	162	4	100	12
PC22166	2.3	2.2	7	176	6 3/8	162	6	150	12
PC22192	0.6	0.6	7	176	4 1/4	108	2 1/2	65	12
PC22194	0.9	0.8	7	176	4 1/4	108	4	100	12



POLYCARBONATE DRAIN SHELVES

Sturdy footing support food content and allows for easy draining. Dishwasher safe. NSF listed.

ITEM	DESCRIPTION	IN	CM	PACK
e™ PCD100	Full Size	18 1/4 x 10 1/4	46.4 x 26	12
PCD50	Half Size	10 1/4 x 7 7/8	26 x 20	12
PCD33	Third Size	10 1/4 x 4 3/8	26 x 11.1	12
PCD25	Quarter Size	8 x 4	20.3 x 10.2	12
PCD16	Sixth Size	4 1/2 x 4	11.4 x 10.2	12



POLYCARBONATE FOOD PAN COVERS

Clear cover allows you to see food contents. Easy to clean and dishwasher safe. NSF listed.

ITEM	FITS PAN	IN	CM	PACK
e™ PCC22002	Full Size	20 5/8 x 12 3/4	52.4 x 32.4	12
PCC22122	Half Size	12 5/8 x 10 1/4	32.1 x 26	12
PCC22132	One-Third Size	12 3/4 x 6 7/8	32.4 x 17.5	12
PCC22142	One-Fourth Size	10 3/8 x 6 3/8	26.4 x 16.2	12
PCC22162	One-Sixth Size	6 7/8 x 6 3/8	32.4 x 16.2	12
PCC22192	One-Ninth Size	6 7/8 x 4 1/4	32.4 x 10.8	12

NOTCHED COVERS

e™ PCC22002NC	Full Size	20 5/8 x 12 3/4	52.4 x 32.4	12
PCC22122NC	Half Size	12 5/8 x 10 1/4	32.1 x 26	12
PCC22132NC	One-Third Size	12 3/4 x 6 7/8	32.4 x 17.5	12
PCC22142NC	One-Fourth Size	10 3/8 x 6 3/8	26.4 x 16.2	12
PCC22162NC	One-Sixth Size	6 7/8 x 6 3/8	32.4 x 16.2	12
PCC22192NC	One-Ninth Size	6 7/8 x 4 1/4	32.4 x 10.8	12

e™ All items on this page are part of our economy line offerings, identified by our green e-line icon and matching color-coded chart items.



POLYCARBONATE STORAGE CONTAINERS

These storage containers help keep food fresh. They are durable, stackable, and withstand from -40°F to 210°F (-40°C to 99°C). Clear polycarbonate containers are marked on outside with color capacity graduations. Dishwasher safe and NSF listed.

ITEM	DESCRIPTION	CAPACITY		DIAMETER		DEPTH		COVER TO FIT	PACK
		QT	L	IN	CM	IN	CM		
 PCSC1R	Round	1 1/16	1	5 1/4	13.3	5	12.7	PCCR1	24
PCSC2R	Round	2 1/8	2	7 1/4	18.4	4 1/4	10.8	PECR24W,R,G	12
PCSC4R	Round	4 1/4	4	7 1/4	18.4	8 1/2	21.6	PECR24W,R,G	12
PCSC6R	Round	6 3/8	6	8 7/8	22.5	8	20.3	PECR68W,R,G	12
PCSC8R	Round	8	7.5	8 7/8	22.5	11	27.9	PECR68W,R,G	6
PCSC10R	Round	12	11	12 3/8	31.4	8 1/4	20.9	PECR101519W,R,G	6
PCSC15R	Round	18	17	12 3/8	31.4	12	30.5	PECR101519W,R,G	6
PCSC19R	Round	20	19	12 3/8	31.4	14 7/8	37.8	PECR101519W,R,G	6
PCSC1S	Square	2	2	7 1/4 x 7 1/4	18.4 x 18.4	3 3/4	9.5	PECS13W,R,G	24
PCSC3S	Square	3 3/4	3.5	7 1/4 x 7 1/4	18.4 x 18.4	7 1/4	18.4	PECS13W,R,G	12
PCSC5S	Square	6	5.7	8 7/8 x 8 7/8	22.5 x 22.5	7	17.8	PECS57W,R,G	12
PCSC7S	Square	7 1/2	7	8 3/4 x 8 3/4	22.2 x 22.2	9	22.9	PECS57W,R,G	12
PCSC10S	Square	12	11.4	1 3/8 x 11 3/8	28.9 x 28.9	8 1/4	21	PECS1016W,R,G	6
PCSC16S	Square	18	17	1 3/8 x 11 3/8	28.9 x 28.9	12 5/8	32.1	PECS1016W,R,G	6

STORAGE CONTAINER COVERS



ITEM	DESCRIPTION	DIAMETER		COVER FITS	PACK
		IN	CM		
 PCCR1	Round	5 1/3	13.5	PCSC1R	12
PECR24W	Round	7 2/5	18.8	PCSC2R,PCSC4R	12
PECR24R	Round	7 2/5	18.8	PCSC2R,PCSC4R	12
PECR24G	Round	7 2/5	18.8	PCSC2R,PCSC4R	12
PECR68W	Round	9	22.9	PCSC6R,PCSC8R	12
PECR68R	Round	9	22.9	PCSC6R,PCSC8R	12
PECR68G	Round	9	22.9	PCSC6R,PCSC8R	12
PECR101519W	Round	12 3/5	32	PCSC10R,PCSC15R, PCSC19R	12
PECR101519R	Round	12 3/5	32	PCSC10R,PCSC15R, PCSC19R	12
PECR101519G	Round	12 3/5	32	PCSC10R,PCSC15R, PCSC19R	12
PECS13W	Square	7 1/2	19	PCSC1S,PCSC3S	12
PECS13R	Square	7 1/2	19	PCSC1S,PCSC3S	12
PECS13G	Square	7 1/2	19	PCSC1S,PCSC3S	12
PECS57W	Square	9	22.9	PCSC5S,PCSC7S	12
PECS57R	Square	9	22.9	PCSC5S,PCSC7S	12
PECS57G	Square	9	22.9	PCSC5S,PCSC7S	12
PECS1016W	Square	11 3/5	29.5	PCSC10S,PCSC16S	12
PECS1016R	Square	11 3/5	29.5	PCSC10S,PCSC16S	12
PECS1016G	Square	11 3/5	29.5	PCSC10S,PCSC16S	12



All items on this page are part of our economy line offerings, identified by our green e-line icon and matching color-coded chart items.

POLYCARBONATE LIQUID MEASURES

Easy pour plastic measuring cups provide accurate liquid capacities.

ITEM	CAPACITY			PACK
	QT	ML		
 PCML05	½	473		12
PCML10	1	946		12
PCML20	2	1892		12
PCML30	3	2838		12
PCML50	5	4730		12



PLASTIC TUMBLERS

Made of break-resistant SAN plastic with a textured exterior. Stackable and dishwasher safe.

ITEM	COLOR	CAPACITY		HEIGHT		PACK
		OZ	ML	IN	CM	
 PT5A	Amber	5	147.9	3 5/8	9.2	12
PT5C	Clear	5	147.9	3 5/8	9.2	12
PT5R	Red	5	147.9	3 5/8	9.2	12
PT5B	Blue	5	147.9	3 5/8	9.2	12
PT8A	Amber	8	236.6	3 7/8	9.8	12
PT8C	Clear	8	236.6	3 7/8	9.8	12
PT8R	Red	8	236.6	3 7/8	9.8	12
PT8B	Blue	8	236.6	3 7/8	9.8	12
PT9A	Amber	9.5	280.9	4 1/4	10.8	12
PT9C	Clear	9.5	280.9	4 1/4	10.8	12
PT9R	Red	9.5	280.9	4 1/4	10.8	12
PT9B	Blue	9.5	280.9	4 1/4	10.8	12
PT12A	Amber	12	354.9	5	12.7	12
PT12C	Clear	12	354.9	5	12.7	12
PT12R	Red	12	354.9	5	12.7	12
PT12B	Blue	12	354.9	5	12.7	12
PT16A	Amber	16	473.2	5 3/4	14.6	12
PT16C	Clear	16	473.2	5 3/4	14.6	12
PT16R	Red	16	473.2	5 3/4	14.6	12
PT16B	Blue	16	473.2	5 3/4	14.6	12
PT20A	Amber	20	591.5	6 1/2	16.5	12
PT20C	Clear	20	591.5	6 1/2	16.5	12
PT20R	Red	20	591.5	6 1/2	16.5	12
PT20B	Blue	20	591.5	6 1/2	16.5	12
PT32A	Amber	32	946.4	7 1/4	18.4	12
PT32C	Clear	32	946.4	7 1/4	18.4	12
PT32R	Red	32	946.4	7 1/4	18.4	12
PT32B	Blue	32	946.4	7 1/4	18.4	12

All items shrink-wrapped. All items sold by pack in master case quantity only.



Polycarbonate Serving Utensils

A variety of polycarbonate utensils designed for salad bar and back of the house use. NSF listed.



BASTING SPOONS

ITEM	COLOR	DESCRIPTION	O/A LENGTH		PACK
			IN	CM	
 PC3760-10	White	Solid	13	33	12
PC3762-10	White	Perforated	13	33	12
PC3760-20	Red	Solid	13	33	12
PC3762-20	Red	Perforated	13	33	12
PC3760-30	Green	Solid	13	33	12
PC3762-30	Green	Perforated	13	33	12
PC3760-40	Clear-Blue Tint	Solid	13	33	12
PC3762-40	Clear-Blue Tint	Perforated	13	33	12
PC3760-50	Black	Solid	13	33	12
PC3762-50	Black	Perforated	13	33	12
PC3760-60	Beige	Solid	13	33	12
PC3762-60	Beige	Perforated	13	33	12



TONGS

ITEM	COLOR	LENGTH		PACK
		IN	CM	
 PC3506-10	White	6	15.2	12
PC3506-20	Red	6	15.2	12
PC3506-30	Green	6	15.2	12
PC3506-40	Clear-Blue Tint	6	15.2	12
PC3506-50	Black	6	15.2	12
PC3506-60	Beige	6	15.2	12
PC3507-10	White	7	17.8	12
PC3507-20	Red	7	17.8	12
PC3507-30	Green	7	17.8	12
PC3507-40	Clear-Blue Tint	7	17.8	12
PC3507-50	Black	7	17.8	12
PC3507-60	Beige	7	17.8	12
PC3509-10	White	9	22.9	12
PC3509-20	Red	9	22.9	12
PC3509-30	Green	9	22.9	12
PC3509-40	Clear-Blue Tint	9	22.9	12
PC3509-50	Black	9	22.9	12
PC3509-60	Beige	9	22.9	12
PC3512-10	White	12	30.5	12
PC3512-20	Red	12	30.5	12
PC3512-30	Green	12	30.5	12
PC3512-40	Clear-Blue Tint	12	30.5	12
PC3512-50	Black	12	30.5	12
PC3512-60	Beige	12	30.5	12

LADLES

1 oz., 29.6 ml capacity

ITEM	COLOR	HANDLE		PACK
		IN	CM	
 PC8841-10	White	7 1/2	19.1	12
PC8841-20	Red	7 1/2	19.1	12
PC8841-30	Green	7 1/2	19.1	12
PC8841-40	Clear-Blue Tint	7 1/2	19.1	12
PC8841-50	Black	7 1/2	19.1	12
PC8841-60	Beige	7 1/2	19.1	12



SAUCE LADLES

1/2 oz., 15 ml capacity

ITEM	COLOR	LENGTH		PACK
		IN	CM	
 PC1011-10	White	11	27.9	12
PC1011-20	Red	11	27.9	12
PC1011-30	Green	11	27.9	12
PC1011-40	Clear-Blue Tint	11	27.9	12
PC1011-50	Black	11	27.9	12
PC1011-60	Beige	11	27.9	12

SALAD SPOONS

3/4 oz., 22.2 ml capacity

ITEM	COLOR	O/A LENGTH		PACK
		IN	CM	
 PC6639-10	White	10 1/4	26	12
PC6639-20	Red	10 1/4	26	12
PC6639-30	Green	10 1/4	26	12
PC6639-40	Clear-Blue Tint	10 1/4	26	12
PC6639-50	Black	10 1/4	26	12
PC6639-60	Beige	10 1/4	26	12



 All items on this page are part of our economy line offerings, identified by our green e-line icon and matching color-coded chart items.



CHAFERS & BUFFETWARE

Savoir™ Chafers
76 - 80

Orbit™ Buffetware
83

Sonata Serenade™ Chafers
84 - 87

Silvercrest™/Goldcrest™
Buffetware
88 - 89

Cordiale™ Chafers
90

Barocco Serving Ware
91

New Era Serving Ware
91

Top-Shelf™ Chafers
92 - 95

Chafer Components
96 - 97

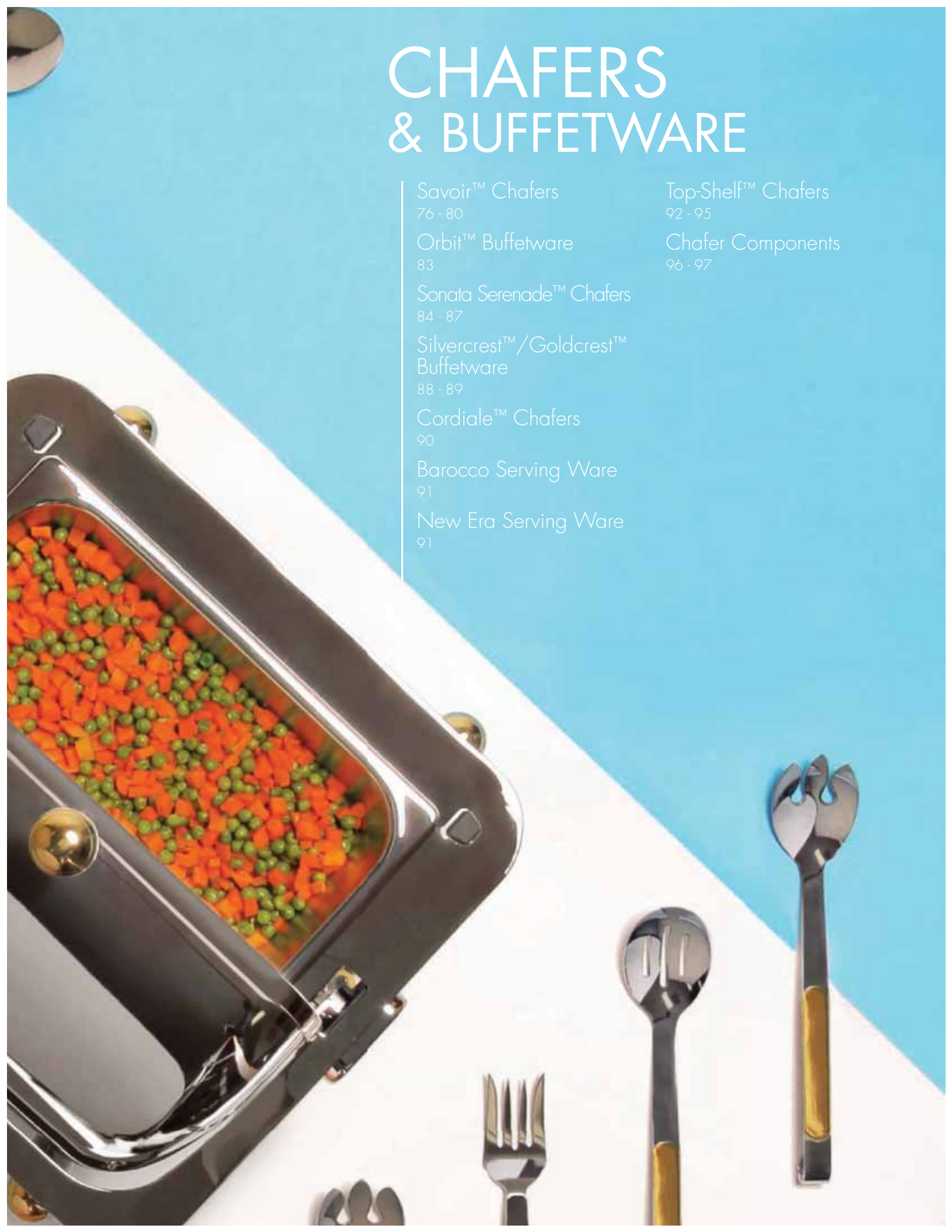

Savoir™ Chafers

When presentation is paramount, superior styling and ease of use make Savoir Chafers the top choice. The collection is made of the finest 18/10 stainless steel and polished to a highly mirrored finish, allowing each model to showcase its own superb quality and exquisite design. In full, half, and two sizes of round chafer, Savoir boasts a fanciful brass-trimmed model, and a contemporary flat stainless steel version with European styling. They're as functional and sturdy as they are elegant, built for heavy-duty use in any busy foodservice environment.



FULL SIZE DOME COVER CHAFING DISH

ITEM	IN	CM	PACK
AL500A	25 1/2 x 17 7/8 x 18	64.7 x 45.4 x 45.7	1



HALF SIZE DOME COVER CHAFING DISH

ITEM	IN	CM	PACK
AL520A	17 x 15 1/8 x 15 1/2	43.2 x 38.4 x 39.4	1



Savoir Chafer Features

Full roll top opens at 90° and 180°. Clutch mechanism ensures proper position of roll top. Detachable cover for easy handling and cleaning. Includes full frame, water pan, food pan, and drop-in fuel holders, as pictured.



FULL SIZE DOME COVER CHAFING DISH - BRASS LEGS

ITEM	IN	CM	PACK
AL510A	25 1/2 x 17 7/8 x 18 3/8	64.7 x 45.4 x 46.7	1



HALF SIZE DOME COVER CHAFING DISH - BRASS LEGS

ITEM	IN	CM	PACK
AL530A	17 x 15 1/8 x 15 5/8	43.2 x 38.4 x 39.7	1



13" ROUND CHAFING DISH

ITEM	O/A DIAMETER		HEIGHT		PACK
	IN	CM	IN	CM	
AL540A	15 1/4	38.7	16 1/4	41.3	1



15" ROUND CHAFING DISH

ITEM	O/A DIAMETER		HEIGHT		PACK
	IN	CM	IN	CM	
AL550A	17 3/8	44.1	18 1/4	46.4	1



13" ROUND CHAFING DISH - BRASS LEGS

ITEM	O/A DIAMETER		HEIGHT		PACK
	IN	CM	IN	CM	
AL560A	16	40.6	16 1/4	41.3	1



15" ROUND CHAFING DISH - BRASS LEGS

ITEM	O/A DIAMETER		HEIGHT		PACK
	IN	CM	IN	CM	
AL570A	18	45.7	18 1/2	47	1



AL540AE



ELECTRIC SAVOIR™ CHAFERS

Alegacy has broadened its selection of fine Savoir chafers with an electric conversion option. All Savoir chafers are available with electric heat components as well as the original canned heat fuel holders. Whether your buffet service is indoors or outdoors, on the patio or veranda, the Savoir line now meets all your heating needs.

ITEM	DESCRIPTION	PACK
AL500AE	Full Size - Electric	1
AL510AE	Full Size w/ Brass Legs - Electric	1
AL520AE	Half Size - Electric	1
AL530AE	Half Size w/ Brass Legs - Electric	1
AL540AE	13" Round - Electric	1
AL550AE	15" Round - Electric	1
AL560AE	13" Round w/ Brass Legs - Electric	1
AL570AE	15" Round w/ Brass Legs - Electric	1

*Electric chafers item specifications are same as non-electric versions



WATER PAN & HEATING PLATES FOR SAVOIR CHAFERS

Electric unit attaches to water pans listed. Water pans may also be used with non-electric heating source.

ITEM	DESCRIPTION	FITS MODELS	PACK
AL540WPE	Water Pan	AL540, AL560	1
AL550WPE	Water Pan	AL550, AL570	1
AL520WPE	Water Pan	AL520, AL530	1
AL500WPE	Water Pan	AL500, AL510	1
ELH100	Heating Plate *	AL500, AL510	1
ELH110	Heating Plate **	AL540, AL550, AL560, AL570, AL520, AL530	1

* Heating plate for 120V / 700W usage. UL and CE certified.

** Heating plate for 120V / 300W usage. UL and CE certified.



AL1002



RD1006



AL1001

Savoir Induction Chafers

Buffet service is brought to new heights with our latest addition of induction chafing dishes in a variety of shapes and sizes. Each chafing dish is equipped with a multi-layer metal bottom that allows for induction or canned fuel heating sources. This range of chafing dishes comes with an all stainless steel cover that can automatically be held open at 60 degrees for food service.

SAVOIR INDUCTION CHAFERS

ITEM	WITH STAND	DESCRIPTION	CAPACITY		DIAMETER		DEPTH		PACK	STAND TO FIT
			QT	L	IN	CM	IN	CM		
AL1000	AL1000A	Full Size	9.5	9	23 x 17 ¾	58.4 x 44.8	8 ¾	22.2	1	ST1000
AL1001	AL1001A	Two-third Size	5.8	5 ½	18 x 16	45.7 x 40.6	9	22.9	1	ST1001
AL1002	AL1002A	Half Size	4.2	4	17 ¾ x 12 ½	45.1 x 31.7	9	22.9	1	ST1002
RD1006	RD1006A	Round	6.3	6	20 x 17 ¾	50.8 x 45.1	9	22.9	1	ST1006
RD1004	RD1004A	Round	4.2	4	18 x 15 ¼	45.7 x 38.7	8 5/8	21.9	1	ST1004
RD1011	RD1011A	Round	11.6	11	19 ¼	48.9	13	33	1	ST1011



ST1002



AL1000A



RD1004A



RD1011A

CHAFING DISH STAND

Our elegantly-styled stand allows chafing dish to be heated alternatively with canned fuel.

ITEM	DESCRIPTION	O/A DIAMETER		HEIGHT		PACK	FITS
		IN	CM	IN	CM		
ST1000	Full Size	17 x 21 ¼	43.2 x 54	4 ¾	12.1	1	AL1000
ST1001	Two-third Size	17 x 14 ½	43.2 x 54	4 ¾	12.1	1	AL1001
ST1002	Half Size	16 ¾ x 11 ½	42.5 x 29.2	4 ¾	12.1	1	AL1002
ST1006	Round	17 x 12	43.2 x 30.5	4 ¾	12.1	1	RD1006
ST1004	Round	15 ¼ x 11	38.7 x 27.9	4 ¾	12.1	1	RD1004
ST1011	Round	17 x 12	43.2 x 30.5	4 ¾	12.1	1	RD1011

Chafers available separately or with stand.



COFFEE URNS & HEATING PLATE

Sleek and elegant design crafted in 18/10 stainless steel and perfect for formal and informal occasions. Either fuel burner or electric heating unit for serving (no brewing). Available in stainless or with brass trim.



AL920

AL940



AL930

AL950



AL910

ITEM	CAPACITY		
	QT	L	PACK
AL940	6.3	6	1
AL920	12.6	12	1
AL950	6.3	6	1
AL930	12.6	12	1
ELH120	*Heating Plate		1

*Heating plate for 100/120V 170W usage. UL and CE certified.



Optional heating unit

ELH120



AL900

JUICE DISPENSER

Sleek transparent exterior crafted in 18/10 stainless steel. Comes with special insert for ice. Easy to clean and ideal for formal and informal occasions. Available in stainless or with brass accents.

ITEM	CAPACITY		
	QT	L	PACK
AL900	7.37	7	1
AL910	7.37	7	1

COFFEE SERVERS

18/10 stainless steel. Well accepted in foodservice, hotels, airlines, and cruise lines.

ITEM	CAPACITY		
	OZ	ML	PACK
AL1140	12	360	1
AL1130	18	540	1
AL1120	30	900	1
AL1110	56	1680	1
AL1100	70	2100	1





WATER PITCHER WITH ICE GUARD

ITEM	CAPACITY			PACK
	OZ	ML		
AL1150	70	2100		1



CREAMERS

ITEM	CAPACITY			PACK
	OZ	ML		
AL1170	5	150		1
AL1160	8	240		1



GRAVY BOAT WITH STEPPED BOTTOM

Update your gravy boat from a "Jurassic" to a classic. Made of the highest quality 18/8 stainless steel and featuring a highly polished mirrored finish, this boat adds a touch of class to any event. The tri-stepped bottom creates an elegant serving piece for your finest sauces and gravies.

ITEM	CAPACITY			PACK
	OZ	ML		
2108	8	237		12
2110	10	296		12
2116	16	473.6		12



SUGAR BOWL WITH LID

ITEM	CAPACITY			PACK
	OZ	ML		
AL1180	10	300		1



ICE CREAM CUP

Made of 18/8 stainless steel and finished with a high mirror polish, these cups are ideal for elegant dessert service.

ITEM	CAPACITY			HEIGHT		PACK
	OZ	ML		IN	CM	
2100	4	118		2 ³ / ₁₆	5.6	12

Orbit™ Buffetware

Why settle for less when you can have the best? With a gracefully hooked handle and highly polished stainless steel finish, our Orbit buffetware insures your clients' guests are served in the utmost style. Select from satin or gold trimmed handles, with even weighting and balance for ease of service.

STAINLESS STEEL HANDLE

ITEM	DESCRIPTION	OVERALL LENGTH		PACK
		IN	CM	
211	Solid Spoon	11 7/8	30.2	12
212	Slotted Spoon	11 7/8	30.2	12
213	Notched Salad Spoon	11 7/8	30.2	12
214	Deep Ladle 4 oz	12 7/8	31.4	12
218	Pie Server	11 7/8	30.2	12
220	Cold Meat Fork	10 7/8	26.7	12

D474,658



GOLD TRIM HANDLE

ITEM	DESCRIPTION	OVERALL LENGTH		PACK
		IN	CM	
211GD	Solid Spoon	11 7/8	30.2	12
212GD	Slotted Spoon	11 7/8	30.2	12
213GD	Notched Salad Spoon	11 7/8	30.2	12
214GD	Deep Ladle 4 oz	12 3/8	31.4	12
218GD	Pie Server	11 7/8	30.2	12
220GD	Cold Meat Fork	10 1/2	26.7	12

D474,658



Sonata Serenade™ Chafers

With such a wide range of styles, you'll have no trouble finding a Sonata Serenade chafers to fit your needs and bring elegance and fantastic value to your buffet. The line comes in either brass or polished stainless steel trim detail. The high quality roll top covers remain open for one-handed serving and easy refilling. Plus, the highly polished stainless steel exterior is attractive and easy to clean.



FULL SIZE "ROLL TOP" CHAFER

Strong, welded frame with built-in handles and a roll top cover. Includes a dripless water pan, a full size food pan, and two drop-in fuel holders.

ITEM	IN	CM	PACK
AL400RTA	22 x 14 1/4 x 15 3/8	55.9 x 36.2 x 39.1	1

ROUND "ROLL TOP" CHAFER

Four-legged, secure frame with roll top dome cover of mirror finished stainless steel. Includes water pan, food pan, and a drop-in fuel holder.

ITEM	DIAMETER		HEIGHT		PACK
	IN	CM	IN	CM	
RD400RTA	16	40.6	17	43.2	1

Foodservice Products Group, Inc.
Alegacy®

Serving chefs since 1947.™





AL100A

FULL SIZE CHAFING DISH

Stackable frame made of stainless steel with a mirror finish. Roll top cover opens to 90 and 180 degrees. 8 qt. capacity.



AL101A

FULL SIZE CHAFING DISH

See-thru stackable frame made of stainless steel with a mirror finish. Roll top cover, with see-thru window opens to 90 and 180 degrees. 8 qt. capacity.



AL200A

FULL SIZE CHAFING DISH

Made of stainless steel with a mirror finish. Roll top cover opens to 90 and 180 degrees. 8 qt. capacity.



AL200GA

FULL SIZE CHAFING DISH

Made of stainless steel with a mirror finish with gold accented legs and handle. Roll top cover opens to 90 and 180 degrees. 8 qt. capacity.

See-thru window for
AL101A + AL401A



ITEM	DESCRIPTION	IN	CM	PACK
 AL100A	Full Size Roll-Top Chafer-Stackable Frame	25 1/2 x 18 x 17 3/4	64.7 x 45.2 x 45	1
AL101A	Full Size Roll-Top Chafer w/ Window-Stackable Frame	25 1/2 x 18 x 17 3/4	64.7 x 45.2 x 45	1
AL200A	Full Size Roll-Top Chafer	24 1/2 x 16 3/4 x 17 3/4	62.2 x 42.5 x 45	1
AL200GA	Full Size Roll-Top Chafer-Gold Accented	24 1/2 x 16 3/4 x 17 3/4	62.2 x 42.5 x 45	1

 Economy line offerings are identified by our green e-line icon and matching color-coded chart items.



AL201A

15" ROUND CHAFING DISH

Made of stainless steel with a mirror finish. Roll top cover opens to 90 and 180 degrees. 6 qt. capacity.



AL201GA

15" ROUND CHAFING DISH

Made of stainless steel with a mirror finish and gold accented legs and handle. Roll top cover opens to 90 and 180 degrees. 6 qt. capacity.



Fuel holder



Handle

ITEM	DESCRIPTION	IN	CM	PACK
 AL201A	Round Roll-Top Chafer	17 1/2 x 18 3/4	44.4 x 47.6	1
AL201GA	Round Roll-Top Chafer-Gold Accented	19 x 18 3/4	48.2 x 47.6	1

 Economy line offerings are identified by our green e-line icon and matching color-coded chart items.



AL400A

15" ROUND CHAFING DISH

Stackable frame made of stainless steel with a mirror finish. Roll top cover opens to 90 and 180 degrees. 6 qt. capacity.



AL402A

OVAL CHAFING DISH

Stackable frame made of stainless steel with a mirror finish. Roll top cover opens to 90 and 180 degrees. 9 1/2 qt capacity.



AL401A

15" ROUND CHAFING DISH

Stackable frame made of stainless steel with a mirror finish. Roll top cover, with a see-thru window opens to 90 and 180 degrees. 6 qt. capacity.



See-thru window for AL101A + AL401A

ITEM	DESCRIPTION	IN	CM	PACK
 AL400A	Round Roll-Top Chafer-Stackable Frame	19 x 18	48.2 x 45.7	1
AL401A	Round Roll-Top Chafer w/ Window-Stackable Frame	19 x 18	48.2 x 45.7	1
AL402A	Oval Roll-Top Chafer-Stackable Frame	25 3/4 x 19 3/4 x 18	65.4 x 50.2 x 45.7	1

 Economy line offerings are identified by our green e-line icon and matching color-coded chart items.

Silvercrest™ Buffetware

Silvercrest/Goldcrest serving ware is crafted from heavy gauge stainless steel with a hollow handle finger grip design. The practical one-piece construction makes it durable and easy to clean. Comes in two finishes: Silvercrest, the original silver finish, and Goldcrest, a gold finish.



SILVERCREST™ BUFFETWARE

ITEM	DESCRIPTION	OVERALL LENGTH		PACK
		IN	CM	
111	Solid Serving Spoon	11 3/4	29.8	12
112	Slotted Serving Spoon	11 3/4	29.8	12
113NSS	Notched Serving Spoon	11 5/8	29.5	12
114DL	Deep Ladle 4 oz	12	30.5	12
1155L	Spout Ladle 1 oz	11	27.9	12
11512	Spout Ladle 2 oz	11	27.9	12
117PS	Pastry Server	11 3/4	29.8	12
118PS	Pie Server	11	27.9	12
119	Perforated Turner	14 1/2	36.8	12
120	Cold Meat Fork	10 3/8	26.7	12
121PF	Pot Fork	11 3/16	28.4	12
122	Slicer Knife (Wave Cut)	13 1/2	34.2	12
124	Carving Knife (Wave Cut)	12 7/8	32.7	12
126	Skimmer	14 1/4	36.2	12
128CP	Cheese Plane	11	27.9	12
129	Hollow Handle/Pistol Grip Carving Knife	13	33.7	12
130	Hollow Handle/Pistol Grip Carving Fork	11	27.9	12





Goldcrest™ Buffetware



GOLDCREST™ BUFFETWARE

ITEM	DESCRIPTION	OVERALL LENGTH		PACK
		IN	CM	
111GD	Solid Spoon	11 3/4	29.8	12
112GD	Slotted Spoon	11 3/4	29.8	12
113NSSGD	Notched Salad Spoon	11 5/8	29.5	12
114DLGD	Deep Ladle 4 oz	12	30.5	12
115SLGD	Spout Ladle 1 oz	11	27.9	12
11512GD	Spout Ladle 2 oz	11	29.8	12
117PSGD	Pastry Server	11 3/4	29.8	12
118PSGD	Pie Server	11	27.9	12
119GD	Perforated Turner	14 1/2	36.8	12
120GD	Cold Meat Fork	10 3/8	26.7	12
121PFGD	Pot Fork	11 3/16	28.4	12
122GD	Slicer 13.5"	13 1/2	34.2	12
126GD	Skimmer	14 1/4	36.2	12

Cordiale™ Chafers

Alegacy's collection of Cordiale deluxe chafers can be mixed and matched to add diversity to any catering line. The satin finished chafers have beautifully detailed turned legs, wood handles, and dome covers to attractively present your dishes. Stainless steel construction makes them dent-resistant and virtually maintenance-free. Built-in platform recesses to accommodate fuel holders.



DELUXE FULL SIZE CHAFER

Chafers includes one frame with legs and handles, one 4 1/2" (11.4 cm) deep dripless water pan, one 2 1/2" (6.4 cm) deep full size pan, two fuel holders, and one dome cover with handle.

ITEM	IN	CM	PACK
DL200A	26 x 14 x 16 1/4	66 x 35.6 x 41.3	1



DELUXE HALF SIZE CHAFER

Chafers comes with 4 3/8" (11.1 cm) deep half size water pan, one 2 1/2" (6.4 cm) deep half size pan, one frame with legs and handles, one fuel holder, and a dome cover with handle.

ITEM	IN	CM	PACK
DL801A	18 x 11 3/4 x 16 1/4	45.7 x 29.8 x 41.3	1



DELUXE ROUND CHAFER

Chafers includes one frame with four legs and two handles, one 5" (12.7 cm) deep water pan 13 1/2" (34.3 cm) in diameter, one 4" (10.2 cm) deep food pan, one fuel holder, and one round dome cover with handle.

ITEM	DIAMETER		HEIGHT		PACK
	IN	CM	IN	CM	
RD130A	13 1/4	33.7	15 3/4	40	1



Barocco Serving Ware

An excellent choice for convenient serving and safe food handling. Made from heavy gauge stainless steel with beautifully designed handles and a mirror polished finish, Barocco serving ware is perfect for elegant service or back of the house utility.



ITEM	DESCRIPTION	OVERALL LENGTH		
		IN	CM	PACK
DSP11	Solid Serving Spoon	11 1/2	29.2	12
DSP13	Solid Serving Spoon	13	33	12
DSP11P	Perforated Serving Spoon	11	27.9	12
DSP13P	Perforated Serving Spoon	13	33	12
DF13	Serving Fork	13	33	12

ITEM	OVERALL LENGTH		CAPACITY		
	IN	CM	OZ	ML	PACK
DL28	8	20.3	2	51.9	12
DL411	11	27.9	4	118.3	12



New Era Serving Ware

The simple but elegant design of New Era is made of heavy gauge stainless steel, with one-piece construction. A satin finish makes this collection a functional, stylish addition to any dining room or salad bar.



ITEM	DESCRIPTION	OVERALL LENGTH		
		IN	CM	PACK
812BS	Oval Basting Spoon	12 1/2	21.7	12
813	Jumbo Spoon	11 1/2	29.2	12
815	Serving Fork	12 1/2	31.7	12
816	Jumbo Spoon Fork	12	30.5	12
817	Square Bowl Spoon	8 1/2	21.6	12
818	Round Bowl Spoon	7 3/4	19.7	12
819	Serving Ladle	6 1/4	15.9	12
820	Cold Meat Fork	8 1/2	21.6	12
822	Pie Server	10	25.4	12

Top-Shelf™ Chafers

Our updated collection of Top-Shelf chafers is perfect for customizing your clients' buffet. Our widened variety of pans makes more combinations possible, so your serving options increase. This, of course, makes for happy servers as well as customers. Now your clients can easily expand their menu selections or even serve small groups. Our durable and solidly constructed chafers are as functional and sturdy as they are elegant, built for heavy-duty use in any busy foodservice environment.

The original Six in One® Chafer

Catering is more practical with Alegacy's Six in One. This lightweight portable chafer is versatile, elegant, and ideal for everything from dinner parties to banquets. A combination of optional anti-jamming steam pans allows your customers to customize for any occasion. So whether they are used to serve appetizers or side dishes, the Six in One is the smartest way to go.



THE ORIGINAL SIX IN ONE CHAFER

ITEM	FINISH	DESCRIPTION	CAPACITY		IN	CM	PACK
			QT	L			
AL320A	Stainless Steel	Basic Model	2.6	2.5	17 x 8 x 12 1/2	43.2 x 20.3 x 31.8	1
AL320GA	Gold Accented	Basic Model	2.6	2.5	17 x 8 x 12 1/2	43.2 x 20.3 x 31.8	1
AL324A	Stainless Steel	Basic+88134	4.1	3.9	17 x 8 x 12 1/2	43.2 x 20.3 x 31.8	1
AL324GA	Gold Accented	Basic+88134	4.1	3.9	17 x 8 x 12 1/2	43.2 x 20.3 x 31.8	1
AL326A	Stainless Steel	Basic+88162	1.2	1.1	17 x 8 x 12 1/2	43.2 x 20.3 x 31.8	1
AL326GA	Gold Accented	Basic+88162	1.2	1.1	17 x 8 x 12 1/2	43.2 x 20.3 x 31.8	1
AL346A	Stainless Steel	Basic+88164	1.8	1.7	17 x 8 x 12 1/2	43.2 x 20.3 x 31.8	1
AL346GA	Gold Accented	Basic+88164	1.8	1.7	17 x 8 x 12 1/2	43.2 x 20.3 x 31.8	1
AL329A	Stainless Steel	Basic+88192	.6	.5	17 x 8 x 12 1/2	43.2 x 20.3 x 31.8	1
AL329GA	Gold Accented	Basic+88192	.6	.5	17 x 8 x 12 1/2	43.2 x 20.3 x 31.8	1
AL349A	Stainless Steel	Basic+88194	1.1	1	17 x 8 x 12 1/2	43.2 x 20.3 x 31.8	1
AL349GA	Gold Accented	Basic+88194	1.1	1	17 x 8 x 12 1/2	43.2 x 20.3 x 31.8	1
AL390A	Stainless Steel	Basic+All Pans	Interchangeable		17 x 8 x 12 1/2	43.2 x 20.3 x 31.8	1
AL390GA	Gold Accented	Basic+All Pans	Interchangeable		17 x 8 x 12 1/2	43.2 x 20.3 x 31.8	1



AL420GA



AL420A

FULL SIZE CHAFER

ITEM	DESCRIPTION	CAPACITY				PACK
		QT	L	IN	CM	
AL420A	Stainless Steel	9	8.6	23 1/4 x 14 x 13 3/4	59.1 x 35.6 x 34.9	1
AL420GA	Gold Accented	9	8.6	23 1/4 x 14 x 13 3/4	59.1 x 35.6 x 34.9	1



AL422A



AL422GA

HALF SIZE CHAFER

ITEM	DESCRIPTION	CAPACITY				PACK
		QT	L	IN	CM	
AL422A	Stainless Steel	4	3.8	15 1/4 x 11 1/2 x 13	38.7 x 29.2 x 33	1
AL422GA	Gold Accented	4	3.8	15 1/4 x 11 1/2 x 13	38.7 x 29.2 x 33	1



AL428A



AL428GA

OVAL CHAFER

ITEM	DESCRIPTION	CAPACITY		IN	CM	PACK
		QT	L			
AL428A	Stainless Steel	6	5.7	20 1/2 x 12 1/4 x 12 3/4	52.1 x 31.1 x 32.4	1
AL428GA	Gold Accented	6	5.7	20 1/2 x 12 1/4 x 12 3/4	52.1 x 31.1 x 32.4	1

ROUND CHAFER



AL424A



AL424GA

ITEM	DESCRIPTION	CAPACITY		IN	CM	PACK
		QT	L			
AL424A	Stainless Steel	4	3.8	15 1/4 x 12 1/2 x 11 3/4	38.7 x 31.7 x 28.8	1
AL424GA	Gold Accented	4	3.8	15 1/4 x 12 1/2 x 11 3/4	38.7 x 31.7 x 28.8	1

SOUP STATION

ITEM	DESCRIPTION	CAPACITY		IN	CM	PACK
		QT	L			
AL426A	Stainless Steel	7	6.1	13 x 11	33 x 28	1
AL426GA	Gold Accented	7	6.1	13 x 11	33 x 28	1



AL426A

AL426GA



HALF SIZE CHAFER

Great for specialty and side dishes. Includes one assembled frame with die cast legs and handles, one 4" (10.2 cm) deep water pan, one 2 1/2" (6.4 cm) deep half size pan, one fuel holder, and one dome cover lid with handle.

ITEM	IN	CM	PACK
AL801A	18 x 11 3/4 x 16 1/4	45.7 x 29.8 x 41.3	1



FULL SIZE CHAFER

Perfect size for main dishes. Includes one assembled frame with die cast legs and handles, one 4 3/8" (11.1 cm) deep dripless water pan, one 2 1/2" (6.4 cm) deep full size pan, two fuel holders, and one dome cover lid with handle.

ITEM	IN	CM	PACK
AL800A	22 1/2 x 14 x 12 1/4	57.2 x 35.6 x 31.1	1



ECONOMY FULL SIZE CHAFING DISH

Economical design with welded frame and plastic handled cover.

ITEM	IN	CM	PACK
AL820A	24 x 14 x 12 1/4	61 x 35.6 x 31.1	1



FULL SIZE CHAFER WITH HINGED DOME COVER

Comes with one frame with die cast legs and handles, one 4 3/8" (11.1 cm) deep dripless water pan, one 2 1/2" (6.4 cm) deep water pan, two fuel holders, and one hinged dome cover lid.

ITEM	IN	CM	PACK
AL800HDCA	22 1/2 x 14 x 12 1/4	57.2 x 35.6 x 31.1	1

Chafers Components



SU482



SU382

CHAFER FRAMES

A variety of frames available to use interchangeably with chafing dish component parts. Frames conveniently stack for easy storage.

ITEM	DESCRIPTION	IN	CM	PACK
SU382	Half Size Frame	12 3/4 x 10 x 9 3/4	32.4 x 25.4 x 24.8	1
SU482	Full Size Frame	20 3/4 x 12 1/2 x 8 1/2	52.7 x 31.8 x 21.6	1

FUEL HOLDER

Fuel holder fits all Alegacy chafing dishes. Stainless steel with a sliding cover.

ITEM	IN	CM	PACK
AL84	3 1/2	8.9	6



HALF & FULL SIZE FOOD PANS

Both half and full size food pans can be combined and used interchangeably with various models of chafers (see pages 100-106 for other steam table pans and parts).

ITEM	DESCRIPTION	DEPTH		PACK
		IN	CM	
8002	Full Size	2 1/2	6.4	6
8004	Full Size	4	10.2	6
8122STP	Half Size	2 1/2	6.4	6
8124	Half Size	4	10.2	6





SH8843



SH8943



SH943HDC

DOMES COVERS

Covers are polished on the outside and come complete with handles. Fits standard size pans.

ITEM	CHAFER TO FIT	IN	CM	PACK
SH8843	Half Size Frame	13 x 10 5/8 x 2 3/4	33 x 27 x 7	9
SH8943	Full Size	21 1/8 x 13 x 2 3/4	53.7 x 33 x 7	9
SH943HDC	Full Size	21 1/2 x 13 x 2 3/4	54.6 x 33 x 7	3



ROLL TOP COVER

Keep food pan contents warm and protected with our 18/8 stainless steel, handled cover that rolls back for easy access to food product.

ITEM	LENGTH		WIDTH		HEIGHT		PACK
	IN	CM	IN	CM	IN	CM	
RC100	21	53.33	13 3/4	34.9	12	30.4	1



FULL SIZE WATER PAN

Stainless steel, dripless water pan prevents chafers condensation from dripping onto tables.

ITEM	DEPTH		PACK
	IN	CM	
800412WD	4 1/2	11.4	6

CHAFER COVER HOLDER

Conveniently holds chafers dome cover behind unit for easy service and access. Two clips recommended for full size chafers, one for half size.

ITEM	DEPTH		PACK
	IN	CM	
2090	5 1/4	13.3	24



CSB251512B

CHAFER STORAGE BOX

Allows for convenient storage and stacking of chafers. Available in blue or gray colors with interlocking lids.

ITEM	COLOR	LENGTH		PACK
		IN	CM	
 CSB251512B	Blue	26 1/2 x 17 x 12	67.3 x 43.2 x 30.5	1
CSB251512G	Gray	26 1/2 x 17 x 12	67.3 x 43.2 x 30.5	1

For additional serving utensils, see Plasticware chapter, page 73.

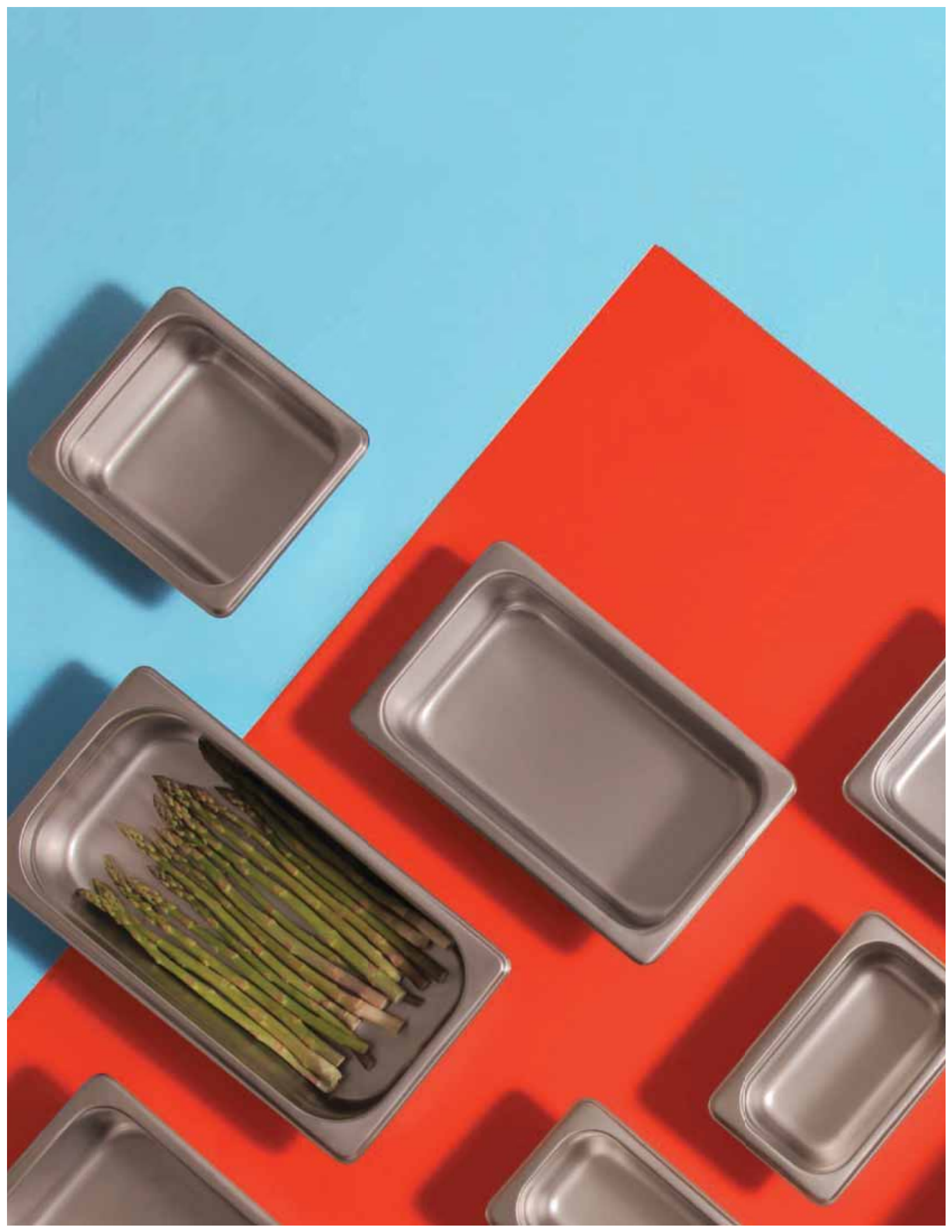

STEAM TABLE PANS & INSETS

Anti-Jamming Pans

100 - 102

Standard Pans

103

Covers & Accessories

104 - 106

Insets & Bain Maries

107



Rest-Rite™ Anti-Jamming Steam Table Pans

Alegacy's Rest-Rite steam table pans come in four advertised thicknesses so you can choose the right quality pan at the right price. They are all crafted with the full perimeter anti-jam ridge to prevent pans from jamming during shipment or storage, and also feature reinforced corners for superior shape retention. The 22 and 24 gauge 18/8 stainless steel pans are built to last while the 23 and 25 economy gauge may be just what you need at a great value. All steam table pans are NSF listed.

Anti-Jamming Steam Table Pans

Alegacy steam table pans feature anti-jamming, 22 and 24 standard gauge design, and re-engineered, stronger corners, allowing finger space between pans for quick removal. Also, the anti-jamming, reinforced corner design increases heating efficiency and lengthens safe holding times by an improved fit in the well. Also available in 23 and 25 economy gauge design.



 Economy line offerings are identified by our green e-line icon and matching color-coded chart items.



FULL SIZE STANDARD STEAM TABLE PANS

ITEM	CAPACITY		LENGTH		WIDTH		DEPTH		PACK
	QT	L	IN	CM	IN	CM	IN	CM	
22 GAUGE									
22002	8 1/2	8	20 3/4	53	12 3/4	32.4	2 1/2	6.4	6
22004	14 1/2	13.7	20 3/4	53	12 3/4	32.4	4	10	6
22006	22	20.8	20 3/4	53	12 3/4	32.4	6	15	6
24 GAUGE									
88002	8 1/2	8	20 3/4	53	12 3/4	32.4	2 1/2	6.4	6
88004	14 1/2	13.7	20 3/4	53	12 3/4	32.4	4	10	6
88006	22	20.8	20 3/4	53	12 3/4	32.4	6	15	6

FULL SIZE ECONOMY STEAM TABLE PANS



ITEM	CAPACITY		LENGTH		WIDTH		DEPTH		PACK
	QT	L	IN	CM	IN	CM	IN	CM	
23 GAUGE									
 77002	8 1/2	8	20 3/4	53	12 3/4	32.4	2 1/2	6.4	6
77004	14 1/2	13.7	20 3/4	53	12 3/4	32.4	4	10	6
77006	22	20.8	20 3/4	53	12 3/4	32.4	6	15	6
25 GAUGE									
 55002	8 1/2	8	20 3/4	53	12 3/4	32.4	2 1/2	6.4	6
55004	14 1/2	13.7	20 3/4	53	12 3/4	32.4	4	10	6
55006	22	20.8	20 3/4	53	12 3/4	32.4	6	15	6



HALF SIZE STANDARD STEAM TABLE PANS

ITEM	CAPACITY		LENGTH		WIDTH		DEPTH		PACK
	QT	L	IN	CM	IN	CM	IN	CM	
22 GAUGE									
22122STP	4 1/2	4.3	12 3/4	32.4	10 3/8	26.4	2 1/2	6.4	12
22124STP	7	6.6	12 3/4	32.4	10 3/8	26.4	4	10	6
22126	11	10.4	12 3/4	32.4	10 3/8	26.4	6	15	6
24 GAUGE									
88122	4 1/2	4.3	12 3/4	32.4	10 3/8	26.4	2 1/2	6.4	12
88124	7	6.6	12 3/4	32.4	10 3/8	26.4	4	10	6
88126	11	10.4	12 3/4	32.4	10 3/8	26.4	6	15	6

HALF SIZE ECONOMY STEAM TABLE PANS

ITEM	CAPACITY		LENGTH		WIDTH		DEPTH		PACK
	QT	L	IN	CM	IN	CM	IN	CM	
23 GAUGE									
 77122STP	4 1/2	4.3	12 3/4	32.4	10 3/8	26.4	2 1/2	6.4	12
77124STP	7	6.6	12 3/4	32.4	10 3/8	26.4	4	10	6
77126	11	10.4	12 3/4	32.4	10 3/8	26.4	6	15	6
25 GAUGE									
 55122	4 1/2	4.3	12 3/4	32.4	10 3/8	26.4	2 1/2	6.4	12
55124	7	6.6	12 3/4	32.4	10 3/8	26.4	4	10	6
55126	11	10.4	12 3/4	32.4	10 3/8	26.4	6	15	6





Rest-Rite Anti-Jamming Construction



TWO-THIRDS SIZE STANDARD STEAM TABLE PANS

ITEM	CAPACITY		LENGTH		WIDTH		DEPTH		PACK
	QT	L	IN	CM	IN	CM	IN	CM	
22 GAUGE									
22232	6 1/2	6.2	13 7/8	35.2	12 3/4	32.4	2 1/2	6.4	12
22234	9 1/2	9	13 7/8	35.2	12 3/4	32.4	4	10.2	12
22236	14 1/2	13.7	13 7/8	35.2	12 3/4	32.4	6	15.2	12
24 GAUGE									
88232	6 1/2	6.2	13 7/8	35.2	12 3/4	32.4	2 1/2	6.4	12
88234	9 1/2	9	13 7/8	35.2	12 3/4	32.4	4	10	12
88236	14 1/2	13.7	13 7/8	35.2	12 3/4	32.4	6	15	12



TWO-THIRDS SIZE ECONOMY STEAM TABLE PANS

ITEM	CAPACITY		LENGTH		WIDTH		DEPTH		PACK
	QT	L	IN	CM	IN	CM	IN	CM	
23 GAUGE									
 77232	6 1/2	6.2	13 7/8	35.2	12 3/4	32.4	2 1/2	6.4	12
77234	9 1/2	9	13 7/8	35.2	12 3/4	32.4	4	10.2	12
77236	14 1/2	13.7	13 7/8	35.2	12 3/4	32.4	6	15.2	12
25 GAUGE									
 55232	6 1/2	6.2	13 7/8	35.2	12 3/4	32.4	2 1/2	6.4	12
55234	9 1/2	9	13 7/8	35.2	12 3/4	32.4	4	10	12
55236	14 1/2	13.7	13 7/8	35.2	12 3/4	32.4	6	15	12

ONE-THIRD SIZE STANDARD STEAM TABLE PANS

ITEM	CAPACITY		LENGTH		WIDTH		DEPTH		PACK
	QT	L	IN	CM	IN	CM	IN	CM	
22 GAUGE									
22132	2 1/2	2.4	12 3/4	32.4	6 7/8	17.5	2 1/2	6.4	12
22134	4 1/2	4.3	12 3/4	32.4	6 7/8	17.5	4	10	12
22136	6 5/8	6.3	12 3/4	32.4	6 7/8	17.5	6	15	12
24 GAUGE									
88132	2 1/2	2.4	12 3/4	32.4	6 7/8	17.5	2 1/2	6.4	12
88134	4 1/2	4.3	12 3/4	32.4	6 7/8	17.5	4	10	12
88136	6 5/8	6.3	12 3/4	32.4	6 7/8	17.5	6	15	12



ONE-THIRD SIZE ECONOMY STEAM TABLE PANS

ITEM	CAPACITY		LENGTH		WIDTH		DEPTH		PACK
	QT	L	IN	CM	IN	CM	IN	CM	
23 GAUGE									
 77132	2 1/2	2.4	12 3/4	32.4	6 7/8	17.5	2 1/2	6.4	12
77134	4 1/2	4.3	12 3/4	32.4	6 7/8	17.5	4	10	12
77136	6 5/8	6.3	12 3/4	32.4	6 7/8	17.5	6	15	12
25 GAUGE									
 55132	2 1/2	2.4	12 3/4	32.4	6 7/8	17.5	2 1/2	6.4	12
55134	4 1/2	4.3	12 3/4	32.4	6 7/8	17.5	4	10	12
55136	6 5/8	6.3	12 3/4	32.4	6 7/8	17.5	6	15	12

ONE-QUARTER SIZE STANDARD STEAM TABLE PANS

ITEM	CAPACITY		LENGTH		WIDTH		DEPTH		PACK
	QT	L	IN	CM	IN	CM	IN	CM	
22 GAUGE									
22142	1 7/8	1.8	10 3/8	26.4	6 3/8	16.2	2 1/2	6.4	12
22144	3	2.8	10 3/8	26.4	6 3/8	16.2	4	10	12
22146	4 1/2	4.3	10 3/8	26.4	6 3/8	16.2	6	15	12
24 GAUGE									
88142	1 7/8	1.8	10 3/8	26.4	6 3/8	16.2	2 1/2	6.4	12
88144	3	2.8	10 3/8	26.4	6 3/8	16.2	4	10	12
88146	4 1/2	4.3	10 3/8	26.4	6 3/8	16.2	6	15	12



ONE-QUARTER SIZE ECONOMY STEAM TABLE PANS

ITEM	CAPACITY		LENGTH		WIDTH		DEPTH		PACK
	QT	L	IN	CM	IN	CM	IN	CM	
23 GAUGE									
 77142	1 7/8	1.8	10 3/8	26.4	6 3/8	16.2	2 1/2	6.4	12
77144	3	2.8	10 3/8	26.4	6 3/8	16.2	4	10	12
77146	4 1/2	4.3	10 3/8	26.4	6 3/8	16.2	6	15	12
25 GAUGE									
 55142	1 7/8	1.8	10 3/8	26.4	6 3/8	16.2	2 1/2	6.4	12
55144	3	2.8	10 3/8	26.4	6 3/8	16.2	4	10	12
55146	4 1/2	4.3	10 3/8	26.4	6 3/8	16.2	6	15	12

ONE-SIXTH SIZE STANDARD STEAM TABLE PANS

ITEM	CAPACITY		LENGTH		WIDTH		DEPTH			PACK
	QT	L	IN	CM	IN	CM	IN	CM		
22 GAUGE										
22162	1 3/8	1.3	6 7/8	17.5	6 3/8	16.2	2 1/2	6.4	12	
22164	2	1.9	6 7/8	17.5	6 3/8	16.2	4	10	12	
22166	2 3/4	2.6	6 7/8	17.5	6 3/8	16.2	6	15	12	
24 GAUGE										
88162	1 3/8	1.3	6 7/8	17.5	6 3/8	16.2	2 1/2	6.4	12	
88164	2	1.9	6 7/8	17.5	6 3/8	16.2	4	10	12	
88166	2 3/4	2.6	6 7/8	17.5	6 3/8	16.2	6	15	12	



ONE-SIXTH SIZE ECONOMY STEAM TABLE PANS

ITEM	CAPACITY		LENGTH		WIDTH		DEPTH			PACK
	QT	L	IN	CM	IN	CM	IN	CM		
23 GAUGE										
 77162	1 3/8	1.3	6 7/8	17.5	6 3/8	16.2	2 1/2	6.4	12	
77164	2	1.9	6 7/8	17.5	6 3/8	16.2	4	10	12	
77166	2 3/4	2.6	6 7/8	17.5	6 3/8	16.2	6	15	12	
25 GAUGE										
 55162	1 3/8	1.3	6 7/8	17.5	6 3/8	16.2	2 1/2	6.4	12	
55164	2	1.9	6 7/8	17.5	6 3/8	16.2	4	10	12	
55166	2 3/4	2.6	6 7/8	17.5	6 3/8	16.2	6	15	12	

ONE-NINTH SIZE STANDARD STEAM TABLE PANS

ITEM	CAPACITY		LENGTH		WIDTH		DEPTH			PACK
	QT	L	IN	CM	IN	CM	IN	CM		
22 GAUGE										
22192	5/8	.6	6 7/8	17.5	4 1/4	10.8	2 1/2	6.4	12	
22194	1 1/8	1.1	6 7/8	17.5	4 1/4	10.8	4	10	12	
24 GAUGE										
88192	5/8	.6	6 7/8	17.5	4 1/4	10.8	2 1/2	6.4	12	
88194	1 1/8	1.1	6 7/8	17.5	4 1/4	10.8	4	10	12	

ONE-NINTH SIZE ECONOMY STEAM TABLE PANS

ITEM	CAPACITY		LENGTH		WIDTH		DEPTH			PACK
	QT	L	IN	CM	IN	CM	IN	CM		
23 GAUGE										
 77192	5/8	.6	6 7/8	17.5	4 1/4	10.8	2 1/2	6.4	12	
77194	1 1/8	1.1	6 7/8	17.5	4 1/4	10.8	4	10	12	
25 GAUGE										
 55192	5/8	.6	6 7/8	17.5	4 1/4	10.8	2 1/2	6.4	12	
55194	1 1/8	1.1	6 7/8	17.5	4 1/4	10.8	4	10	12	



Economy line offerings are identified by our green e-line icon and matching color-coded chart items.

HALF LONG S/S COVER

ITEM	FITS PAN	IN	CM	PACK
CP2224L	Half Long Pans	20 7/8 x 6 3/8	53 x 16.2	12



KNOCK BOX

Stainless steel utility knock box meets every coffee need.

ITEM	LENGTH		WIDTH		DEPTH		
	IN	CM	IN	CM	IN	CM	PACK
CKB10	6 7/8	17.5	6 3/8	16.2	6	15	6



HALF LONG S/S PANS

ITEM	CAPACITY		LENGTH		WIDTH		DEPTH		
	QT	L	IN	CM	IN	CM	IN	CM	
22241L	2	2.4	20 7/8	53	6 3/8	16.2	1 1/2	3.8	12
22242L	4 1/4	4	20 7/8	53	6 3/8	16.2	2 1/2	6.4	12
22244L	6 1/3	6	20 7/8	53	6 3/8	16.2	4	10.2	6
22246L	9 1/2	9	20 7/8	53	6 3/8	16.2	6	15.2	6

Steam Table Pans

These 18/8 stainless steel steam table pans are tight-fitting, so steam can't escape, lengthening safe holding times. Their reinforced edges prevent the corners from bending, they fit better in the well, and can easily be moved from freezer to oven without re-panning. Available in 22 and 24 gauge stainless steel. A variety of accessories and covers are also available. Alegacy steam table pans are NSF listed.



FULL SIZE STEAM TABLE PANS

ITEM	CAPACITY		LENGTH		WIDTH		DEPTH		PACK
	QT	L	IN	CM	IN	CM	IN	CM	
22 GAUGE									
2002STP	8 1/2	8	20 3/4	53	12 3/4	32.4	2 1/2	6.4	6
2004STP	14 1/2	13.7	20 3/4	53	12 3/4	32.4	4	10	6
2006	22	20.8	20 3/4	53	12 3/4	32.4	6	15	6
24 GAUGE									
8002	8 1/2	8	20 3/4	53	12 3/4	32.4	2 1/2	6.4	6
8004	14 1/2	13.7	20 3/4	53	12 3/4	32.4	4	10	6
8006	22	20.8	20 3/4	53	12 3/4	32.4	6	15	6

HALF SIZE STEAM TABLE PANS

ITEM	CAPACITY		LENGTH		WIDTH		DEPTH		PACK
	QT	L	IN	CM	IN	CM	IN	CM	
22 GAUGE									
2122	4 1/2	4.3	12 3/4	32.4	10 3/8	26.4	2 1/2	6.4	6
2124	7	6.6	12 3/4	32.4	10 3/8	26.4	4	10	6
2126	11	10.4	12 3/4	32.4	10 3/8	26.4	6	15	6
24 GAUGE									
8122STP	4 1/2	4.3	12 3/4	32.4	10 3/8	26.4	2 1/2	6.4	12
8124	7	6.6	12 3/4	32.4	10 3/8	26.4	4	10	6
8126	11	10.4	12 3/4	32.4	10 3/8	26.4	6	15	6

TWO-THIRDS SIZE STEAM TABLE PANS

ITEM	CAPACITY		LENGTH		WIDTH		DEPTH		PACK
	QT	L	IN	CM	IN	CM	IN	CM	
24 GAUGE									
8232	6 1/2	6.2	13 7/8	35.2	12 3/4	32.4	2 1/2	6.4	12
8234	9 1/2	9	13 7/8	35.2	12 3/4	32.4	4	10	12
8236	14 1/2	13.7	13 7/8	35.2	12 3/4	32.4	6	15	6

ONE-THIRD SIZE STEAM TABLE PANS

ITEM	CAPACITY		LENGTH		WIDTH		DEPTH		PACK
	QT	L	IN	CM	IN	CM	IN	CM	
22 GAUGE									
2132	2 1/2	2.4	12 3/4	32.4	6 7/8	17.5	2 1/2	6.4	12
2134	4 1/2	4.3	12 3/4	32.4	6 7/8	17.5	4	10	12
2136	6 5/8	6.3	12 3/4	32.4	6 7/8	17.5	6	15	12
24 GAUGE									
8132	2 1/2	2.4	12 3/4	32.4	6 7/8	17.5	2 1/2	6.4	12
8134	4 1/2	4.3	12 3/4	32.4	6 7/8	17.5	4	10	12
8136	6 5/8	6.3	12 3/4	32.4	6 7/8	17.5	6	15	12

ONE-QUARTER SIZE STEAM TABLE PANS

ITEM	CAPACITY		LENGTH		WIDTH		DEPTH		PACK
	QT	L	IN	CM	IN	CM	IN	CM	
22 GAUGE									
2142	1 7/8	1.8	10 3/8	26.4	6 3/8	16.2	2 1/2	6.4	12
2144	3	2.8	10 3/8	26.4	6 3/8	16.2	4	10	12
2146	4 1/2	4.3	10 3/8	26.4	6 3/8	16.2	6	15	12
24 GAUGE									
8142	1 7/8	1.8	10 3/8	26.4	6 3/8	16.2	2 1/2	6.4	12
8144	3	2.8	10 3/8	26.4	6 3/8	16.2	4	10	12
8146	4 1/2	4.3	10 3/8	26.4	6 3/8	16.2	6	15	12

ONE-SIXTH SIZE STEAM TABLE PANS

ITEM	CAPACITY		LENGTH		WIDTH		DEPTH		PACK
	QT	L	IN	CM	IN	CM	IN	CM	
22 GAUGE									
2162	1 3/8	1.3	6 7/8	17.5	6 3/8	16.2	2 1/2	6.4	12
2164	2	1.9	6 7/8	17.5	6 3/8	16.2	4	10	12
2166	2 3/4	2.6	6 7/8	17.5	6 3/8	16.2	6	15	12
24 GAUGE									
8162	1 3/8	1.3	6 7/8	17.5	6 3/8	16.2	2 1/2	6.4	12
8164	2	1.9	6 7/8	17.5	6 3/8	16.2	4	10	12
8166	2 3/4	2.6	6 7/8	17.5	6 3/8	16.2	6	15	12

ONE-NINTH SIZE STEAM TABLE PANS

ITEM	CAPACITY		LENGTH		WIDTH		DEPTH		PACK
	QT	L	IN	CM	IN	CM	IN	CM	
24 GAUGE									
8192	5/8	.6	6 7/8	17.5	4 1/4	10.8	2 1/2	6.4	12
8194	1 1/8	1.1	6 7/8	17.5	4 1/4	10.8	4	10	12



Economy line offerings are identified by our green e-line icon and matching color-coded chart items.

24 GAUGE STANDARD COVERS FOR STEAM TABLE PANS

Flat, solid steam table pan covers of medium weight, 24 gauge 18/8 stainless steel.

ITEM	FITS PAN	IN	CM	PACK
CP8002	Full Size	21 x 12 ⁷ / ₈	53.3 x 33	12
CP8122	Half Size	12 ³ / ₄ x 10 ⁷ / ₁₆	32.4 x 26.5	12
CP8132	One-Third Size	12 ³ / ₄ x 7	32.4 x 17.8	12
CP8142	One-Fourth Size	10 ⁷ / ₁₆ x 6 ⁷ / ₁₆	26.5 x 16.3	12
CP8162	One-Sixth Size	7 x 6 ⁷ / ₁₆	17.8 x 16.3	12
CP8192	One-Ninth Size	6 ¹⁵ / ₁₆ x 4 ³ / ₈	17.6 x 11.1	12
CP8232	Two-Thirds Size	13 ⁷ / ₈ x 12 ⁷ / ₁₆	35.2 x 32.7	12

NOTCHED COVERS

CP8002NC	Full Size	21 x 12 ⁷ / ₈	53.3 x 33	12
CP8122NC	Half Size	12 ³ / ₄ x 10 ⁷ / ₁₆	32.4 x 26.5	12
CP8132NC	One-Third Size	12 ³ / ₄ x 7	32.4 x 17.8	12
CP8142NC	One-Fourth Size	10 ⁷ / ₁₆ x 6 ⁷ / ₁₆	26.5 x 16.3	12
CP8162NC	One-Sixth Size	7 x 6 ⁷ / ₁₆	17.8 x 16.3	12
CP8192NC	One-Ninth Size	6 ¹⁵ / ₁₆ x 4 ³ / ₈	17.6 x 11.1	12
CP8232NC	Two-Thirds Size	13 ⁷ / ₈ x 12 ⁷ / ₁₆	35.2 x 32.7	12

25 GAUGE ECONOMY COVERS FOR STEAM TABLE PANS

Flat, solid steam table pan covers of medium weight, 25 gauge 18/8 stainless steel.

ITEM	FITS PAN	IN	CM	PACK
 CP5002	Full Size	21 x 12 ⁷ / ₈	53.3 x 33	12
CP5122	Half Size	12 ³ / ₄ x 10 ⁷ / ₁₆	32.4 x 26.5	12
CP5132	One-Third Size	12 ³ / ₄ x 7	32.4 x 17.8	12
CP5142	One-Fourth Size	10 ⁷ / ₁₆ x 6 ⁷ / ₁₆	26.5 x 16.3	12
CP5162	One-Sixth Size	7 x 6 ⁷ / ₁₆	17.8 x 16.3	12
CP5192	One-Ninth Size	6 ¹⁵ / ₁₆ x 4 ³ / ₈	17.6 x 11.1	12
CP5232	Two-Thirds Size	13 ⁷ / ₈ x 12 ⁷ / ₁₆	35.2 x 32.7	12

NOTCHED COVERS

 CP5002NC	Full Size	21 x 12 ⁷ / ₈	53.3 x 33	12
CP5122NC	Half Size	12 ³ / ₄ x 10 ⁷ / ₁₆	32.4 x 26.5	12
CP5132NC	One-Third Size	12 ³ / ₄ x 7	32.4 x 17.8	12
CP5142NC	One-Fourth Size	10 ⁷ / ₁₆ x 6 ⁷ / ₁₆	26.5 x 16.3	12
CP5162NC	One-Sixth Size	7 x 6 ⁷ / ₁₆	17.8 x 16.3	12
CP5192NC	One-Ninth Size	6 ¹⁵ / ₁₆ x 4 ³ / ₈	17.6 x 11.1	12
CP5232NC	Two-Thirds Size	13 ⁷ / ₈ x 12 ⁷ / ₁₆	35.2 x 32.7	12

22 GAUGE STANDARD COVERS FOR STEAM TABLE PANS

ITEM	FITS PAN	IN	CM	PACK
CP2002	Full Size	21 x 12 ⁷ / ₈	53.3 x 33	12
CP2122	Half Size	12 ³ / ₄ x 10 ⁷ / ₁₆	32.4 x 26.5	12
CP2132	One-Third Size	12 ³ / ₄ x 7	32.4 x 17.8	12
CP2142	One-Fourth Size	10 ⁷ / ₁₆ x 6 ⁷ / ₁₆	26.5 x 16.3	12
CP2162	One-Sixth Size	7 x 6 ⁷ / ₁₆	17.8 x 16.3	12

NOTCHED COVERS

CP2002NC	Full Size	21 x 12 ⁷ / ₈	53.3 x 33	12
CP2122NC	Half Size	12 ³ / ₄ x 10 ⁷ / ₁₆	32.4 x 26.5	12
CP2132NC	One-Third Size	12 ³ / ₄ x 7	32.4 x 17.8	12
CP2142NC	One-Fourth Size	10 ⁷ / ₁₆ x 6 ⁷ / ₁₆	26.5 x 16.3	12
CP2162NC	One-Sixth Size	7 x 6 ⁷ / ₁₆	17.8 x 16.3	12

23 GAUGE ECONOMY COVERS FOR STEAM TABLE PANS

ITEM	FITS PAN	IN	CM	PACK
 CP7002	Full Size	21 x 12 ⁷ / ₈	53.3 x 33	12
CP7122	Half Size	12 ³ / ₄ x 10 ⁷ / ₁₆	32.4 x 26.5	12
CP7132	One-Third Size	12 ³ / ₄ x 7	32.4 x 17.8	12
CP7142	One-Fourth Size	10 ⁷ / ₁₆ x 6 ⁷ / ₁₆	26.5 x 16.3	12
CP7162	One-Sixth Size	7 x 6 ⁷ / ₁₆	17.8 x 16.3	12

NOTCHED COVERS

 CP7002NC	Full Size	21 x 12 ⁷ / ₈	53.3 x 33	12
CP7122NC	Half Size	12 ³ / ₄ x 10 ⁷ / ₁₆	32.4 x 26.5	12
CP7132NC	One-Third Size	12 ³ / ₄ x 7	32.4 x 17.8	12
CP7142NC	One-Fourth Size	10 ⁷ / ₁₆ x 6 ⁷ / ₁₆	26.5 x 16.3	12
CP7162NC	One-Sixth Size	7 x 6 ⁷ / ₁₆	17.8 x 16.3	12



24 GAUGE STEAM TABLE PANS

Specialty shallow sizes to meet every need.

ITEM	CAPACITY		LENGTH		WIDTH		DEPTH		PACK
	QT	L	IN	CM	IN	CM	IN	CM	
8001	4 1/4	4	20 3/4	52.7	12 3/4	32	1 1/4	3.2	6
8121	2 1/10	2	12 5/8	32.1	10 3/8	26.4	1 1/4	3.2	6



STAINLESS STEEL ADAPTER BAR

Available in three sizes to aid in serving and division of steam table pans.

ITEM	LENGTH		HEIGHT		DEPTH		PACK
	IN	CM	IN	CM	IN	CM	
2087	6 3/4	17.1	5/8	1.6	1	2.5	1
2088	12 5/8	32.1	1/2	1.3	13/16	2.1	1
2089	20 1/4	51.4	3/4	1.9	1 1/8	2.9	1

 Economy line offerings are identified by our green e-line icon and matching color-coded chart items.



FALSE BOTTOM

Holds foods above pan bottom for draining or maintaining food quality of items that should not stand in liquids or juices. Finger holes allow easy removal of the insert.



ITEM	LENGTH		HEIGHT		DEPTH		PACK
	IN	CM	IN	CM	IN	CM	
FB810	10 3/4	27.3	8 3/8	21.3	9/16	1.4	40
FB917	17	43.2	9	22.9	9/16	1.4	20



STANDARD PERFORATED ANTI-JAM PAN

ITEM	CAPACITY		LENGTH		WIDTH		DEPTH		PACK
	QT	L	IN	CM	IN	CM	IN	CM	
22 GAUGE									
22002P	8 1/2	8	20 3/4	52.7	12 3/4	32.4	2 1/2	6.4	6
22004P	14 1/2	13.7	20 3/4	52.7	12 3/4	32.4	4	10.2	6
22006P	22	20.8	20 3/4	52.7	12 3/4	32.4	6	15.2	6
22122P	4 1/2	4.3	12 3/4	32.4	10 3/8	26.4	2 1/2	6.4	12
22124P	7	17.8	12 3/4	32.4	10 3/8	26.4	4	10.2	6
22126P	11	27.9	12 3/4	32.4	10 3/8	26.4	6	15.2	6
24 GAUGE									
88002P	8 1/2	8	20 3/4	52.7	12 3/4	32.4	2 1/2	6.4	6
88004P	14 1/2	13.7	20 3/4	52.7	12 3/4	32.4	4	10.2	6
88006P	22	20.8	20 3/4	52.7	12 3/4	32.4	6	15.2	6
88122P	4 1/2	4.3	12 3/4	32.4	10 3/8	26.4	2 1/2	6.4	12
88124P	7	17.8	12 3/4	32.4	10 3/8	26.4	4	10.2	6
88126P	11	27.9	12 3/4	32.4	10 3/8	26.4	6	15.2	6

ECONOMY PERFORATED ANTI-JAM PAN

ITEM	CAPACITY		LENGTH		WIDTH		DEPTH		PACK
	QT	L	IN	CM	IN	CM	IN	CM	
23 GAUGE									
 77002P	8 1/2	8	20 3/4	52.7	12 3/4	32.4	2 1/2	6.4	6
77004P	14 1/2	13.7	20 3/4	52.7	12 3/4	32.4	4	10.2	6
77006P	22	20.8	20 3/4	52.7	12 3/4	32.4	6	15.2	6
77122P	4 1/2	4.3	12 3/4	32.4	10 3/8	26.4	2 1/2	6.4	12
77124P	7	17.8	12 3/4	32.4	10 3/8	26.4	4	10.2	6
77126P	11	27.9	12 3/4	32.4	10 3/8	26.4	6	15.2	6
25 GAUGE									
 55002P	8 1/2	8	20 3/4	52.7	12 3/4	32.4	2 1/2	6.4	6
55004P	14 1/2	13.7	20 3/4	52.7	12 3/4	32.4	4	10.2	6
55006P	22	20.8	20 3/4	52.7	12 3/4	32.4	6	15.2	6
55122P	4 1/2	4.3	12 3/4	32.4	10 3/8	26.4	2 1/2	6.4	12
55124P	7	17.8	12 3/4	32.4	10 3/8	26.4	4	10.2	6
55126P	11	27.9	12 3/4	32.4	10 3/8	26.4	6	15.2	6



FULL SIZE DIVIDED PAN

Divided pan fits in full size pan opening, serving two dishes instead of one, with no adapter bars needed. Medium weight, 24 gauge 18/8 stainless steel. Capacity of each well is 3 1/2 qt (3.3 L).

ITEM	LENGTH		WIDTH		DEPTH		PACK
	IN	CM	IN	CM	IN	CM	
8002DV	20 3/4	52.7	12 3/4	32.4	2 1/2	6.4	6

PERFORATED STEAM TABLE PANS

Ideal for steaming and draining. The medium weight, 24 gauge 18/8 stainless steel pans are available in full or half sizes.



ITEM	CAPACITY		LENGTH		WIDTH		DEPTH		PACK
	QT	L	IN	CM	IN	CM	IN	CM	
FULL SIZE									
8002P	8 1/2	8	20 3/4	52.7	12 3/4	32.4	2 1/2	6.4	6
8004P	14 1/2	13.7	20 3/4	52.7	12 3/4	32.4	4	10	6
8006P	22	20.8	20 3/4	52.7	12 3/4	32.4	6	15	6
HALF SIZE									
8122P	4 1/2	4.3	12 3/4	32.4	10 3/8	26.4	2 1/2	6.4	12
8124P	7	6.6	12 3/4	32.4	10 3/8	26.4	4	10	6
8126P	11	10.4	12 3/4	32.4	10 3/8	26.4	6	15	6



SPILLAGE PAN

For use in hot well or steam tables when a separate water pan is needed. Accepts standard size pans and can also be used for bulk storage of wet or dry food products. Made of stainless steel.

ITEM	LENGTH		WIDTH		DEPTH		PACK
	IN	CM	IN	CM	IN	CM	
SP8006	21	53.3	12 7/8	32.7	6	15.2	6

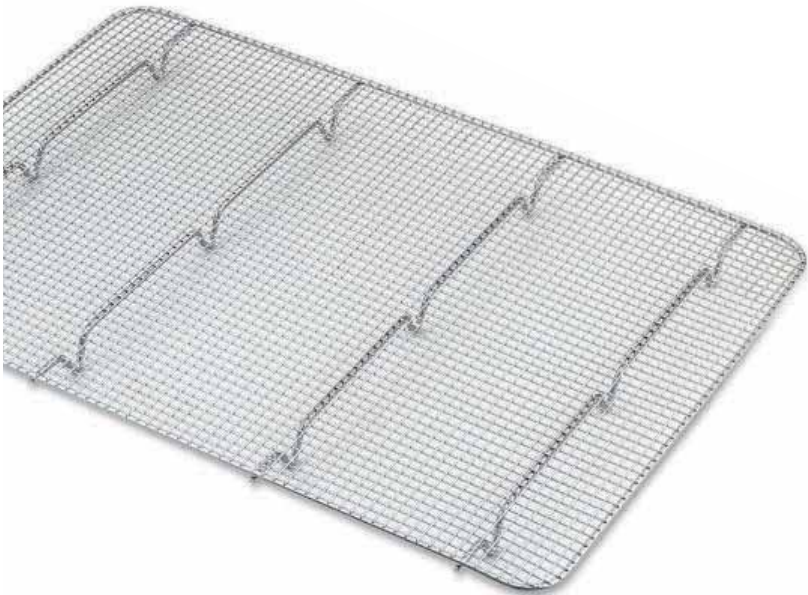

FOOTED PAN GRATES

Chrome-plated and highly polished grates keep food from sticking to the bottom of the pan. Raised grates also serve as a drain for items that should not stand in liquid or juices. Available in four sizes.

ITEM	LENGTH		WIDTH		HEIGHT		PACK
	IN	CM	IN	CM	IN	CM	
PG510	10	25.4	5	12.7	7/8	2.2	1
PG810	10	25.4	8	20.3	7/8	2.2	1
PG1018	18	45.7	10	25.4	7/8	2.2	1
PG1826	24 1/2	62.2	16 1/2	41.9	1	2.5	1



ROLL TOP COVER

Keep food pan contents warm and protected with our 18/8 stainless steel, handled cover that rolls back for easy access to food product.

ITEM	LENGTH		WIDTH		HEIGHT		PACK
	IN	CM	IN	CM	IN	CM	
RC100	21	53.3	13 3/4	34.9	12	30.4	1



VEGETABLE INSETS

Mirror polished exterior, satin finish interior, and versatility too. Can be used in round steam tables or soup warmers. Stacking covers available.

ITEM	CAPACITY		FITS OPENING		SHOULDER DIAMETER		DEPTH		COVER TO FIT	INSET PACK	COVER PACK
	QT	L	IN	CM	IN	CM	IN	CM			
VI05	2 3/8	2.2	5	12.5	7/8	2.2	5 3/8	14	VIC05	6	6
VI0612	4 1/8	3.9	6 1/2	16.5	7/8	2.2	7 1/2	18.1	VIC0612	6	6
VI0812	7 1/8	6.7	8 1/2	21.5	7/8	2.2	9 1/2	24.1	VIC0812	6	6
VI01012	11	10.4	10 1/2	26.5	1 1/4	3.2	11 3/8	28.9	VIC01012	6	6



BAIN MARIE POTS

The most versatile food storage and serving containers available. Take them from storage, to the stove top and off to the serving line, eliminating additional container use. Mirror polished exterior and satin finish interior add beauty to the list of practical benefits. Stacking covers are available.

ITEM	CAPACITY		FITS OPENING		SHOULDER DIAMETER		DEPTH		COVER TO FIT	POT PACK	COVER PACK
	QT	L	IN	CM	IN	CM	IN	CM			
BMP1	1 1/4	1.2	4 1/8	10.5	6 1/2	14.6	4 3/4	12	CBMP1	6	12
BMP2	2	1.9	4 7/8	12.4	6 3/4	17.1	5 1/2	14	CBMP2	6	12
BMP3	3 1/2	3.3	6 1/8	15.6	7 1/4	18.4	6 3/4	17.5	CBMP3	6	12
BMP4	4 1/4	4	6 5/8	16.8	7 1/2	19.4	7 1/8	18	CBMP4	6	12
BMP6	6	5.7	7 1/4	18.4	8 3/4	21.9	8	20	CBMP6	6	12
BMP8	8 1/4	7.8	8	20.3	9 3/4	25	8 3/4	22	CBMP8	6	12
BMP12	12	11.4	9 1/4	23.5	9 15/16	25.2	10 5/8	27	CBMP12	6	12

SOUP LADLES

Ideal handle design for hanging inside vegetable insets or bain marie pots.

ITEM	CAPACITY		HANDLE LENGTH		PACK
	OZ	ML	IN	CM	
9944L	4	118.3	13	33	12
9946L	6	177.9	14	35.6	12
9948L	8	236.5	14	35.6	12



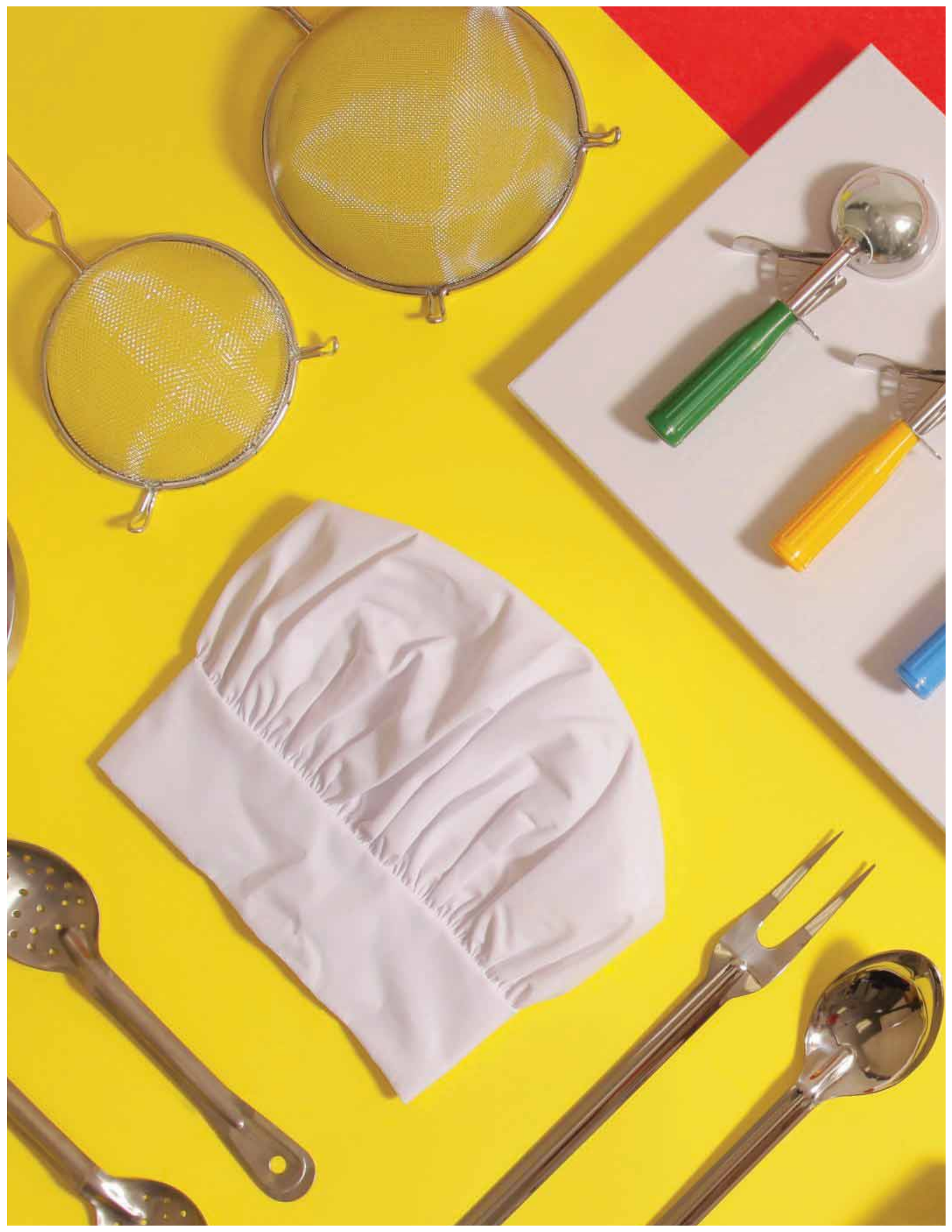

KITCHEN UTENSILS

Strainers & Skimmers

110 - 113

Colanders & Bowls

114 - 116

Spoons & Ladles

117 - 123

Can Openers

124 - 125

Ice Cream Dishers

126 - 129

Scoops

130 - 131

Whips

131 - 132

Tongs

134 - 135

Small Utensils

136 - 142

Timers

143

Cleaning Items

143

Oven Mitts & Aprons

144 - 145

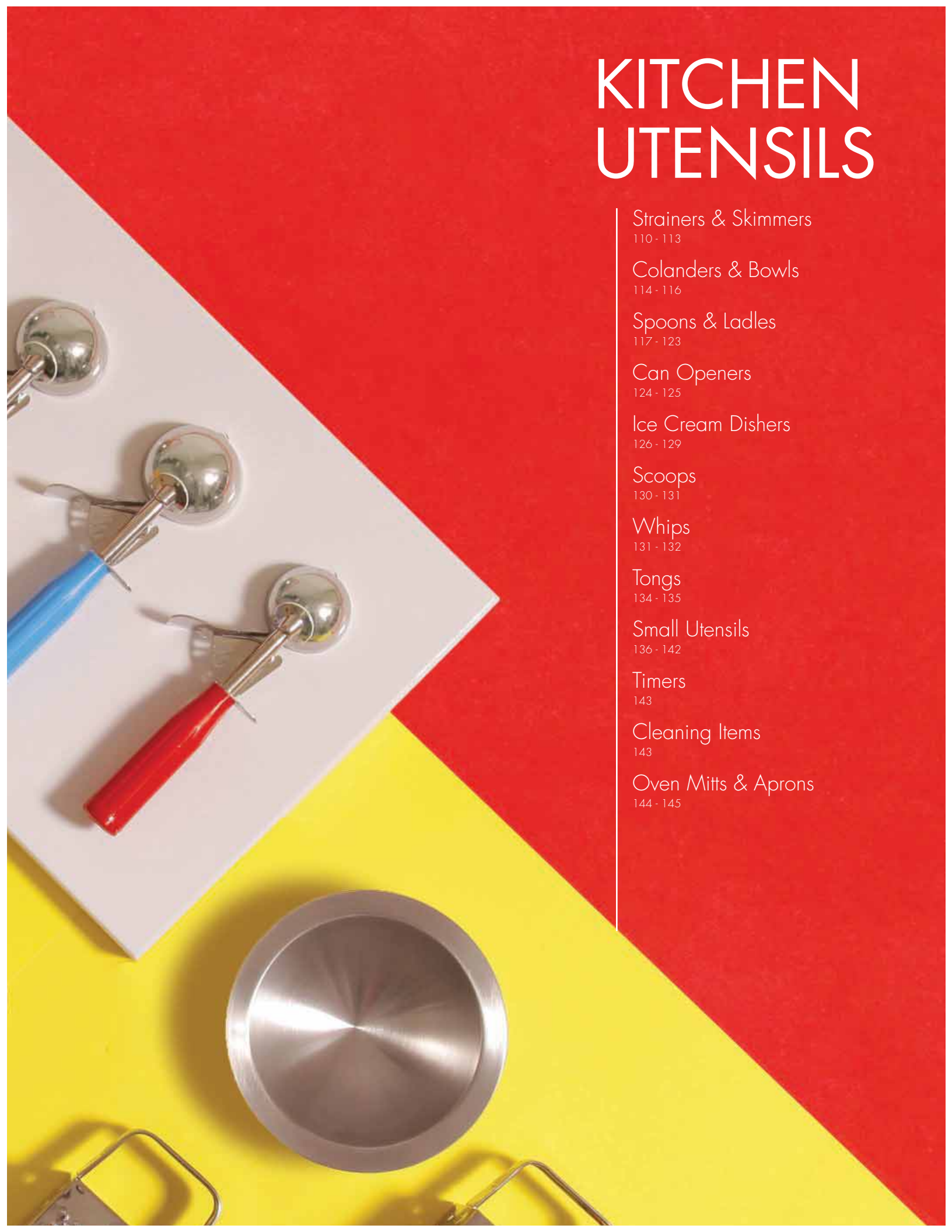

Strainers

Strainers get tossed around more than any other utensils in the kitchen. With this in mind, our quality Italian-made designs are built to withstand the abuse and survive for years, which means savings for you in the long run. Alegacy's strainers are made with metal wire mesh, reinforced wire rims, and double fire tin dipped for the highest level of corrosion protection. Flat handles and pan hooks make these strainers practical and easy to use, and a great value in every commercial kitchen.



9091

STRAINER – SINGLE MESH

The pan hook and flat-bottom handle balance the strainer over a pan for hands-free operation. They are full bath tinned after fabrication, plus clear lacquered handles. Available in fine or medium mesh.

FINE MESH ITEM	MEDIUM MESH ITEM	BOWL SIZE		HANDLE LENGTH		PACK
		IN	CM	IN	CM	
9091		2 3/4	7	4	10.2	12
9092		4	10.2	5 1/2	14	12
9093	9193	4 3/4	12.1	5 1/4	13.3	12
9094	9194	5 1/2	14	6 1/2	16.5	12
9095	9195	6 1/4	15.8	6 3/8	16.2	12
9096	9196	7 1/4	18.4	6 3/8	16.2	12
9098	9198	8	20.3	6 1/4	15.9	12
9099	9199	10 1/4	26	9	22.9	12



STRAINER - DOUBLE MESH

Includes pan hooks and a flat-bottom handle, enabling hands-free use. Re-tinned with lacquered wood handles and outer reinforcing mesh. Available in fine or medium mesh.

FINE MESH ITEM	MEDIUM MESH ITEM	BOWL SIZE		HANDLE LENGTH		PACK
		IN	CM	IN	CM	
8095	8195	6 1/4	15.9	6	15.2	12
8098	8198	8	20.3	6 1/2	16.5	12
8099	8199	10 1/4	26	9	22.9	12



SPLATTER SCREEN

Ideal for containing grease splatter when frying or cooking.

ITEM	DIAMETER		HANDLE LENGTH		PACK
	IN	CM	IN	CM	
SS8	8 5/16	21.1	5 1/4	13.3	12



HEAVY-DUTY STRAINER

Rigid double mesh with reinforcing bands and a heavy wooden handle make this durable strainer perfect for large jobs. The medium mesh is full bath tinned after fabrication.

ITEM	BOWL SIZE		HANDLE LENGTH		PACK
	IN	CM	IN	CM	
9100	9	22.9	9	22.9	6
9150	10 1/4	26	9	22.9	6
9200	12	30.5	17	43.2	6
9250	14	35.6	17	43.2	6



STAINLESS STEEL SINGLE MESH STRAINER

Double pan hooks and flat-bottom handles.

Easy-to-clean stainless steel.



ITEM	MESH	BOWL SIZE		O/A LENGTH		PACK
		IN	CM	IN	CM	
 S9093	Fine	4 3/4	12.1	5 1/4	13.3	12
S9193	Medium	4 3/4	12.1	5 1/4	13.3	12
S9095	Fine	6 1/4	15.9	13	33	12
S9195	Medium	6 1/4	15.9	12 1/2	31.8	12
S9098	Fine	8	20.3	14 1/2	36.8	12
S9198	Medium	8	20.3	14	35.6	12
S9099	Fine	10 1/4	26	21 1/2	54.6	12
S9199	Medium	10 1/4	26	21	53.3	12



All items on this page are part of our economy line offerings, identified by our green e-line icon and matching color-coded chart items.

STAINLESS STEEL DOUBLE MESH STRAINER

Sturdier mesh and rim construction. Easy-to-clean stainless steel.



ITEM	MESH	BOWL SIZE		O/A LENGTH		PACK
		IN	CM	IN	CM	
 S8095	Fine	6 1/4	15.9	12 1/2	31.8	12
S8195	Medium	6 1/4	15.9	12 1/2	31.8	12
S8098	Fine	8	20.3	14	35.6	12
S8198	Medium	8	20.3	14 1/2	36.8	12
S8099	Fine	10 1/4	26	21	53.3	12
S8199	Medium	10 1/4	26	21	53.3	12

NOODLE STRAINER

Deep cylindrical bowl, perfect for use with noodles and pastas.

ITEM	BOWL DIAMETER		LENGTH		PACK
	IN	CM	IN	CM	
 NS56	5	12.7	9	22.9	12



S9250

S9150

HEAVY-DUTY STAINLESS STEEL STRAINER

Rigid double mesh with reinforcing bands and a heavy wooden handle make this durable strainer perfect for large jobs where maximum corrosion resistance is needed.

ITEM	BOWL SIZE		HANDLE LENGTH		PACK
	IN	CM	IN	CM	
 S9100	9	22.9	9	22.9	6
S9150	10 1/4	26	9	22.9	6
S9200	12	30.5	17	43.2	6
S9250	14	35.6	17	43.2	6

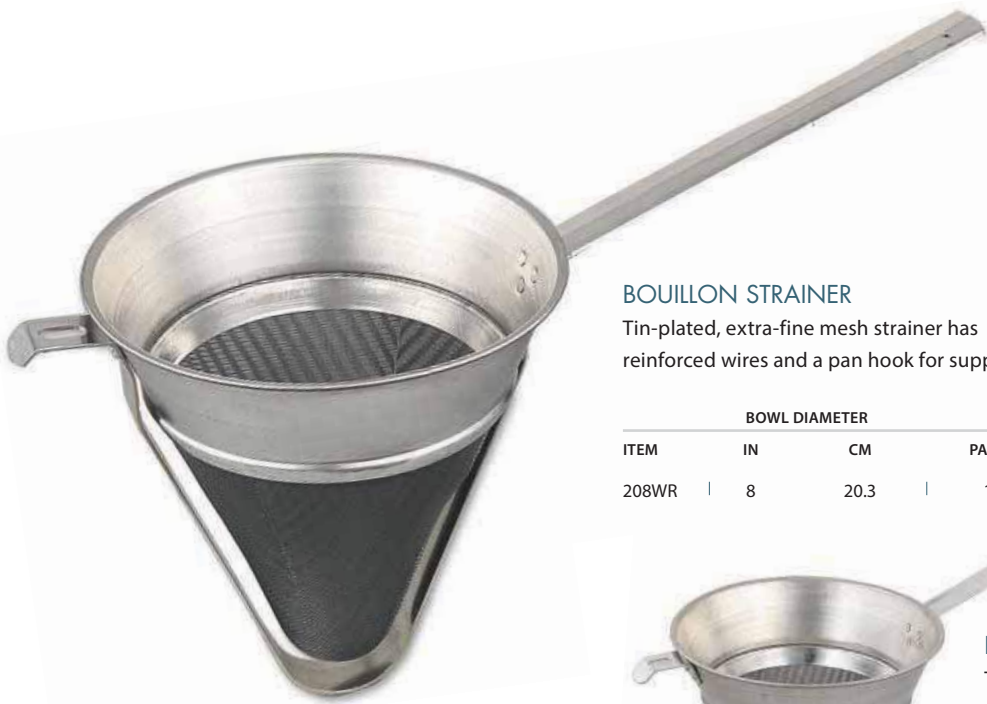

BOUILLON STRAINER

Tin-plated, extra-fine mesh strainer has reinforced wires and a pan hook for support.

ITEM	BOWL DIAMETER		PACK
	IN	CM	
208WR	8	20.3	1



BOUILLON STRAINER

Tin-plated with extra-fine mesh. Pan hook provides stability while straining liquids.

ITEM	BOWL DIAMETER		PACK
	IN	CM	
20P	8	20.3	1

ECONOMY BOUILLON STRAINERS

ITEM	BOWL DIAMETER		PACK
	IN	CM	
 20PE	8	20.3	1
208WRE	8	20.3	1
210PE	10 1/4	26	1
210WRE	10 1/4	26	1



 Economy line offerings are identified by our green e-line icon and matching color-coded chart items.

FINE OR COARSE CHINA CAPS

Sturdy 18/8 stainless steel with a perforated metal body. One-piece handle is made to rest solidly on the rim of the pan or comfortably in your hands. The grooved design adds to the strength, while the frame-style handle dissipates heat. Available in fine or coarse model.



FINE CHINA CAPS ITEM	COARSE CHINA CAPS ITEM	BOWL DIAMETER		PACK
		IN	CM	
S507F	S507C	7	17.8	1
S508F	S508C	8 1/2	21.6	1
S509F	S509C	9	22.8	1
S5010F	S5010C	10 1/2	26.7	1
S5012F	S5012C	12 1/2	31.8	1



SKIMMER

The long, hooked handle displaces heat and will allow a greater reach. Skimmer is nickel-plated with spiral wire. Removes particles from stock pots or fryers.

ITEM	BOWL DIAMETER		PACK
	IN	CM	
1305	5	12.7	12
1306	6	15.2	12
1307	7	17.8	12
1308MS	8	20.3	12
1309	9	22.9	12

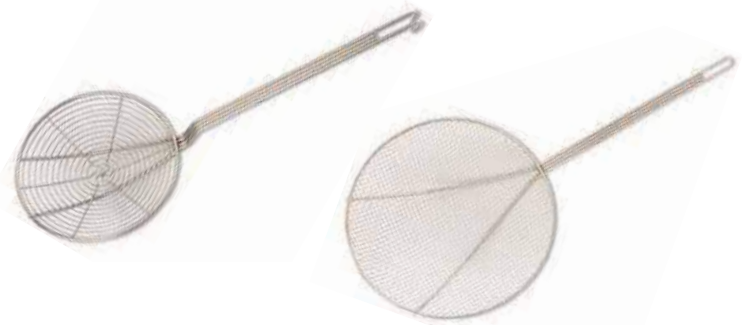

SKIMMER

The rigid, long, hooked handle is a low heat transferring design. Nickel-plated with square mesh.

ITEM	BOWL DIAMETER		PACK
	IN	CM	
1305T	5	12.7	12
1306T	6	15.2	12
1307T	7	17.8	12
1308T	8	20.3	12
1309T	9	22.9	12
1312T	12	30.5	12



HEAVY-DUTY SKIMMER

Handle the toughest kitchen applications with our one-piece satin polished stainless steel skimmers. The long, hooked handle serves as a pot rest.

ITEM	BOWL DIAMETER		PACK
	IN	CM	
374HD	4	10.2	12
375HD	4 3/4	12	12
376HD	6 1/4	15.9	12

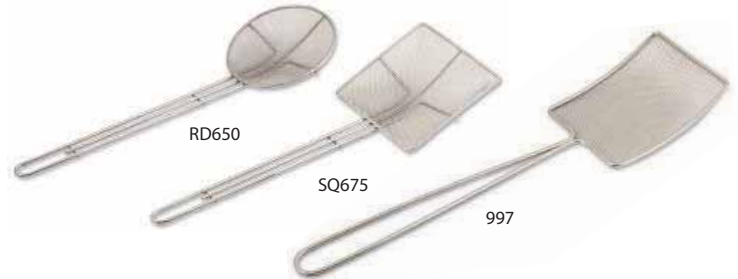

STAINLESS STEEL SKIMMER

Brightly polished stainless steel skimmer is easy to clean. Long, hooked handle serves as a pot rest.

ITEM	BOWL DIAMETER		PACK
	IN	CM	
374SK	4 1/2	11.4	12
375	6	15.2	12

FINE MESH SKIMMER

One-piece handle is low-heat transferring. The fine wire mesh is available in round or square models.

ITEM	DESCRIPTION	BOWL DIMENSIONS		PACK
		IN	CM	
RD650	Round Reinforced	6 1/2	16.5	12
SQ675	Square Reinforced	6 1/2 x 6 1/2	16.5 x 16.5	12
997	Square	5 x 6	12.7 x 15.2	12



DOUBLE MESH SKIMMER

Fine, re-tinned mesh with a 17 1/2" (44.5 cm) handle.

ITEM	BOWL DIAMETER		PACK
	IN	CM	
DMS6	6	15.2	12
DMS8	8	20.3	12
DMS9	9	22.9	12

HEAVY-DUTY ALUMINUM COLANDER

The heavier weight of this colander handles more like a pot: strong, solid, and durable. With the stand-alone base the colander can be placed over the drain for a hands-free rinsing. Riveted handles and rounded edges make this even stronger. Both colanders have 3/16" holes.



ITEM	CAPACITY		DIAMETER		DEPTH		PACK
	QT	L	IN	CM	IN	CM	
CA1611	11	10.4	15	38.1	5 3/4	14.6	2
CA1616	16	15.1	16 1/2	41.9	6 3/8	16.2	2



ECONOMY ALUMINUM COLANDER

These lightweight colanders feature a stand-alone base for hands-free draining and are easy to handle, particularly when rinsing pasta or vegetables. Riveted handles and rounded edges, on top and bottom, add to the strength.



ALUMINUM STRAINER

The grooved handle is riveted to the body for exceptional strength. The heavy-duty, dent-resistant body also has a securely riveted pan hook.

ITEM	DIAMETER		DEPTH		PACK
	IN	CM	IN	CM	
HA23	9	22.7	3 1/2	8.9	6
HA26	10 1/4	26	4	10.2	6

ITEM	CAPACITY		DIAMETER		DEPTH		PACK
	QT	L	IN	CM	IN	CM	
CA1611E	11	10.4	15	38.1	5 3/4	14.6	2
CA1616E	16	15.1	16	40.6	6 1/2	16.5	2



ALUMINUM COLANDER

Colanders are one-piece, deep drawn. For washing and draining fruits and vegetables.



R23

ITEM	DESCRIPTION	CAPACITY		DIAMETER		DEPTH		PACK
		QT	L	IN	CM	IN	CM	
1607A	Without Handles	12	11.3	12 3/4	32.4	5 3/8	13.7	6
1606A	Without Handles	15	14.2	16	40.6	6 3/4	17.1	6
1606H	With Handles	15	14.2	16	40.6	6 3/4	17.1	6

STAINLESS STEEL FOOTED COLANDER

Stainless steel colander with a mirror finish. Exceptionally durable and dent-resistant.

ITEM	CAPACITY		TOP DIAMETER		PACK
	QT	L	IN	CM	
R23	3	2.8	9 3/8	23.8	6
R27	5	4.8	10 1/2	26.7	6
R33	8	7.6	13 3/8	34	6
R39	13	12.3	16 3/8	41.6	6
R39D	13	12.3	14 3/4	37.5	6



R39D



S500 Series

MIXING BOWLS

The 500 series mixing bowls are a lighter weight but quality is not compromised. Tough stainless steel is mirror polished, with a rolled edge. Cleanup is especially quick and easy with the polished finish. Available in a variety of sizes. Capacities are approximate.

ITEM	CAPACITY		DIAMETER		PACK
	QT	L	IN	CM	
 S571	3/4	.7	6 1/2	16.5	12
S572	1 1/2	1.4	7 3/4	19.6	12
S573	3	2.8	9 1/2	24.1	12
S574	4	3.8	10 3/4	27.3	12
S575	5	4.7	11 1/2	29.2	12
S577	8	7.6	13 1/4	33.6	12
S579	13	12.3	16	40.6	12
S580	16	15.1	17 1/2	44.5	12
S581	20	18.9	18 3/4	47.6	12

STAINLESS STEEL MIXING BOWLS

The 700 series is the conventional mixing bowl line, combining top quality construction features. Weight is between light and heavy-duty, with mirror polish, stainless steel, and a rolled edge. Cleanup is exceptionally quick and easy. Available in a wide variety of sizes. Capacities are approximate.



S700 Series

ITEM	CAPACITY		DIAMETER		PACK
	QT	L	IN	CM	
S771	3/4	.7	6 1/2	16.5	12
S772	1 1/2	1.4	7 3/4	19.6	12
S773	3	2.8	9 1/2	24.1	12
S774	4	3.8	10 3/4	27.3	12
S775	5	4.7	11 1/2	29.2	12
S776	6 1/4	5.9	12 1/2	31.8	12
S777	8	7.6	13 1/4	33.6	12
S778	10 1/2	9.9	15	38.1	12
S779	13	12.3	16	40.6	12
S780	16	15.1	17 1/2	44.5	12
S781	20	18.9	18 3/4	47.6	12

HEAVY-DUTY MIXING BOWLS

The heavy-duty 800 series mixing bowls are built to withstand rough commercial use and made of tough stainless steel, a mirror polish, and a rolled edge. Cleanup is exceptionally quick and easy. Available in a wide variety of sizes. Capacities are approximate.



S800 Series

ITEM	CAPACITY		DIAMETER		PACK
	QT	L	IN	CM	
S871	3/4	.7	6 1/2	16.5	12
S872	1 1/2	1.4	7 3/4	19.6	12
S873	3	2.8	9 1/2	24.1	12
S874	4	3.8	10 3/4	27.3	12
S875	5	4.7	11 1/2	29.2	12
S876	6 1/4	5.9	12 1/2	31.8	12
S877	8	7.6	13 1/4	33.6	12
S878	10 1/2	9.9	15	38.1	12
S879	13	12.3	16	40.6	12
S880	16	15.1	17 1/2	44.5	12
S881	20	18.9	18 3/4	47.6	12

 Economy line offerings are identified by our green e-line icon and matching color-coded chart items.



MIXING BOWLS

Straight-sided stainless steel. Mirror finish and rolled edges make cleanup easy.

ITEM	CAPACITY		TOP DIAMETER		DEPTH		PACK
	QT	L	IN	CM	IN	CM	
MB1	1	.9	6 1/2	16.5	2 3/4	7	12
MB2	2	1.9	7 3/8	18.7	3 1/8	7.9	12
MB3	3	2.8	8 1/2	21.6	3 1/2	8.9	12

INSULATED MIXING BOWLS

Satin-finished stainless steel mixing bowls have a double wall for insulation. Insulated bowls can be used in cold table/chest or in other food presentation and display environments.



ITEM	CAPACITY		DIAMETER		PACK
	QT	L	IN	CM	
IMB1	1	.9	6 1/4	15.9	1
IMB2	2	1.9	7 13/16	19.8	1
IMB3	3	2.8	9 3/8	23.8	1

NYLON UTENSILS

Protect your non-stick or delicate surfaces with nylon utensils.



ITEM	DESCRIPTION	LENGTH		PACK
		IN	CM	
70843	Spoon	12 1/4	31	12
70846	Turner	13	33	12

"Conventional" Line Serving Spoons

Service from steam table pans is easy with medium or heavy gauge stainless steel spoons. Grooved handles add to the durability. Available with solid, perforated or slotted bowls.

Heavy gauge, highly polished spoons with a full-length reinforcement rib.

ITEM	DESCRIPTION	O/A LENGTH		PACK
		IN	CM	
2750	Solid	11	27.9	12
2760	Solid	13	33	12
2770	Solid	15	38.1	12
2752	Perforated	11	27.9	12
2762	Perforated	13	33	12
2772	Perforated	15	38.1	12
2754	Slotted	11	27.9	12
2764	Slotted	13	33	12
2774	Slotted	15	38.1	12



Medium gauge, highly polished spoons.

ITEM	DESCRIPTION	O/A LENGTH		PACK
		IN	CM	
3750	Solid	11	27.9	12
3760	Solid	13	33	12
3770	Solid	15	38.1	12
3752	Perforated	11	27.9	12
3762	Perforated	13	33	12
3772	Perforated	15	38.1	12
3754	Slotted	11	27.9	12
3764	Slotted	13	33	12
3774	Slotted	15	38.1	12



"RENAISSANCE" LINE SERVING SPOONS

Satin finish serving spoons feature a comfortable grooved handle and heavy-duty stainless steel that will not bend or break with normal use. Super heavy gauge, 18/8 stainless steel with 1.5 mm thickness.

ITEM	DESCRIPTION	O/A LENGTH		PACK
		IN	CM	
4750	Solid	11	27.9	12
4760	Solid	13	33	12
4770	Solid	15	38.1	12
4752	Perforated	11	27.9	12
4762	Perforated	13	33	12
4772	Perforated	15	38.1	12
4754	Slotted	11	27.9	12
4764	Slotted	13	33	12
4774	Slotted	15	38.1	12



EXTRA LONG HANDLED UTENSILS

You need an extra reach with large stock pots and steam table pans. The long handle is reinforced with a deep groove to ensure easy serving. Extra-long stainless steel utensils for heavy-duty serving.

ITEM	DESCRIPTION	O/A LENGTH		PACK
		IN	CM	
4780	Solid Spoon	18	45.7	12
4783P	Perforated Spoon	18	45.7	12
4781	Solid Spoon	21	53.3	12
4782	Fork	21 1/2	54.6	12
4784P	Perforated Spoon	21	53.3	12

Plastic Handle Spoons & Portioners

Commercial grade serving spoons and portioners have comfortable black or colored plastic handles, with a hanging hole. A grooved handle adds to the strength and durability. Available solid, perforated or slotted.



FOOD PORTIONER

Black handle utility portioner can be used for a variety of serving needs.

ITEM	DESCRIPTION	CAPACITY		LENGTH		PACK
		OZ	ML	IN	CM	
5722	Solid	2	59.1	10 1/4	26	12
5722P	Perforated	2	59.1	11 3/4	29.8	12
5723	Solid	3	88.7	9	22.9	12
5723P	Perforated	3	88.7	10 1/4	26	12
5724	Solid	4	118.3	10 1/2	26.7	12
5724P	Perforated	4	118.3	10 1/4	26	12
5728	Solid	8	236.6	10 1/4	26	12
5728P	Perforated	8	236.6	9	22.9	12

SERVING SPOONS

Heavy gauge steel spoon with a black plastic handle.

ITEM	DESCRIPTION	O/A LENGTH		PACK
		IN	CM	
5750	Solid	11	27.9	12
5760	Solid	13	33	12
5761	Solid - 3 sided	13	33	12
5770	Solid	15	38.1	12
5752	Perforated	11	27.9	12
5762	Perforated	13	33	12
5763	Perforated - 3 sided	13	33	12
5772	Perforated	15	38.1	12
5754	Slotted	11	27.9	12
5764	Slotted	13	33	12
5774	Slotted	15	38.1	12

ONE-PIECE FOOD PORTIONERS

The long-handled portion controlled spoons are color-coded for quick identification. Five sizes available in both perforated and solid. Bowl and handle made of one-piece construction so bowl will not break off and there is no weld joint where food can collect.

ITEM	DESCRIPTION	HANDLE COLOR	CAPACITY		LENGTH		PACK
			OZ	ML	IN	CM	
5742	Solid	Red	2	59	10 1/2	26.7	12
5742P	Perforated	Red	2	59	10 1/2	26.7	12
5742PG	Perforated	Green	2	59	10 1/2	26.7	12
5743	Solid	Beige	3	88	10 1/2	26.7	12
5743P	Perforated	Beige	3	88	10 1/2	26.7	12
5744	Solid	Green	4	118	10 1/2	26.7	12
5744P	Perforated	Green	4	118	10 1/2	26.7	12
5746	Solid	Black	6	176	10 1/2	26.7	12
5746P	Perforated	Black	6	176	10 1/2	26.7	12
5748	Solid	Blue	8	236	10 1/2	26.7	12
5748P	Perforated	Blue	8	236	10 1/2	26.7	12





FOOD PORTIONER

One piece food portioners with purple color handle, designated for the preparation of allergen-free foods.

ITEM	DESCRIPTION	HANDLE COLOR	CAPACITY		LENGTH		PACK
			OZ	ML	IN	CM	
6722	Solid	Purple	2	59	13	33	12
6722P	Perforated	Purple	2	59	13	33	12
6723	Solid	Purple	3	88	13	33	12
6723P	Perforated	Purple	3	88	13 ¼	33.7	12
6724	Solid	Purple	4	118	13 ¾	34.9	12
6724P	Perforated	Purple	4	118	13 ¾	34.9	12
6726	Solid	Purple	6	176	14 ¼	36.2	12
6726P	Perforated	Purple	6	176	14 ¼	36.2	12
6728	Solid	Purple	8	238	14 ¾	37.5	12
6728P	Perforated	Purple	8	238	14 ¾	37.5	12



5710

MEASURING CUP/FOOD PORTIONER

Solid deep cup provides portion control. Available in 1/4, 1/3, 1/2, and 1 cup capacities.

ITEM	CAPACITY		LENGTH		PACK
	OZ	ML	IN	CM	
5721	2	59.1	12 1/4	31.1	12
5713	3	88.7	13	33	12
5712	4	118.3	13 3/8	34	12
5710	8	236.5	13 3/4	34.9	12

"Conventional" Line Ladles

A wide range of capacities and handle lengths ensure the right tool for the job. The heavy gauge ladles have a satin finish, making cleanup easy. The hooked handle rests on the rim of the pot or can be used for hanging.

ITEM	CAPACITY		HANDLE		PACK
	OZ	ML	IN	CM	
273912	1/2	14.8	10 1/2	26.7	12
2741	1	29.6	10 1/2	26.7	12
274112	1 1/2	44.4	9	22.9	12
2742	2	59.1	10 1/4	26	12
2743	3	88.7	10	25.4	12
2744	4	118.3	12	30.5	12
2746	6	177.4	11 3/4	29.8	12
2748	8	236.5	12 1/4	31.1	12
2712	12	354.8	12 1/4	31.1	12
2716	16	473.1	14 3/4	37.5	12
2724	24	709.7	14 3/4	37.5	12
2732	32	946.2	14 3/4	37.5	12



2741



0405

"DEMI" LINE LADLES

A smaller capacity and length makes these perfect for serving delicate fruits, sauces, condiments or gravies from smaller containers. Mirror polished, 18/8 stainless steel construction features a grooved and hooked handle.

ITEM	CAPACITY		HANDLE		PACK
	OZ	ML	IN	CM	
0404	1/2	14.8	4 3/4	12	12
0405	1	29.6	5	12.7	12

"RENAISSANCE" LINE LADLES

Super heavy-duty is the only way to describe these ladles. The satin finish 18/8 stainless steel is 2.5 mm thick. With capacities ranging from 1/2 to 12 ounces, they'll provide years of dependable service, whether you're feeding a small town or an army.



3739

ITEM	CAPACITY		HANDLE		PACK
	OZ	ML	IN	CM	
3739	1/2	14.8	9	22.9	12
3740	3/4	22.2	9	22.9	12
3741	1	29.6	9 1/4	23.5	12
374112	1 1/2	44.4	8 3/4	22.2	12
3742	2	59.1	10 1/4	26	12
3743	3	88.7	10 1/4	26	12
3744	4	118.3	12 1/2	31.8	12
3746	6	177.4	12 1/2	31.8	12
3748	8	236.5	12 1/2	31.8	12
3712	12	354.8	12	30.5	12

FLAT BOTTOM PIZZA LADLES

The flat bottom design is made to spread sauce evenly on pizza crust.

ITEM	CAPACITY		HANDLE		PACK
	OZ	ML	IN	CM	
86113	5	147.9	15	38.1	12
61116	6	177.4	15	38.1	12



61116



Economy line offerings are identified by our green e-line icon and matching color-coded chart items.

SOUP LADLES

Ideal handle design for hanging inside vegetable insets or bain marie pots.

ITEM	CAPACITY		HANDLE		PACK
	OZ	ML	IN	CM	
9944L	4	118.3	13	33	12
9946L	6	177.9	14	35.6	12
9948L	8	236.5	14	35.6	12

Polycarbonate Serving Ladles

A variety of polycarbonate ladles designed for salad bar and back of the house use. See full line of plastic utensils in our Plasticware chapter, page 73.

LADLES

1 oz., 29.6 ml capacity

ITEM	COLOR	HANDLE		PACK
		IN	CM	
 PC8841-10	White	7 1/2	19.1	12
PC8841-20	Red	7 1/2	19.1	12
PC8841-30	Green	7 1/2	19.1	12
PC8841-40	Clear-Blue Tint	7 1/2	19.1	12
PC8841-50	Black	7 1/2	19.1	12
PC8841-60	Beige	7 1/2	19.1	12



SAUCE LADLES

1/2 oz., 15 ml capacity

ITEM	COLOR	LENGTH		PACK
		IN	CM	
 PC1011-10	White	11	27.9	12
PC1011-20	Red	11	27.9	12
PC1011-30	Green	11	27.9	12
PC1011-40	Clear-Blue Tint	11	27.9	12
PC1011-50	Black	11	27.9	12
PC1011-60	Beige	11	27.9	12



1 PC. LADLE W/ BLACK PVC HANDLES

An alternate version to the "Optima" line of ladles with a black utility grip handle.

ITEM	CAPACITY		HANDLE		PACK
	OZ	ML	IN	CM	
9939BLK	1/2	14.8	10 3/4	27.3	12
994112BLK	1 1/2	44.4	11	27.9	12
9942BLK	2	59.1	11	27.9	12
9943BLK	3	88.7	11 1/2	29.5	12
9944BLK	4	118.3	12	30.5	12
9946BLK	6	177.9	12 3/8	31.4	12
9948BLK	8	236.5	12 1/2	31.8	12
9912BLK	12	354.8	13	33	12



72932

DIPPER

Stainless steel dipper for liquids or beverages.

ITEM	DESCRIPTION	CAPACITY		HANDLE		PACK
		OZ	ML	IN	CM	
72919	w/ Solder Seal	32	946.2	12 1/2	31.8	24
72932	w/o Solder Seal	32	946.2	12 1/2	31.8	24



7742

"ULTRA" LINE LADLES

This is probably the most durable ladle on the market today. With its super heavy-weight, 18/8 stainless steel make-up, and a capacity range up to 12 ounces, this ladle is ideal for thick soups.

ITEM	CAPACITY		HANDLE		PACK
	OZ	ML	IN	CM	
7739	1/2	14.8	9	22.8	12
7741	1	29.6	9 1/4	23.5	12
7742	2	59.1	9 1/4	23.5	12
7743	3	88.7	10	25.4	12
7744	4	118.3	13	33	12
7746	6	177.4	13	33	12
7748	8	236.5	13 1/2	34.3	12
7712	12	354.8	15	38.1	12



“OPTIMA” LINE LADLES

These ladles have a beautiful mirror finish. The stainless steel, one-piece construction has a reinforced, grooved handle to remain rigid for excellent serving control. They also come with color-coded plastic handles (see below) for easy capacity identification.

ITEM	CAPACITY		HANDLE		
	OZ	ML	IN	CM	PACK
8839	1/2	14.8	10 3/4	27.3	12
8841	1	29.6	11	27.9	12
8842	2	59.1	11	27.9	12
8843	3	88.7	11 1/2	29.2	12
8844	4	118.3	12	30.5	12
8846	6	177.9	12 3/8	31.4	12
8848	8	236.5	12 1/2	31.8	12
8812	12	354.8	13	33	12
8816	16	473.1	13	33	12



“OPTIMA” LINE-SHORT HANDLE W/STRAIGHT SIDED BOWL

	CAPACITY		LENGTH		PACK
	OZ	ML	IN	CM	
8839SHSS	1/2	14.8	5 3/4	14.6	12
8841SHSS	1	29.6	5 3/4	14.6	12
884112SHSS	1 1/2	44.3	5 3/4	14.6	12
8842SHSS	2	59.1	5 3/4	14.6	12
8845SHSS	5	147.5	5 3/4	14.6	12
8846SHSS	6	177.9	5 3/4	14.6	12
8848SHSS	8	236.5	5 3/4	14.6	12



“OPTIMA” SHORT-HANDLED LADLES

ITEM	CAPACITY		HANDLE		PACK
	OZ	ML	IN	CM	
8839SH	1/2	14.8	5 1/2	14	12
8841SH	1	29.6	5 1/2	14	12
884112SH	1 1/2	44.4	5 1/2	14	12
8842SH	2	59.1	5 1/2	14	12
8843SH	3	88.7	5 1/2	14	12
8844SH	4	118.3	5 1/2	14	12



“OPTIMA” LINE COLOR-CODED LADLES

ITEM	DESCRIPTION	CAPACITY		HANDLE		PACK
		OZ	ML	IN	CM	
8839GR	Green	1/2	14.8	10 3/4	27.3	12
8841BLK	Black	1	29.6	11	27.9	12
884112WH	White	1 1/2	44.4	11	27.9	12
8842BL	Blue	2	59.1	11	27.9	12
8843IV	Ivory	3	88.7	11 1/2	29.5	12
8844GY	Gray	4	118.3	12	30.5	12
8846TL	Teal	6	177.9	12 3/8	31.4	12
8848OR	Orange	8	236.5	12 1/2	31.8	12
8812RD	Red	12	354.8	13	33	12

Can Openers

Alegacy is pleased to present an extensive and expanded line of can openers for every chefs' needs. From table punch type for large size cans to hand-held openers, we offer a wide variety to suit your use and your budget. Our newest line Easy Turn™ is available in our premium quality, heavy-duty U.S.A.-made openers, as well as an imported economy offering, for budget-minded customers.

Table Models

Ideal for extra-large cans, these can openers are made with a sturdy, cast iron body and handle. The knife and gears are heat-treated and reversible. A full line of replacement parts is also available.

ALEGACY CAN OPENER

These table models with plated steel base plate open up to gallon size cans. Both models are available with a long bar and all parts are available for replacement.



ITEM	DESCRIPTION	SHAFT LENGTH		PACK
		IN	CM	
AL010	Heavy-Duty Hotel Model	13 1/4	33.7	3
AL010LB	Heavy-Duty Hotel Model - Long Bar	20	50.8	3
AL010NB	Heavy-Duty Hotel Model - Without Base	14	35.6	3
AL020	Standard Restaurant Model	13	33	6
AL020LB	Standard Restaurant Model - Long Bar	15	38.1	6
AL020NB	Standard Restaurant Model - Without Base	11 1/2	29.2	6

CAN OPENER-PARTS LIST

Specify model numbers. Parts are not interchangeable between sizes.

ITEM	DESCRIPTION	PACK	ITEM	DESCRIPTION	PACK
AL010G	Gear	1	AL01002BPS	Base Plate Screws	1
AL010K	Knife	1	AL020G	Gear	1
AL010RP	Retainer	1	AL020K	Knife	1
AL010SB	Body Only	1	AL020SB	Body Only	1
AL010KH	Knife Holder	1	AL020KH	Knife Holder	1
AL010H	Handle	1	AL020H	Handle	1
AL010A	Arbor/Shaft	1	AL020A	Arbor/Shaft	1
AL010B	Spacer/Bushing	1	AL020B	Spacer/Bushing	1
AL010KHP	Knife Holder Pin	1	AL020KHP	Knife Holder Pin	1
AL010WS	Wheel Spacer	1	AL020S	Spring	1
AL010S	Spring	1	AL020W	Washer	1
AL010W	Washer	1	AL020BP	Base Plate	1
AL010BP	Base Plate	1	AL020SP	Spring Pin	1
AL010SP	Spring Pin	1	SCREW12	Screw	1

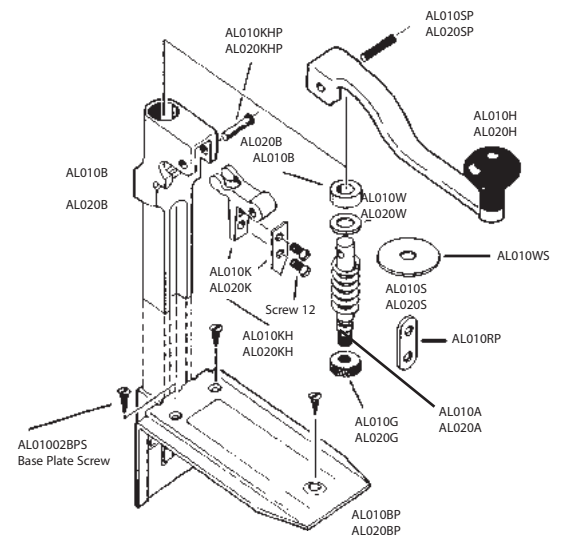



by Alegacy Foodservice Products Group, Inc.

Manual Openers

Available in both U.S.A.-made heavy-duty construction and our economy import line, we proudly offer the easiest-turning, highest quality openers of all steel construction with hardened, sharpened cutting wheel.



92418RD



92419BLK

MANUAL CAN OPENERS

High quality, made in U.S.A.

ITEM	GRIP COLOR	LENGTH		
		IN	CM	PACK
92417WH	White	7	17.8	6
92418RD	Red	7	17.8	6
92419BLK	Black	7	17.8	6



92415RD

MANUAL CAN OPENERS

Imported economy versions.

ITEM	GRIP COLOR	LENGTH		
		IN	CM	PACK
 92409WH	White	6 1/2	16.5	6
92410RD	Red	6 1/2	16.5	6
92411BLK	Black	6 1/2	16.5	6
92412WH	White	7	17.8	6
92413RD	Red	7	17.8	6
92414BLK	Black	7	17.8	6
92415RD	Red	7 3/4	19.7	6
92416BLK	Black	9 1/2	24.1	6



92416BLK



92412WH

 Economy line offerings are identified by our green e-line icon and matching color-coded chart items.

Ice Cream Dishers

Our two lines of ice cream dishers look very similar but are built differently to accommodate your needs. The economy line is sturdy and cost-effective, while the premium line is long lasting, paying off in the long run.

 Economy line offerings are identified by our green e-line icon and matching color-coded chart items.

ICE CREAM/FOOD DISHERS

Sizes are indicated by handle color and stamped on the bowl knife blade for easy portion control. Disher is stainless steel with all metal parts and meets U.S. government standards. Individually boxed.



ITEM	SIZE	CAPACITY		HANDLE COLOR	PACK
		OZ	ML		
AL1266	6	4 2/3	138	White	1
AL1268	8	4	118.3	Gray	1
AL12610	10	3 3/4	110.9	Cream	1
AL12612	12	3 1/4	96.1	Green	1
AL12616	16	2 3/4	81.3	Blue	1
AL12620	20	2 1/2	73.9	Yellow	1
AL12624	24	1 3/4	51.8	Red	1
AL12630	30	1 1/4	37	Black	1
AL12640	40	7/8	25.9	Purple	1



ECONOMY ICE CREAM/FOOD DISHERS

The budget minded operator will enjoy these functional economy ice cream dishers. Sizes are indicated by handle color. Disher is stainless steel and is individually boxed.

ITEM	SIZE	CAPACITY		HANDLE COLOR	PACK
		OZ	ML		
 AL1286	6	4 2/3	138	White	1
AL1288	8	4	118.3	Gray	1
AL12810	10	3 3/4	110.9	Cream	1
AL12812	12	3 1/4	96.1	Green	1
AL12816	16	2 3/4	81.3	Blue	1
AL12820	20	2 1/2	73.9	Yellow	1
AL12824	24	1 3/4	51.8	Red	1
AL12830	30	1 1/4	37	Black	1
AL12840	40	7/8	25.9	Purple	1



ICE CREAM SCOOP/DISHER

New ergonomic color coded handles make these dishers an easy scoop. Dishers are stainless steel with all metal parts and meets U.S. government standards. Packed in an attractive individual box.

ITEM	SIZE	CAPACITY		HANDLE COLOR	PACK
		OZ	ML		
AL1306	6	4 2/3	138	White	1
AL1308	8	4	118.3	Gray	1
AL13010	10	3 3/4	110.9	Cream	1
AL13012	12	3 1/4	96.1	Green	1
AL13016	16	2 3/4	81.3	Blue	1
AL13020	20	2 1/2	73.9	Yellow	1
AL13024	24	1 3/4	51.8	Red	1
AL13030	30	1 1/4	37	Black	1
AL13040	40	7/8	25.9	Purple	1



STAINLESS STEEL ICE CREAM DISHERS

Dishers/portioners are all stainless steel with a twin grip. Sizes are stamped on the bowl knife blade. Individually boxed.

ITEM	SIZE	CAPACITY		PACK
		OZ	ML	
E1256	6	4 2/3	138	1
E1258	8	4	118.3	1
E12510	10	3 3/4	110.9	1
E12512	12	3 1/4	96.1	1
E12516	16	2 3/4	81.3	1
E12520	20	2 1/2	73.9	1
E12524	24	1 3/4	51.8	1
E12530	30	1 1/4	37	1
E12540	40	7/8	25.9	1
E12550	50	5/8	18.5	1
E12560	60	9/16	16.6	1
E12570	70	31/64	14.3	1
E125100	100	3/8	11.1	1



ICE CREAM SPADE

Spade is a one-piece stainless steel blade with a black plastic handle.

ITEM	O/A LENGTH		PACK
	IN	CM	
114X	9	22.9	12



SPECIALTY ICE CREAM/FOOD DISHERS

Three sizes and shapes of plastic handled dishers provide the tools to make a truly fabulous and rare presentation. Individually boxed.

ITEM	SHAPE	SIZE	CAPACITY		
			OZ	ML	PACK
HDU12225	Heart	25	1 3/8	40	1
SDU12220	Square	20	1 5/8	50	1
SDU12230	Square	30	1 2/15	33.3	1



ICE CREAM/FOOD DISHERS

These high quality, solid brass and chrome-plated dishers have a round bowl, with the capacity measurement stamped on the blade. A twin grip handle operates the stainless steel spring for easy portion release.

ITEM	SIZE	CAPACITY		
		OZ	ML	PACK
U1218	8	4 1/10	121.2	1
U12110	10	2 5/8	77.6	1
U12112	12	2 1/4	66.5	1
U12116	16	1 2/3	49.3	1
U12120	20	1 1/2	44.4	1
U12124	24	1 1/10	32.5	1
U12130	30	15/16	27.7	1
U12140	40	13/16	24	1
U12150	50	11/16	20.3	1
U12160	60	9/16	16.6	1
U12170	70	3/8	11.1	1
U121100	100	1/4	7.4	1



OVAL ICE CREAM DISHER

Highest quality solid brass, chrome-plated with a stainless steel spring. Twin grip with the sizes stamped on bowl knife blade. Individually boxed.

ITEM	SIZE	CAPACITY		
		OZ	ML	PACK
ODU12130	30	15/16	27.7	1



U122 Series

PLASTIC HANDLE

ICE CREAM/FOOD DISHERS

Plastic handle dishers provide a lighter weight food disher. The portion capacity is identified by a size stamp on the round bowl knife blade. Individually boxed.

ITEM	SIZE	CAPACITY		
		OZ	ML	PACK
U1228	8	4 1/10	121.2	1
U12210	10	2 5/8	77.6	1
U12212	12	2 1/4	66.5	1
U12216	16	1 2/3	49.3	1
U12220	20	1 1/2	44.4	1
U12224	24	1 1/10	32.5	1
U12230	30	15/16	27.7	1
U12240	40	13/16	24	1
U12250	50	11/16	20.3	1
U12260	60	9/16	16.6	1
U12270	70	3/8	11.1	1
U122100	100	1/4	7.4	1



ICE CREAM DIPPER

High quality German made dipper has no moving parts that can bend or break. It releases portions instantly, defrosts automatically, and works well for left or right hand. Individually boxed.

ITEM	SIZE	PACK
ALST12	12	1
ALST16	16	1
ALST20	20	1
ALST24	24	1
ALST30	30	1
ALST40	40	1

ONE-PIECE ALUMINUM ICE CREAM DIPPER

High quality polished aluminum dipper has no moving parts that can break. It releases portions instantly, defrosts automatically, and works well for left or right hand. Individually boxed.

ITEM	SIZE	PACK
AL12SD	12	1
AL16SD	16	1
AL20SD	20	1
AL24SD	24	1
AL30SD	30	1



NON-STICK ONE-PIECE ALUMINUM ICE CREAM DIPPER

This high-tech dipper releases instantly and defrosts automatically. Food particles won't stick to the non-stick coating, and the one-piece construction has no moving parts to break. It is naturally balanced for left or right handed operation. The dipper cleans easily with a soft cloth or sponge. Individually boxed.

ITEM	SIZE	PACK
82012	12	1
82016	16	1
82020	20	1
82024	24	1
82030	30	1

PLASTIC SCOOP

One-piece durable plastic construction. It is dishwasher safe, non-toxic, and available in red or white. Ideal for dry cereal, flour, and sugar.



ITEM	DESCRIPTION	BOWL SIZE		PACK
		IN	CM	
840PSW	White	6 1/4 x 3 1/4 x 2 3/8	15.9 x 8.3 x 6	48
840PSR	Red	6 1/4 x 3 1/4 x 2 3/8	15.9 x 8.3 x 6	48

STAINLESS STEEL SCOOPS

These stainless steel scoops offer versatility of use for both dry and wet products. The scoops have a mirror polished finish outside and inside.

ITEM	CAPACITY		BOWL SIZE		PACK
	OZ	ML	IN	CM	
SS10008	1.5	44.4	3 5/16 x 1 5/8	8.4 x 4.1	12
SS100010	2	59.2	3 3/4 x 2	9.5 x 5.1	12
SS100012	3.5	103.6	4 3/4 x 2 5/16	12 x 5.9	12
SS100014	6	177.6	5 1/2 x 2 3/4	14 x 7	12
SS100015	8	236.8	6 x 3 1/2	15.2 x 8.9	12



PLASTIC SCOOP - FLAT BOTTOM

One-piece durable plastic. Dishwasher safe and non-toxic. Often used for ice bins.

ITEM	CAPACITY		BOWL SIZE		PACK
	OZ	ML	IN	CM	
15173	82	2424.7	9 1/2 x 5 3/4 x 3 1/2	24.1 x 14.6 x 8.9	36



STAINLESS STEEL BAR SCOOP

Tapered shape is perfect for scooping ice into glasses. The handle is welded to the bowl. Sturdy 18/8 stainless steel.

ITEM	O/A LENGTH		
	IN	CM	PACK
246	9 1/2	24.1	12



ALUMINUM SCOOPS

Scoop is made of die-cast aluminum, highly polished inside and outside. The handle has a grooved finish with finger grip to prevent slipping.

ITEM	CAPACITY		BOWL SIZE		PACK
	OZ	ML	IN	CM	
100012	5	147.9	4 3/4 x 2 3/8	12.1 x 6	12
100016	12	354.8	5 7/8 x 3 1/8	14.9 x 13	12
100020	24	709.7	7 1/4 x 4	18.4 x 10.2	12
100023	38.8	1147.3	8 3/4 x 4 3/4	22.2 x 12.1	12
100026	57.5	1700.3	10 1/2 x 5 1/2	26.7 x 14	12
100030	84.5	2498.7	12 x 6 1/4	30.5 x 15.9	12

See page 36 for additional economy scoops.



PC100064

PC10006

POLYCARBONATE SCOOPS

Clear blue tinted scoops excellent for use with ice and/or dry foods.

ITEM	CAPACITY		HEIGHT		PACK
	OZ	ML	IN	CM	
 PC10006	6	177.4	4 5/8 x 2 x 1 3/4	11.7 x 5.1 x 4.4	12
PC100012	12	354.8	5 3/4 x 2 1/2 x 2	14.6 x 6.4 x 5.1	12
PC100024	24	709.8	6 3/4 x 3 3/4 x 2 1/4	17.1 x 9.5 x 5.7	12
PC100064	64	1892.7	9 1/2 x 5 1/2 x 3 1/2	24.1 x 14 x 8.9	12



ALUMINUM SCOOPS - FLAT BOTTOM

Scoop is made of one-piece cast aluminum with a tumbled finish. Now comes in three convenient sizes.

ITEM	CAPACITY		BOWL SIZE		PACK
	OZ	ML	IN	CM	
B147	7	207	5 1/2 x 3 1/4	14 x 8.3	12
B175	16	473.1	7 x 4 1/4	17.8 x 10.8	12
B172	44	1301.5	8 1/2 x 5 1/2	21.6 x 14	12

FRENCH WIRE WHIPS

18/8 stainless steel, wires are fully enclosed in handle and are NSF listed. Thicker wires for whipping eggs, egg whites, and heavier food products.

ITEM	O/A LENGTH		
	IN	CM	PACK
FW10NSF	10	25.4	12
FW12NSF	12	30.5	12
FW14NSF	14	35.6	12
FW16NSF	16	40.6	12
FW18NSF	18	45.7	12
FW20NSF	20	50.8	12
FW22NSF	22	55.8	12
FW24NSF	24	60.9	12



ICE SCOOPS

Scoop is die-cast aluminum, one-piece with a polished finish.

ITEM	O/A LENGTH		
	IN	CM	PACK
123	9	22.8	12
248	8	20.3	12



PW16NSF

PIANO WIRE WHIPS

18/8 stainless steel, wires are fully enclosed in handle and are NSF listed. For whipping delicate sauces.

ITEM	O/A LENGTH		
	IN	CM	PACK
PW8NSF	8	20.3	12
PW10NSF	10	25.4	12
PW12NSF	12	30.5	12
PW14NSF	14	35.6	12
PW16NSF	16	40.6	12
PW18NSF	18	45.7	12



FW18NSF

 Economy line offerings are identified by our green e-line icon and matching color-coded chart items.

STAINLESS STEEL FRENCH WIRE WHIP

18/8 stainless steel, available in silver soldered or epoxy.
Thicker wires for whipping eggs, egg whites, and heavier food products.

SOLDERED

ITEM	O/A LENGTH		PACK
	IN	CM	
FW10	10	25.4	12
FW12	12	30.5	12
FW14	14	35.6	12
FW16	16	40.6	12
FW18	18	45.7	12
FW20	20	50.8	12
FW22	22	55.8	12
FW24	24	60.9	12

EPOXY

ITEM	O/A LENGTH		PACK
	IN	CM	
FW310	10	25.4	12
FW312	12	30.5	12
FW314	14	35.6	12
FW316	16	40.6	12
FW318	18	45.7	12
FW320	20	50.8	12
FW322	22	55.8	12
FW324	24	60.9	12



Soldered Finish



Epoxy Finish

STAINLESS STEEL PIANO WIRE WHIP

18/8 stainless steel, available in silver soldered or epoxy.
For whipping delicate sauces and toppings.

SOLDERED

ITEM	O/A LENGTH		PACK
	IN	CM	
PW10	10	25.4	12
PW12	12	30.5	12
PW14	14	35.6	12
PW16	16	40.6	12
PW18	18	45.7	12

EPOXY

ITEM	O/A LENGTH		PACK
	IN	CM	
PW310	10	25.4	12
PW312	12	30.5	12
PW314	14	35.6	12
PW316	16	40.6	12
PW318	18	45.7	12



LONG HANDLE WHIP

Sturdy, long handle is perfect for deep mixer bowls.
Stainless steel with ball or tear drop design.

ITEM	STYLE	O/A LENGTH		PACK
		IN	CM	
MW40	Tear Drop	40	101.6	1
KW49	Ball	49	124.5	1



ROUND FACE MASHER

Easy-to-clean stainless steel face with a chrome-plated or stainless steel handle.

ITEM	DESCRIPTION	LENGTH		BASE DIAMETER		PACK
		IN	CM	IN	CM	
1726	All Stainless Steel	25	63.5	5	12.7	1



WOODEN SPOON

Standard weight wooden spoon is for light-duty use.

ITEM	O/A LENGTH		PACK
	IN	CM	
8310	10	25.4	12
8312	12	30.5	12
8314	14	35.6	12
8316	16	40.6	12
8318	18	45.7	12

EXTRA HEAVY WOODEN SPOON

Extra heavy weight spoons for commercial and institutional use.

ITEM	O/A LENGTH		PACK
	IN	CM	
8310EH	10	25.4	12
8312EH	12	30.5	12
8314EH	14	35.6	12
8316EH	16	40.6	12
8318EH	18	45.7	12



HEAVY-DUTY WOODEN SPOON

High-density hardwood spoon with superior finish, for professional applications.

ITEM	O/A LENGTH		
	IN	CM	PACK
8310HD	10	25.4	12
8312HD	12	30.5	12
8314HD	14	35.6	12
8316HD	16	40.6	12

LONG HANDLE HEAVY WOODEN SPOON

Professional quality, size, and weight.

ITEM	O/A LENGTH		
	IN	CM	PACK
8424EH	24	60.9	12
8428EH	28	71.1	12



MASHER-SQUARE FACE WOOD HANDLE

Nickel-plated with a base of one continuous piece and a hardwood handle.

ITEM	LENGTH		BASE		PACK
	IN	CM	IN	CM	
1618	18	45.7	4 x 5	10.2 x 12.7	12
1623	23	58.4	5 x 5 3/4	12.7 x 14.6	12



MASHER-ROUND FACE WOOD HANDLE

Nickel-plated with base rods securely welded and a hardwood handle. Long handles easily reach into deep pots.

ITEM	LENGTH		BASE DIAMETER		PACK
	IN	CM	IN	CM	
1718	18	45.7	4 1/2	11.4	12
1725	25	63.5	5	12.7	12



STAINLESS STEEL SPRING TONGS

Pioneered with AISI 430 2B stainless steel, these heavy-duty tongs provide high quality corrosion resistance in the toughest kitchen environments. They are spring operated with a scalloped edge, available in three weights.

STANDARD

ITEM	DESCRIPTION	THICKNESS		LENGTH		PACK
		IN	MM	IN	CM	
3511	Standard	.02	.5	9 1/2	24.1	12
3511EH	Heavy	.03	.8	9 1/2	24.1	12
2511	Extra Heavy	.04	1	9 1/2	24.1	12
3512	Standard	.02	.5	12	30.5	12
3512EH	Heavy	.03	.8	12	30.5	12
2512	Extra Heavy	.04	1	12	30.5	12
3513	Standard	.02	.5	16	40.6	12
3513EH	Heavy	.03	.8	16	40.6	12
2513	Extra Heavy	.04	1	16	40.6	12
3511S	Spring Only					

ECONOMY

Common grade stainless steel with a scalloped edge. Available in three weights.

LOCKING TONG

Stainless steel quality tong with locking mechanism to keep tongs orderly for storage.

ITEM	LENGTH		PACK
	IN	CM	
9511	9 1/2	24.1	12
9512	12	30.5	12
9513	16	40.6	12



LOCKING TONGS

Spring operated, extra-heavy 1.2 mm thickness. Scalloped edges. Locking mechanism to keep tongs orderly for storage.

ITEM	LENGTH		PACK
	IN	CM	
1009	9 1/2	24.1	12
1012	12	30.5	12
1013	16	40.6	12



ITEM	DESCRIPTION	THICKNESS		LENGTH		PACK
		IN	MM	IN	CM	
6511	Standard	.02	.5	9 1/2	24.1	12
7511	Heavy	.03	.8	9 1/2	24.1	12
8511	Extra Heavy	.04	1	9 1/2	24.1	12
6512	Standard	.02	.5	12	30.5	12
7512	Heavy	.03	.8	12	30.5	12
8512	Extra Heavy	.04	1	12	30.5	12
6513	Standard	.02	.5	16	40.6	12
7513	Heavy	.03	.8	16	40.6	12
8513	Extra Heavy	.04	1	16	40.6	12



SPRING TONG

Scalloped gripping edges, spring operated.

ITEM	LENGTH		
	IN	CM	PACK
3507	7	17.8	12

STAINLESS STEEL TONG

One-piece construction is easy to handle and clean.



ITEM	LENGTH		
	IN	CM	PACK
11511	6 1/2	16.5	12
11521	9	22.9	12
11531	12	30.5	12



SPAGHETTI TONG

Designed to easily serve cooked noodles. Spring steel with blunted tip on each side.

ITEM	LENGTH		
	IN	CM	PACK
5313	7 1/2	19.1	12

SPRING TONG

Spring operated, extra-heavy 1.2 mm thickness. Scalloped edges.



ITEM	LENGTH		
	IN	CM	PACK
4511	9 1/2	24.1	12
4512	12	30.5	12
4513	16	40.6	12

 Economy line offerings are identified by our green e-line icon and matching color-coded chart items.



COLORCODE SYSTEM STAINLESS TONGS

Scalloped edge tongs with color-coding takes the risk and guess work out of cross-contamination. Also available in black for general utility.



ITEM	DESCRIPTION	LENGTH		PACK
		IN	CM	
5511BK	Black	9 1/2	24.1	12
5511BL	Blue	9 1/2	24.1	12
5511GR	Green	9 1/2	24.1	12
5511RD	Red	9 1/2	24.1	12
5511TN	Tan	9 1/2	24.1	12
5511WH	White	9 1/2	24.1	12
5511YL	Yellow	9 1/2	24.1	12
5512BK	Black	12	30.5	12
5512BL	Blue	12	30.5	12
5512GR	Green	12	30.5	12
5512RD	Red	12	30.5	12
5512TN	Tan	12	30.5	12
5512WH	White	12	30.5	12
5512YL	Yellow	12	30.5	12
5513BK	Black	16	40.6	12
5513BL	Blue	16	40.6	12
5513GR	Green	16	40.6	12
5513RD	Red	16	40.6	12
5513TN	Tan	16	40.6	12
5513WH	White	16	40.6	12
5513YL	Yellow	16	40.6	12



STAINLESS STEEL TONG

Now available in purple to identify use for anti-allergen requirements.

ITEM	LENGTH			PACK
	IN	CM		
5511PL	9 1/2	24.1		12
5512PL	12	30.5		12
5513PL	16	40.6		12



STAINLESS STEEL TONG WITH CLAW

Ideal for use with ice, cakes or pastries.

ITEM	DESCRIPTION	LENGTH			PACK
		IN	CM		
1157	Scalloped	7 1/4	18.4		12
1158	w/ "Chicken Feet"	6 1/2	16.5		12



HEAVY-DUTY TONGS

Chrome-plated, professional quality scissor type. For serving meats and other heavier items.

ITEM	LENGTH			PACK
	IN	CM		
N186	14 1/2	36.8		12



HINGED FORK-SPOON SALAD SET

Fork and spoon are hinged at the center. They can also be used separately. Great for use in salad bars and buffet lines.

ITEM	LENGTH			PACK
	IN	CM		
0113	11 1/2	29.2		12

For additional serving tongs & utensils in plastic, see Plasticware chapter, Page 73.



DOUGH SCRAPER

Stainless steel blade with nickel-plated rivets. Excellent for dividing dough and scraping dough from flat surfaces.

ITEM	DESCRIPTION	LENGTH		PACK
		IN	CM	
182DS	Hardwood	4 x 6	10.2 x 15.2	12
182PH	Plastic	4 x 6	10.2 x 15.2	12
183	Hardwood	5 x 7	12.7 x 17.8	12

BOWL SCRAPER

Flexible plastic forms easily to bowl surfaces and the firm flat edge allows for many creative uses.

ITEM	LENGTH		PACK
	IN	CM	
FS8446	5 3/4 x 3 1/2	14.6 x 8.9	144



PLATE SCRAPER

Multipurpose scraper for mixing, scraping, and spreading. Smooth, wooden handle.

ITEM	DESCRIPTION	LENGTH		PACK
		IN	CM	
1265	Medium Blade	10	25.4	24
1266	Large Blade	12 1/2	31.7	24



SPOON SHAPE SCRAPERS*

Plastic handle molded spoon shaped scraper.

ITEM	LENGTH		PACK
	IN	CM	
61771	10	25.4	2
61774	14	35.6	1
61777	16	40.7	1

ONE-PIECE SCRAPER*

Plastic handle molded flat plate or bowl scraper.

ITEM	LENGTH		PACK
	IN	CM	
71771	10	25.4	24
71774	14	35.5	12
71777	16	40.6	12



HIGH HEAT SCRAPERS - UP TO 600°*

The flat silicone blade and nylon handled scrapers are designed to withstand high heat applications, up to 600°F (315°C).

ITEM	LENGTH		PACK
	IN	CM	
81771	10	25.4	6
81774	14	35.6	6
81777	16	40.7	6



HIGH HEAT SPOON SHAPE SCRAPERS - UP TO 600°*

Crafted for versatility, these spoon shaped scrapers can withstand temperatures up to 600°F (315°C).

ITEM	LENGTH		PACK
	IN	CM	
91771	10	25.4	6
91774	14	35.6	6
91777	16	40.7	6

* All scrapers are blister carded as pictured.



SQUARE GRATER

Stainless steel grater for grating or slicing meats, cheeses, and potatoes.

ITEM	HEIGHT			PACK
	IN	CM		
SSG4	9 1/2	24.1		12



SQUARE GRATER

This grater has both two grating and two slicing surfaces.

ITEM	DESCRIPTION	HEIGHT			PACK
		IN	CM		
3199	Stainless Steel	9	22.9		12

ALUMINUM EGG WEDGER

Divider is polished, die-cast aluminum with heavy-duty spring. It cuts six equal sections of egg.



ITEM	HEIGHT			PACK
	IN	CM		
A133	4 3/4	12		1



SINGLE EGG SLICER

Cut egg slices quickly for salads and garnishes with this die-cast, polished aluminum slicer.

ITEM	DIAMETER			PACK
	IN	CM		
230	4 1/4	10.8		12



SQUARE GRATER

Four different grating surfaces for fine to coarse grating. Made of easy-to-clean stainless steel.

ITEM	HEIGHT			PACK
	IN	CM		
SSG449	9	22.9		24



ALUMINUM CHEESE SLICER

Slicer is die-cast polished aluminum with an adjustable roller. Avoids the high cost of buying pre-sliced cheese.

ITEM	DESCRIPTION	WIRE LENGTH		PACK
		IN	CM	
386	Individually Packed	4	10.1	12
386W	Wire Only	4	10.1	12

ALUMINUM BUTTER CUTTER

Quarter-pound sections can be cut into 18 pieces for tabletop serving. The die-cast frame is piano wire bound. Eliminates the need for pre-packaged butter patties.

ITEM	LENGTH			PACK
	IN	CM		
291	7 3/4	19.7		12



PEELER

Fruit and vegetable peeler with double edge floating blade. Serrated blade can be used for scraping and coring.

ITEM	DESCRIPTION	BLADE LENGTH		PACK
		IN	CM	
3K	Nickel-Plated	2 1/2	6.3	12
5KP	All Stainless Steel	2 1/2	6.3	12



APPLE DIVIDER

Die-cast metal with rustproof knives. Cuts 14 equal slices and cores apples at the same time.

ITEM	DIAMETER				PACK
	IN	CM	SLICES		
A134	3 1/2	8.9	14		1



GARLIC PRESS

Press individual garlic cloves through holes for cooking sized garlic pieces with this economical, die-cast aluminum press.

ITEM	LENGTH		PACK
	IN	CM	
777	6	15.2	12



HEAVY-DUTY GARLIC PRESS

Die-cast aluminum of heavy-duty construction. The plate of poly teeth push through holes for thorough self-cleaning.

ITEM	LENGTH		PACK
	IN	CM	
1777WP	8	20.3	12



FRUIT OR VEGETABLE SCOOP

Perfect for making melon balls. Polished steel bowl with a wooden or plastic handle.

ITEM	HANDLE	BOWL DIAMETER		LENGTH		PACK
		IN	CM	IN	CM	
1226	Wood	1 / 1/4	2.5 / 3.1	7	17.8	12
1226PH	Plastic	1 / 1/4	2.5 / 3.1	7	17.8	12



TOMATO CORER

Extract tomato cores with our handy, stainless steel corer.

ITEM	DESCRIPTION	BOWL DIAMETER		LENGTH		PACK
		IN	CM	IN	CM	
TC1	Stainless Steel	3/4	1.9	4 1/4	10.8	24



GARNISH/SERRATOR

Stainless steel corrugated blade with a hardwood handle. Use to make french fries, carrot slices, and garnishes.

ITEM	BLADE DIMENSIONS		PACK
	IN	CM	
923P	7 1/4 x 2	18.4 x 5.1	12

STEAK TENDERIZER

Hardwood handle with a cast aluminum head, one face is coarse cut and the other is fine cut for different degrees of tenderizing. 202ST is all aluminum.



ITEM	MALLET		LENGTH		PACK
	IN	CM	IN	CM	
201ST	3 x 3	7.6 x 7.6	13	33	12
202ST	2 1/2 x 3	6.4 x 7.6	10 1/2	26.7	12



ALL-PURPOSE BASTER

Rubber with a nylon tube.

ITEM	LENGTH		
	IN	CM	PACK
2220	11	27.9	12



STAINLESS STEEL WIRE SKEWER

Reusable, easy-to-clean skewer for cooking and serving. Polished stainless steel with a loop handle and a pointed end.

ITEM	LENGTH			WIRE	PACK
	IN	CM			
N127	8	20.3		Round	144
N130	10	25.4		Round	144



OVAL WIRE SKEWER

Polished stainless steel with a loop handle and a pointed end. Oval wire design makes it easier to insert skewer into food.

ITEM	LENGTH		
	IN	CM	PACK
850	8	20.3	144
1050	10	25.4	144
1250	12	30.5	144



ROUND WIRE SKEWER

Polished stainless steel, for faster cooking of foods, with a loop handle and a pointed tip.

ITEM	LENGTH		
	IN	CM	PACK
8RS	8	20.3	144
10RS	10	25.4	144
12RS	12	30.5	144



PLASTIC CORN HOLDERS

Simulated yellow corn handles with nickel prongs safely and securely hold corn cobs.

ITEM	LENGTH		
	IN	CM	PACK
1522	2 1/2	6.3	144



STAINLESS STEEL CUTLERY BOX

Stainless steel, polished finish, wire beaded edge with four seamless compartments and an open bottom. Trim size box fits under counters for convenient storage. Easy to sanitize.

ITEM	IN	CM	PACK
289	10 x 16 1/2 x 3 5/8	25.4 x 41.9 x 9.2	8



6 COMPARTMENT MESS TRAY

The stainless steel, polished finish trays won't bend or warp like plastic trays.

ITEM	IN	CM	THICKNESS	PACK
1216SS	12 x 16	30.5 x 40.6	.6 mm	24



FOOD MILL

Heavy stainless steel bowl with perforated, conical shaped bottom. Has an adjustable straining blade. Strains or purees fruits, vegetables, and more.

ITEM	CAPACITY		PACK
	QT	L	
501SS	2	1.9	6
50112SS	3 1/2	3.3	3



ROTARY EGG BEATER

Stainless steel beater and shaft with nylon gears and a plastic handle.

ITEM	LENGTH		
	IN	CM	PACK
947EB	10	25.4	12

STAINLESS STEEL POTATO RICER

Stainless steel with bowl securely welded to frame. Heavy-duty large portion model.



ITEM	O/A LENGTH		CUP SIZE		PACK
	IN	CM	IN	CM	
3RS	17	43.1	5 1/2 x 4 3/4	14 x 12.1	1



TOSTADA BASKET

Make freshly fried tostadas every day with this heavy-duty polished chrome finish tostada basket.

ITEM	IN	CM	PACK
TSB8L	9 1/2 x 6 1/2 x 3	24.1 x 16.5 x 7.6	1



TACO BASKET

Make taco shells safely, quickly, and easily. Handle has a low heat-transferring design. Heavy-duty construction features a fry kettle hook and a polished chrome finish. For use in 28-35 lb or larger fry kettles. Molds up to 8 shells per load.

ITEM	IN	CM	PACK
TB8M	12 x 6 3/4 x 4	30.5 x 17.1 x 10.2	1



HAM HOLDER

Makes cooking and carving ham faster and easier. Holder keeps ham out of fats and juices while cooking. 3/16" (.5 cm) chrome-plated wire.

TOP DIMENSION			
ITEM	IN	CM	PACK
13200	6 1/2 x 6	16.5 x 15.2	1



CULINARY BASKET

For stove top frying of single servings or small orders, as well as breading. Baskets are made of nickel-plated steel wire. Fine mesh is 1/8" (.3 cm), medium mesh is 1/4" (.6 cm), coarse mesh is 1/2" (1.3 cm).

ITEM	DESCRIPTION	DIAMETER		PACK
		IN	CM	
79751	Fine Mesh	8	20.3	6
79754	Fine Mesh	10	25.4	6
79757	Fine Mesh	12	30.5	6
79741	Medium Mesh	8	20.3	6
79744	Medium Mesh	10	25.4	6
79747	Medium Mesh	12	30.5	6
79731	Coarse Mesh	8	20.3	6
79734	Coarse Mesh	10	25.4	6
79737	Coarse Mesh	12	30.5	6



STEAK WEIGHT

Weights are cast aluminum or iron, with a ribbed flat bottom and a wooden handle that will not heat up. Keeps edges of steaks from curling during cooking.



ITEM	DESCRIPTION	IN	CM	HANDLE TO FIT	PACK
705	Aluminum	8 1/4 x 4 1/4	20.9 x 10.8	707H	12
709	Gray Iron	8 1/4 x 4 1/4	20.9 x 10.8	707H	12
706	Gray Iron	9 x 5 1/4	22.8 x 13.3	707H	12
707	Aluminum	9 x 5 1/4	22.8 x 13.3	707H	12
708	Aluminum	10 7/8 x 9 1/8	27.6 x 23.1	707H	12
707H	Wood	5 3/4	14.6		1



LONG-RING MINUTE TIMER

Times in minutes up to one hour and has an insistent ring up to 18 seconds. Blister carded.

ITEM	FACE DIAMETER			PACK
	IN	CM		
1929	2 3/4	6.9		12



MINUTE TIMER

Times in minutes up to one hour and has a single ring. Blister carded.

ITEM	FACE DIAMETER			PACK
	IN	CM		
2428	2 1/2	6.3		12

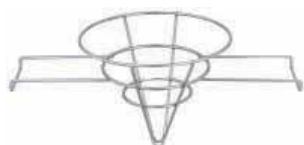

GREASE FILTER CONE RACK

Conical type wire rack holds grease filter cones over draining receptacle.

ITEM	IN	CM	PACK
678	18 3/4 x 9	47.6 x 22.9	12

GREASE FILTER CONES

Heavy weight filter paper that will filter oil, lard, and other fats used in fryers. Each case has ten boxes with fifty per box.



ITEM	DIAMETER		HEIGHT		PACK
	IN	CM	IN	CM	
678C	10	25.4	9	22.9	10/50's



ALEGACY SCOURING PAD

Tough nylon webbing makes these pads non-rusting and non-shredding. They rinse clean, are odorless, are economical for all scouring jobs, and are also easy on the hands. They can be used dry but are more effective when wet or with scouring agents.

ITEM	IN	CM	PACK
3400	6 x 9 1/2	15.2 x 24.1	10 Pads per Box 6 Boxes per Case



LID-OFF

Open plastic pails quickly and easily with this safe, time saving tool. It won't distort lids and allows them to be reclosed.

ITEM	DESCRIPTION	LENGTH		
		IN	CM	PACK
89052	Plastic	7 3/4	19.7	12
89054	Anodized aluminum	7 3/4	19.7	12



RUBBER SCRAP BLOCK

Made of molded rubber and fits standard worktable openings for efficient disposal of food scraps and peelings.

ITEM	DIAMETER		INSET DIAMETER		COLOR	PACK
	IN	CM	IN	CM		
829W	6 1/2	16.5	4 1/2	11.4	White	1



STAINLESS STEEL SPONGES

Industrial strength coiled sponges can handle the toughest kitchen cleanup.

ITEM	DIAMETER		
	IN	CM	PACK
AL300	3	7.6	6



CHEF COAT

Double-breasted 63/35 poly-cotton twill blends, they are extra comfortable and durable.

ITEM	DESCRIPTION	SIZE	PACK
CCW1S	Small	32-34	12
CCW2M	Medium	36-38	12
CCW3L	Large	40-42	12
CCW3XL	Extra Large	48-50	12



CHEF'S HAT

Professional, classically styled chef's hat is made of 100% cotton, with a velcro closure and three inch headband.

ITEM	HEIGHT		PACK
	IN	CM	
CH13V	10	25.4	48
CH16V	13	33	48

BIB APRON

Full bib style, made of 50/50 poly-cotton blend with nylon waist ties and two pockets (except BIA1).

ITEM	IN	CM	COLOR	PACK
BIA1	32 x 34	81.2 x 86.3	White	12
BIA2B	32 x 27	81.2 x 68.5	Blue	12
BIA3GR	32 x 27	81.2 x 68.5	Green	12
BIA6BR	32 x 27	81.2 x 68.5	Brown	12
BIA7R	32 x 27	81.2 x 68.5	Red	12

VINYL APRON

A great apron for bartenders and wait staff because it is water resistant. 32 oz leatherette vinyl.

ITEM	DESCRIPTION	IN	CM	PACK
AP2730	Full Apron	27 x 30	68.5 x 76.2	12



DISHWASHER'S APRON

Super lightweight, oversized vinyl apron, with plastic grommets and nylon ties.

ITEM	IN	CM	PACK
DA3944	37 x 25	94 x 63.5	12



GRILL/OVEN MITT

All-cotton fabric is coated with aluminized silicones. Its non-stick coating wipes clean with a damp cloth. Sold in pairs.

ITEM	LENGTH		PACK
	IN	CM	
SOM13	13	33	72 pr
SOM15	15	38.1	72 pr
SOM17	17	43.1	72 pr



GRILL/OVEN MITT

The fabric is all-cotton, treated to retard fire. Protects up to 400°F and is water and stain repellent. Sold in pairs.

ITEM	LENGTH		PACK
	IN	CM	
POM13	13	33	72 pr
POM15	15	38.1	72 pr
POM17	17	43.1	72 pr
POM24	24	60.9	72 pr



GRILL/OVEN MITT

100% cotton for a thicker padding, mitt is flame retardant. Sold in pairs.

ITEM	LENGTH		PACK
	IN	CM	
FRM13	13	33	72 pr
FRM15	15	38.1	72 pr
FRM17	17	43.1	72 pr



HANDLE HOLDER

All-purpose grip protector.

ITEM	LENGTH		PACK
	IN	CM	
AH6	6 1/2	16.4	12



HAND PROTECTOR

Thick close-knit terry with inside layer for protection against hot liquids.

ITEM	IN	CM	PACK
HP11	8 1/2 x 11	21.6 x 27.9	12



HANDLE HOLDER

Ideal for handling and serving with cast iron pans. Made from Teflon® coated cotton.

ITEM	LENGTH		PACK
	IN	CM	
HP1T	6 1/2	16.5	12



POT HOLDER

Silicone with a metallic silver finish. Wipes clean easily.

ITEM	IN	CM	PACK
PHS8	8 x 8	20.3 x 20.3	12

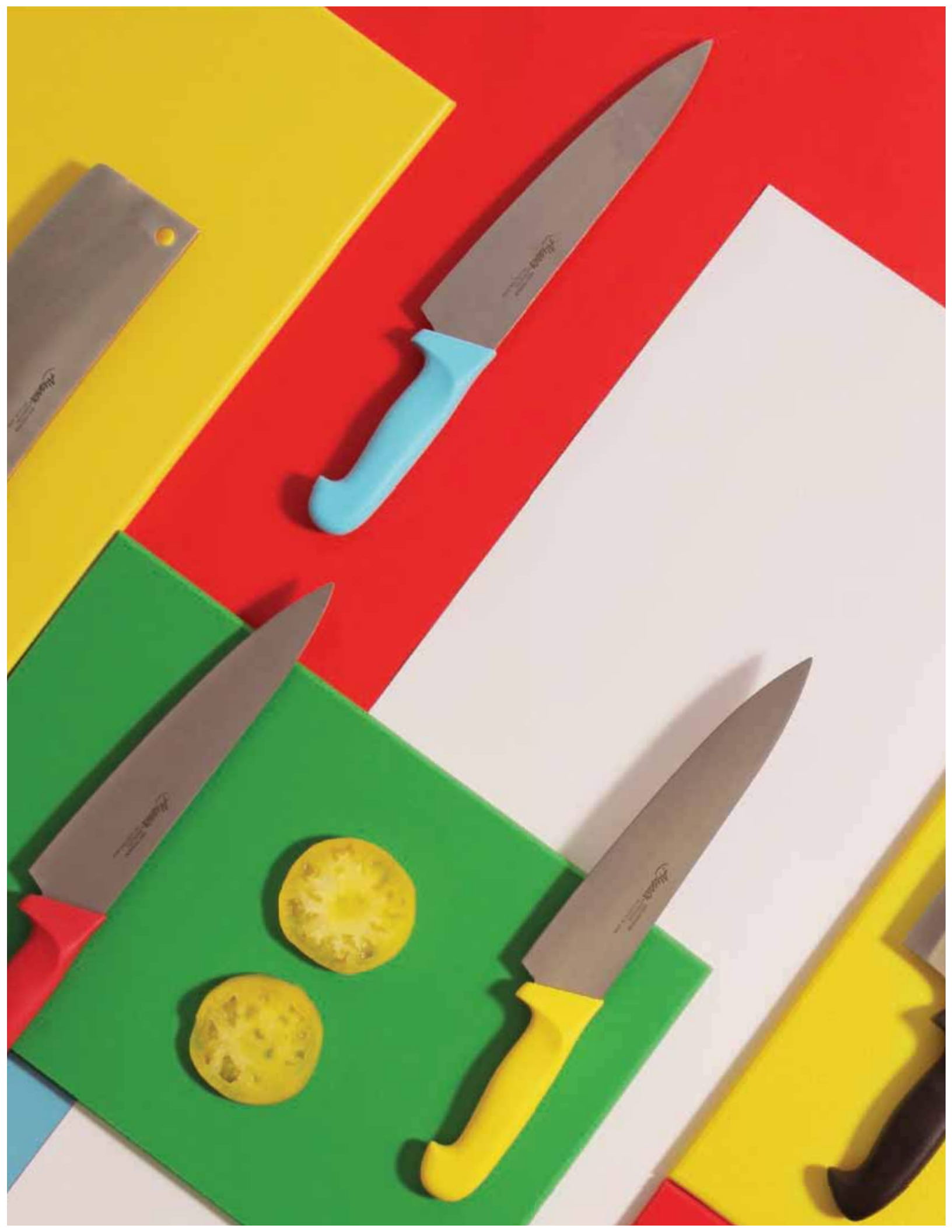

FOOD PREPARATION

Cutting Boards

148 - 151

Cutlery

152 - 156

Turners & Spatulas

157 - 160

Steak Knives

161

Cutlery Accessories

162 - 164

Poultry Shears

165

Cast Iron Ware

166 - 167

Hand Tools

168 - 171

Scales

172 - 173

Thermometers

174 - 176

Allergen-Free ColorCode

177



ColorCode System Cutting Boards

The tough task of safe food preparation is simple with the ColorCode System that takes the risk out of cross-contamination. The boards are color-coded by food group. They're non-absorbent and won't harbor food-borne bacteria. The non-skid surface won't dull knives, chip, crack, peel or warp. They're dishwasher safe and contamination can be further reduced with our matching knives. Custom cut boards are also available.

POLYETHYLENE CUTTING BOARD

ColorCode cutting boards are the ultimate defense in the prevention of cross-contamination. Exceptionally durable and essential for safe food preparation. The high-density polyethylene is dishwasher safe. Made in the U.S.A. See next page for white boards.



ITEM	COLOR	IN	CM	PACK
PER1218B	Blue	12 x 18 x 1/2	30.5 x 45.7 x 1.3	6
PER1218G	Green	12 x 18 x 1/2	30.5 x 45.7 x 1.3	6
PER1218R	Red	12 x 18 x 1/2	30.5 x 45.7 x 1.3	6
PER1218T	Tan	12 x 18 x 1/2	30.5 x 45.7 x 1.3	6
PER1218Y	Yellow	12 x 18 x 1/2	30.5 x 45.7 x 1.3	6
PER1218AST	Assorted	12 x 18 x 1/2	30.5 x 45.7 x 1.3	1/6
PER1520B	Blue	15 x 20 x 1/2	38.1 x 50.8 x 1.3	6
PER1520G	Green	15 x 20 x 1/2	38.1 x 50.8 x 1.3	6
PER1520R	Red	15 x 20 x 1/2	38.1 x 50.8 x 1.3	6
PER1520T	Tan	15 x 20 x 1/2	38.1 x 50.8 x 1.3	6
PER1520Y	Yellow	15 x 20 x 1/2	38.1 x 50.8 x 1.3	6
PER1520AST	Assorted	15 x 20 x 1/2	38.1 x 50.8 x 1.3	1/6
PER1824B	Blue	18 x 24 x 1/2	45.7 x 61 x 1.3	3
PER1824G	Green	18 x 24 x 1/2	45.7 x 61 x 1.3	3
PER1824R	Red	18 x 24 x 1/2	45.7 x 61 x 1.3	3
PER1824T	Tan	18 x 24 x 1/2	45.7 x 61 x 1.3	3
PER1824Y	Yellow	18 x 24 x 1/2	45.7 x 61 x 1.3	3
PER1824AST	Assorted	18 x 24 x 1/2	45.7 x 61 x 1.3	2/3

ITEM	COLOR	IN	CM	PACK
PEL1218B	Blue	12 x 18 x 1	30.5 x 45.7 x 2.5	6
PEL1218G	Green	12 x 18 x 1	30.5 x 45.7 x 2.5	6
PEL1218R	Red	12 x 18 x 1	30.5 x 45.7 x 2.5	6
PEL1218T	Tan	12 x 18 x 1	30.5 x 45.7 x 2.5	6
PEL1218Y	Yellow	12 x 18 x 1	30.5 x 45.7 x 2.5	6
PEL1520B	Blue	15 x 20 x 1	38.1 x 50.8 x 2.5	3
PEL1520G	Green	15 x 20 x 1	38.1 x 50.8 x 2.5	3
PEL1520R	Red	15 x 20 x 1	38.1 x 50.8 x 2.5	3
PEL1520T	Tan	15 x 20 x 1	38.1 x 50.8 x 2.5	3
PEL1520Y	Yellow	15 x 20 x 1	38.1 x 50.8 x 2.5	3
PEL1824B	Blue	18 x 24 x 1	45.7 x 61 x 2.5	3
PEL1824G	Green	18 x 24 x 1	45.7 x 61 x 2.5	3
PEL1824R	Red	18 x 24 x 1	45.7 x 61 x 2.5	3
PEL1824T	Tan	18 x 24 x 1	45.7 x 61 x 2.5	3
PEL1824Y	Yellow	18 x 24 x 1	45.7 x 61 x 2.5	3

ITEM	COLOR	IN	CM	PACK
PEM1218B	Blue	12 x 18 x 3/4	30.5 x 45.7 x 1.9	6
PEM1218G	Green	12 x 18 x 3/4	30.5 x 45.7 x 1.9	6
PEM1218R	Red	12 x 18 x 3/4	30.5 x 45.7 x 1.9	6
PEM1218T	Tan	12 x 18 x 3/4	30.5 x 45.7 x 1.9	6
PEM1218Y	Yellow	12 x 18 x 3/4	30.5 x 45.7 x 1.9	6
PEM1520B	Blue	15 x 20 x 3/4	38.1 x 50.8 x 1.9	6
PEM1520G	Green	15 x 20 x 3/4	38.1 x 50.8 x 1.9	6
PEM1520R	Red	15 x 20 x 3/4	38.1 x 50.8 x 1.9	6
PEM1520T	Tan	15 x 20 x 3/4	38.1 x 50.8 x 1.9	6
PEM1520Y	Yellow	15 x 20 x 3/4	38.1 x 50.8 x 1.9	6
PEM1824B	Blue	18 x 24 x 3/4	45.7 x 61 x 1.9	3
PEM1824G	Green	18 x 24 x 3/4	45.7 x 61 x 1.9	3
PEM1824R	Red	18 x 24 x 3/4	45.7 x 61 x 1.9	3
PEM1824T	Tan	18 x 24 x 3/4	45.7 x 61 x 1.9	3
PEM1824Y	Yellow	18 x 24 x 3/4	45.7 x 61 x 1.9	3



WHITE POLYETHYLENE CUTTING BOARD

These high-density polyethylene boards have an easy to clean, non-skid surface with shaped edges. They will not dull knives or warp. Available in a variety of thicknesses and individually shrink-wrapped. Made in the U.S.A.

ITEM	IN	CM	PACK
PER69	6 x 9 x 1/2	15.2 x 22.9 x 1.3	12
PER1218	12 x 18 x 1/2	30.5 x 45.7 x 1.3	6
PER1520	15 x 20 x 1/2	38.1 x 50.8 x 1.3	6
PER1824	18 x 24 x 1/2	45.7 x 61 x 1.3	3
PER1830	18 x 30 x 1/2	45.7 x 76.2 x 1.3	3
PEM69	6 x 9 x 3/4	15.2 x 22.9 x 1.9	12
PEM1218	12 x 18 x 3/4	30.5 x 45.7 x 1.9	6
PEM1520	15 x 20 x 3/4	38.1 x 50.8 x 1.9	6
PEM1824	18 x 24 x 3/4	45.7 x 61 x 1.9	3
PEM1830	18 x 30 x 3/4	45.7 x 62 x 1.9	3
PEL69	6 x 9 x 1	15.2 x 22.9 x 2.5	12
PEL1218	12 x 18 x 1	30.5 x 45.7 x 2.5	6
PEL1520	15 x 20 x 1	38.1 x 50.8 x 2.5	3
PEL1824	18 x 24 x 1	45.7 x 61 x 2.5	3
PEL1830	18 x 30 x 1	45.7 x 76.2 x 2.5	3

SLABS

PER4896	48 x 96 x 1/2	121.9 x 243.8 x 1.3	1
PEM4896	48 x 96 x 3/4	121.9 x 243.8 x 1.9	1
PEL4896	48 x 96 x 1	121.9 x 243.8 x 2.5	1



CUTTING BOARD CLEANING BRUSHES

Choose between six color-coded brushes to help keep your ColorCode cutting boards clean and functional.

ITEM	COLOR	IN	CM	PACK
CBB1R	Red	6 1/2 x 2 1/2	16.5 x 6.4	12
CBB2Y	Yellow	6 1/2 x 2 1/2	16.5 x 6.4	12
CBB3BL	Blue	6 1/2 x 2 1/2	16.5 x 6.4	12
CBB4TN	Tan	6 1/2 x 2 1/2	16.5 x 6.4	12
CBB5GR	Green	6 1/2 x 2 1/2	16.5 x 6.4	12
CBB6WH	White	6 1/2 x 2 1/2	16.5 x 6.4	12

Please inquire about custom size boards for prep tables, sandwich tables, and other food service applications.

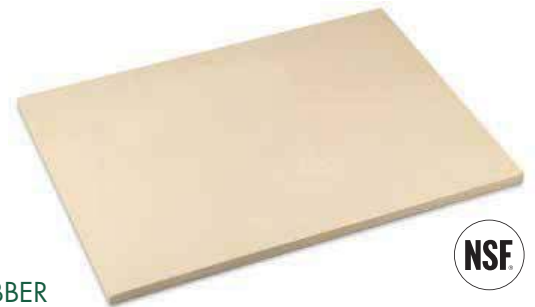

HARD RUBBER CUTTING BOARD

Choose from a wide selection of surface sizes to fit just right. These boards have a non-skid surface that will not dull cutlery, scar or warp. Made in the U.S.A. and individually shrink-wrapped.

ITEM	IN	CM	PACK
R1218	12 x 18 x 1/2	30.5 x 45.7 x 1.3	6
R1520	15 x 20 x 1/2	38.1 x 50.8 x 1.3	6
R1824	18 x 24 x 1/2	45.7 x 61 x 1.3	3
M1218	12 x 18 x 3/4	30.5 x 45.7 x 1.9	6
M1520	15 x 20 x 3/4	38.1 x 50.8 x 1.9	6
M1824	18 x 24 x 3/4	45.7 x 61 x 1.9	3
L1218	12 x 18 x 1	30.5 x 45.7 x 2.5	6
L1520	15 x 20 x 1	38.1 x 50.8 x 2.5	3
L1824	18 x 24 x 1	45.7 x 61 x 2.5	3

SLABS

R3696	36 x 96 x 1/2	91.4 x 243.8 x 1.3	1
M3696	36 x 96 x 3/4	91.4 x 243.8 x 1.9	1
L3696	36 x 96 x 1	91.4 x 243.8 x 2.5	1



CUTTING BOARD STORAGE RACKS

Conveniently stores cutting boards for drying and space saving. You may also use the storage rack with the ColorCode System cutting boards to complete the cross-contamination control.

ITEM	IN	CM	PACK
26099	12 x 11 1/2 x 10 3/4	30.4 x 29.2 x 27.3	1



MEDIUM DENSITY POLYETHYLENE CUTTING BOARD

White boards, medium density, with both sides usable.

ITEM	IN	CM	PACK
 PER1218MD	12 x 18 x 1/2	30.5 x 45.7 x 1.3	6
PER1520MD	15 x 20 x 1/2	38.1 x 50.8 x 1.3	6
PER1824MD	18 x 24 x 1/2	45.7 x 61 x 1.3	3
PEM1218MD	12 x 18 x 3/4	30.5 x 45.7 x 1.9	6
PEM1520MD	15 x 20 x 3/4	38.1 x 50.8 x 1.9	6
PEM1824MD	18 x 24 x 3/4	45.7 x 61 x 1.9	3
PEL1218MD	12 x 18 x 1	30.5 x 45.7 x 2.5	6
PEL1520MD	15 x 20 x 1	38.1 x 50.8 x 2.5	3
PEL1824MD	18 x 24 x 1	45.7 x 61 x 2.5	3

MEDIUM DENSITY POLYETHYLENE COLORCODE SYSTEM BOARDS

Lighter weight, economy boards are all color-coded to provide the best control over cross-contamination.

Non-porous, non-absorbent and easy to clean for the safest food preparation.

ITEM	COLOR	IN	CM	PACK
 PER1218MBL	Blue	12 x 18 x 1/2	30.5 x 45.7 x 1.3	6
PER1218MTN	Tan	12 x 18 x 1/2	30.5 x 45.7 x 1.3	6
PER1218MG	Green	12 x 18 x 1/2	30.5 x 45.7 x 1.3	6
PER1218MR	Red	12 x 18 x 1/2	30.5 x 45.7 x 1.3	6
PER1218MY	Yellow	12 x 18 x 1/2	30.5 x 45.7 x 1.3	6
PER1520MBL	Blue	15 x 20 x 1/2	38.1 x 50.8 x 1.3	6
PER1520MTN	Tan	15 x 20 x 1/2	38.1 x 50.8 x 1.3	6
PER1520MG	Green	15 x 20 x 1/2	38.1 x 50.8 x 1.3	6
PER1520MR	Red	15 x 20 x 1/2	38.1 x 50.8 x 1.3	6
PER1520MY	Yellow	15 x 20 x 1/2	38.1 x 50.8 x 1.3	6
PER1824MBL	Blue	18 x 24 x 1/2	45.7 x 61 x 1.3	3
PER1824MTN	Tan	18 x 24 x 1/2	45.7 x 61 x 1.3	3
PER1824MG	Green	18 x 24 x 1/2	45.7 x 61 x 1.3	3
PER1824MR	Red	18 x 24 x 1/2	45.7 x 61 x 1.3	3
PER1824MY	Yellow	18 x 24 x 1/2	45.7 x 61 x 1.3	3



 All items on this page are part of our economy line offerings, identified by our green e-line icon and matching color-coded chart items.

ITEM	COLOR	IN	CM	PACK
 PEM1218MBL	Blue	12 x 18 x 3/4	30.5 x 45.7 x 1.9	6
PEM1218MTN	Tan	12 x 18 x 3/4	30.5 x 45.7 x 1.9	6
PEM1218MG	Green	12 x 18 x 3/4	30.5 x 45.7 x 1.9	6
PEM1218MR	Red	12 x 18 x 3/4	30.5 x 45.7 x 1.9	6
PEM1218MY	Yellow	12 x 18 x 3/4	30.5 x 45.7 x 1.9	6
PEM1520MBL	Blue	15 x 20 x 3/4	38.1 x 50.8 x 1.9	6
PEM1520MTN	Tan	15 x 20 x 3/4	38.1 x 50.8 x 1.9	6
PEM1520MG	Green	15 x 20 x 3/4	38.1 x 50.8 x 1.9	6
PEM1520MR	Red	15 x 20 x 3/4	38.1 x 50.8 x 1.9	6
PEM1520MY	Yellow	15 x 20 x 3/4	38.1 x 50.8 x 1.9	6
PEM1824MBL	Blue	18 x 24 x 3/4	45.7 x 61 x 1.9	3
PEM1824MTN	Tan	18 x 24 x 3/4	45.7 x 61 x 1.9	3
PEM1824MG	Green	18 x 24 x 3/4	45.7 x 61 x 1.9	3
PEM1824MR	Red	18 x 24 x 3/4	45.7 x 61 x 1.9	3
PEM1824MY	Yellow	18 x 24 x 3/4	45.7 x 61 x 1.9	3

ITEM	COLOR	IN	CM	PACK
 PEL1218MBL	Blue	12 x 18 x 1	30.5 x 45.7 x 2.5	6
PEL1218MTN	Tan	12 x 18 x 1	30.5 x 45.7 x 2.5	6
PEL1218MG	Green	12 x 18 x 1	30.5 x 45.7 x 2.5	6
PEL1218MR	Red	12 x 18 x 1	30.5 x 45.7 x 2.5	6
PEL1218MY	Yellow	12 x 18 x 1	30.5 x 45.7 x 2.5	6
PEL1520MBL	Blue	15 x 20 x 1	38.1 x 50.8 x 2.5	3
PEL1520MTN	Tan	15 x 20 x 1	38.1 x 50.8 x 2.5	3
PEL1520MG	Green	15 x 20 x 1	38.1 x 50.8 x 2.5	3
PEL1520MR	Red	15 x 20 x 1	38.1 x 50.8 x 2.5	3
PEL1520MY	Yellow	15 x 20 x 1	38.1 x 50.8 x 2.5	3
PEL1824MBL	Blue	18 x 24 x 1	45.7 x 61 x 2.5	3
PEL1824MTN	Tan	18 x 24 x 1	45.7 x 61 x 2.5	3
PEL1824MG	Green	18 x 24 x 1	45.7 x 61 x 2.5	3
PEL1824MR	Red	18 x 24 x 1	45.7 x 61 x 2.5	3
PEL1824MY	Yellow	18 x 24 x 1	45.7 x 61 x 2.5	3

ALLERGEN-FREE COLORCODE SYSTEM BOARDS

Purple color, in a medium density, is designated for the preparation of allergen-free foods.



ITEM	COLOR	IN	CM	PACK
 PER1218MP	Purple	12 x 18 x 1/2	30.1 x 45.7 x 1.3	6
PER1520MP	Purple	15 x 20 x 1/2	38.1 x 50.8 x 1.3	6
PER1824MP	Purple	18 x 24 x 1/2	45.7 x 61 x 1.3	3



FRUIT BOARD

One-piece hardwood construction is smooth on both sides.

ITEM	IN	CM	PACK
691	6 x 9 x 1	15.2 x 22.9 x 2.5	12

SECTIONAL CUTTING BOARD

Both sides are finished, making them reversible. Kiln-dried maple boards are waterproof glued. Do not immerse in water for cleaning.



ITEM	IN	CM	PACK
11218	12 x 18 x 1 3/4	30.5 x 45.7 x 4.4	1
11520	15 x 20 x 1 3/4	38.1 x 50.8 x 4.4	1
11824	18 x 24 x 1 3/4	45.7 x 61 x 4.4	1
11830	18 x 30 x 1 3/4	45.7 x 76.2 x 4.4	1



HAM BOARD

Sanded hardwood with chamfered edges. 814S is slotted.

ITEM	IN	CM	PACK
814	13 1/2 x 7	34.3 x 17.8	12
814S	13 1/2 x 7	34.3 x 17.8	12



ROUND LEMON BOARD

Hardwood board with a groove to catch juice.

ITEM	IN	CM	PACK
350LB	7	17.8	12



SMALL CHEESE BOARD

Made of hardwood with both sides smooth and slotted to hold slicer.

ITEM	IN	CM	PACK
5814S	11 1/2 x 5 1/2	29.2 x 13.9	12

ColorCode System Knives

Each knife is designated to a specific food group providing the absolute best protection against cross-contamination. Use them with their matching ColorCode cutting boards, tongs and spatulas for a safe food prep environment.



COOK'S KNIFE

ColorCode handles correspond to their specific food group to avoid cross-contamination: use blue for cooked foods, green for fruits and vegetables, red for meat, tan for fish and seafood, white for dairy products, and yellow for poultry. Blades are made from rigid molybdenum stainless steel.

ITEM	BLADE LENGTH		ITEM	BLADE LENGTH		COLOR	PACK
	IN	CM		IN	CM		
PC12910BL	10	25.4	PC12912BL	12	30.5	Blue	6
PC12910GR	10	25.4	PC12912GR	12	30.5	Green	6
PC12910RD	10	25.4	PC12912RD	12	30.5	Red	6
PC12910TN	10	25.4	PC12912TN	12	30.5	Tan	6
PC12910WH	10	25.4	PC12912WH	12	30.5	White	6
PC12910YL	10	25.4	PC12912YL	12	30.5	Yellow	6



BONING KNIFE

ColorCode knives are also available with a 6" blade for boning.

ITEM	COLOR	BLADE LENGTH		PACK
		IN	CM	
PC1286RD	Red	6	15.2	6
PC1286TN	Tan	6	15.2	6
PC1286YL	Yellow	6	15.2	6



COLORCODE SPATULA

Now cross-contamination protection moves to the grill. Each of the four specialty spatulas are color-coded for their specific use.

ITEM	DESCRIPTION	BLADE		O/A LENGTH		PACK
		IN	CM	IN	CM	
PC1290YL	Yellow Spatula	8 x 2 7/8	20.3 x 7.3	14 3/4	37.5	12
PC1280GR	Green Spatula	8 x 2 7/8	20.3 x 7.3	14 3/4	37.5	12
PC233HTRD	Red Turner	5 x 2 7/8	12.7 x 7.3	11 1/2	29.2	12
PC219PRD	Red Spatula	7 3/8 x 2 7/8	18.7 x 7.3	14 3/4	37.5	12



P.O.P. Packaging

ColorCode knives are available individually packaged for P.O.P display. Clam shell increases safety in handling, but also available in bulk pack. Specify item number for bulk pack or clam shell when ordering.



Brown ABS Handle Knives

Strong molybdenum stainless steel blades and well-balanced ABS handles are made to provide many years of heavy commercial service.



PC15312

SCIMITAR KNIFE

ITEM	BLADE LENGTH		PACK
	IN	CM	
PC15310	10	25.4	6
PC15312	12	30.5	6



PC15412

SLICER

ITEM	BLADE LENGTH		PACK
	IN	CM	
PC15410	10	25.4	6
PC15412	12	30.5	6
PC15414	14	35.6	6



PC12625

PARING KNIFE

ITEM	BLADE LENGTH		PACK
	IN	CM	
PC12625	3	7.6	6



PC1276C



PC1286



PC1286N

BONING KNIVES

ITEM	DESCRIPTION	BLADE LENGTH		PACK
		IN	CM	
PC1276C	Curved	6	15.2	6
PC1286	Stiff	6	15.2	6
PC1286N	Flexible/Narrow	6	15.2	6



COOK'S KNIFE

ITEM	BLADE LENGTH		PACK
	IN	CM	
PC1298	8	20.3	6
PC12910	10	25.4	6
PC12912	12	30.5	6



PC15612

BUTCHER KNIFE

ITEM	BLADE LENGTH		PACK
	IN	CM	
PC15610	10	25.4	6
PC15612	12	30.5	6



PC15512

BREAD SLICER

ITEM	BLADE LENGTH		PACK
	IN	CM	
PC15510	10	25.4	6
PC15512	12	30.5	6



BUTCHER STEELS

Tempered steel with a magnetized, fine cut that retains knife particles.

ITEM	BLADE LENGTH		PACK
	IN	CM	
PC12010	10	25.4	6
PC12012	12	30.5	6
PC12014	14	35.6	6

ColorCode System Knives II*

A value line of cutlery made from German stainless steel with a polypropylene handle. Each knife is individually clam shell packed for point of purchase display. NSF listed.

 All items on this page are part of our economy line offerings, identified by our green e-line icon and matching color-coded chart items.



COOK'S KNIFE

ColorCode handles correspond to their specific food group to avoid cross-contamination: use blue for cooked foods, green for fruits and vegetables, red for meat, tan for fish and seafood, white for dairy products, yellow for poultry, and purple for allergen-free. Blades are made from rigid molybdenum stainless steel.



ITEM	BLADE LENGTH		ITEM	BLADE LENGTH		COLOR	PACK
	IN	CM		IN	CM		
 PC12910BLCH	10	25.4	PC12912BLCH	12	30.5	Blue	6
PC12910GRCH	10	25.4	PC12912GRCH	12	30.5	Green	6
PC12910RDCH	10	25.4	PC12912RDCH	12	30.5	Red	6
PC12910PLCH	10	25.4				Purple	6
PC12910TNCH	10	25.4	PC12912TNCH	12	30.5	Tan	6
PC12910WHCH	10	25.4	PC12912WHCH	12	30.5	White	6
PC12910YLCH	10	25.4	PC12912YLCH	12	30.5	Yellow	6



ASSORTED PARING KNIVES

24 piece P.O.P. display box contains 6 each of red, green, white and black color handled knives.

ITEM	BLADE LENGTH		PACK
	IN	CM	
 PC12625AST	3 1/4	8.3	1 box



BONING KNIFE

ColorCode knives are also available with a 6" blade for boning.

ITEM	COLOR	BLADE LENGTH		PACK
		IN	CM	
 PC1286RDCH	Red	6	15.2	6
PC1286TNCH	Tan	6	15.2	6
PC1286YLCH	Yellow	6	15.2	6



*In addition to the ColorCode system knives, Alegacy offers a complete line of cutlery with a white polypropylene handle. See pages 156-157.



Knives

A value line of cutlery made from German stainless steel with a polypropylene handle. Each knife is individually clam shell packed for point of purchase display. NSF listed.



PC15510CH

BREAD KNIFE

ITEM	BLADE LENGTH		PACK
	IN	CM	
 PC15510CH	10	25.4	6
PC15512CH	12	30.5	6



PARING KNIFE

ITEM	BLADE LENGTH		PACK
	IN	CM	
 PC12625CH	3	7.6	6



PC12910CH

COOK'S KNIFE

ITEM	BLADE LENGTH		PACK
	IN	CM	
 PC1298CH	8	20.3	6
PC12910CH	10	25.4	6
PC12912CH	12	30.5	6



PC1286NCH



PC1276CCH



PC1286CH

BONING KNIFE

ITEM	DESCRIPTION	BLADE LENGTH		PACK
		IN	CM	
 PC1276CCH	Curved	6	15.2	6
PC1286CH	Wide	6	15.2	6
PC1286NCH	Narrow	6	15.2	6



PC15412CH

SLICER

ITEM	BLADE LENGTH		PACK
	IN	CM	
 PC15410CH	10	25.4	6
PC15412CH	12	30.5	6
PC15414CH	14	35.6	6



PC1217CH

CLEAVER

ITEM	BLADE LENGTH		PACK
	IN	CM	
 PC1216CH	6	15.2	6
PC1217CH	7	17.8	6
PC1218CH	8	20.3	6
PC1219CH	9	22.9	6

 All items on this page are part of our economy line offerings, identified by our green e-line icon and matching color-coded chart items.

Polypropolene White Handle Cutlery & Spatulas

The ColorCode System Knives I and II are complemented by a variety of knives and spatulas with a white handle for utility use in the busy commercial kitchen. Each product is individually clam shell packed for point of purchase display. NSF listed.



SANTOKU GRANTON KNIFE

ITEM	BLADE LENGTH		
	IN	CM	PACK
 PC1527WHCH	7	17.8	6



PARING KNIFE

ITEM	BLADE LENGTH		
	IN	CM	PACK
 PC12625WHCH	3 1/4	8.3	6



BONING KNIVES

ITEM	BLADE LENGTH		
	IN	CM	PACK
 PC1286WHCH	6	15.2	6
PC1276WHCH	6	15.2	6



SLICER

ITEM	BLADE LENGTH		
	IN	CM	PACK
 PC15412WHCH	12	30.5	6



BREAD SLICER

ITEM	LENGTH		
	IN	CM	PACK
 PC1558WHCH	8	20.3	6
PC1559WHCH	9	22.9	6



PC10SP14WCH

ICING SPATULAS

ITEM	BLADE		O/A LENGTH		
	IN	CM	IN	CM	PACK
 PC10SP425WHCH	4 1/4 x 1 3/4	11.4 x 1.9	8 1/2	21.6	12
PC10SP6WHCH	6 x 1	15.2 x 2.5	10 1/8	25.7	12
PC10SP8WHCH	8 x 1 1/4	20.3 x 3.2	13	33	12
PC10SP10WHCH	10 x 1 1/2	25.4 x 3.8	14 1/2	36.8	12
PC10SP12WHCH	12 x 1 1/3	30.5 x 4.4	16 3/4	42.5	12
PC10SP14WHCH	14 x 1 3/4	35.6 x 4.4	19	48.3	12



OFFSET ICING SPATULAS

ITEM	BLADE		O/A LENGTH		
	IN	CM	IN	CM	PACK
 PCOS10SP425WHCH	4 1/4 x 3/4	11.4 x 1.9	8 1/2	21.6	12
PCOS10SP6WHCH	6 x 1	15.2 x 2.5	10 1/8	25.7	12
PCOS10SP8WHCH	8 x 1 1/4	20.3 x 3.2	13	33	12
PCOS10SP10WHCH	10 x 1 1/2	25.4 x 3.8	14 1/2	36.8	12
PCOS10SP12WHCH	12 x 1 3/4	30.5 x 4.4	16 3/4	42.5	12
PCOS10SP14WHCH	14 x 1 3/4	35.6 x 4.4	19	48.3	12

 All items on this page are part of our economy line offerings, identified by our green e-line icon and matching color-coded chart items.



e™ All items on this page are part of our economy line offerings, identified by our green e-line icon and matching color-coded chart items.



PC1280WHCH



SANDWICH SPREADER

ITEM	BLADE LENGTH		O/A LENGTH		PACK
	IN	CM	IN	CM	
e ™ PC288WHCH	7 3/4	19.7			12

SPATULAS

ITEM	DESCRIPTION	BLADE LENGTH		O/A LENGTH		PACK
		IN	CM	IN	CM	
e ™ PC1280WHCH	Spatula	8 x 3	20.3 x 7.6	14 1/2	36.8	12
PC219PWCH	Perforated Spatula	8 x 3	20.3 x 7.6	14 1/2	36.8	12
PC2013WHCH	Grill Scraper	4	10.2	9 1/2	24.1	12



PC56WHCH



TURNERS

ITEM	BLADE LENGTH		O/A LENGTH		
	IN	CM	IN	CM	PACK
e ™ PC54WHCH	5 1/2 x 4 1/2	14 x 11.4	11 3/4	29.8	12
PC56WHCH	5 x 6	15.2 x 12.7	13	33	12



PIE SERVER

ITEM	BLADE LENGTH		O/A LENGTH		PACK
	IN	CM	IN	CM	
e ™ PC25WHCH	5	12.7	10	25.4	12



UTILITY SPATULA

ITEM	BLADE LENGTH		O/A LENGTH		PACK
	IN	CM	IN	CM	
e ™ PC24WHCH	4 1/2 x 3	11.4 x 7.6	11	27.9	12



DOUGH SCRAPER

ITEM	BLADE LENGTH		PACK
	IN	CM	
e ™ PC182WHCH	6 X 3	15.2 X 7.6	12



FISH SPATULA

ITEM	BLADE LENGTH		O/A LENGTH		PACK
	IN	CM	IN	CM	
e ™ PC1517WHCH	7	17.8	11 1/2	29.2	12



UTILITY SPATULA

All-purpose spatula with wooden handle.

ITEM	BLADE		O/A LENGTH		PACK
	IN	CM	IN	CM	
AL24S	2 1/2 x 2 1/4	6.4 x 5.7	7 1/2	19.1	12



ICING SPATULAS

Stainless steel blade with hardwood handle.

ITEM	BLADE		O/A LENGTH		PACK
	IN	CM	IN	CM	
15056	6 1/2 x 1	16.5 x 2.5	11 1/4	28.6	12
15058	8 x 1	20.3 x 2.5	13 1/4	33.7	12
150510	10 x 1 1/2	25.4 x 3.8	14 1/2	36.8	12
150512	12 x 1 3/4	30.5 x 4.4	17 1/4	43.8	12



STAINLESS STEEL TURNER

All 18/8 stainless steel with a satin finish.

ITEM	DESCRIPTION	BLADE		O/A LENGTH		PACK
		IN	CM	IN	CM	
1436	Solid	6	15.2	14	35.6	12
1437	Perforated	6	15.2	14	35.6	12



SPECIALTY TURNER

Stainless steel blades with hardwood handles.

ITEM	DESCRIPTION	BLADE		O/A LENGTH		PACK
		IN	CM	IN	CM	
44	Long Handle	8 x 3	20.3 x 7.6	20	50.8	12



TURNERS

Stainless steel blades with hardwood handles. Now available in a variety of "EH" models with an extra thick blade.

ITEM	DESCRIPTION	BLADE		O/A LENGTH		PACK
		IN	CM	IN	CM	
219P	Perforated	8 x 3	20.3 x 7.6	14 1/2	36.8	12
219PEH	Perforated	8 x 3	20.3 x 7.6	14 1/2	36.8	12
AL1280	Stiff	8 x 3	20.3 x 7.6	14 1/2	36.8	12
AL1290	Flexible	8 x 3	20.3 x 7.6	14 1/2	36.8	12
AL1290EH	Flexible	8 x 3	20.3 x 7.6	14 1/2	36.8	12



233HT

SQUARE TURNER

Stainless steel blades with hardwood handles.

ITEM	BLADE		O/A LENGTH		PACK
	IN	CM	IN	CM	
SQ1280	7 3/8 x 3	18.7 x 7.6	13 1/2	34.3	12
233HT	5 x 2 3/4	12.7 x 7	11 1/4	28.6	12



TURNER

"Super-grade," extra-weight turner with a mirror polish.

ITEM	BLADE		O/A LENGTH		PACK
	IN	CM	IN	CM	
56	5 x 6	12.7 x 15.2	13	33	12



OFFSET SPATULA

Hardwood handle with flexible stainless steel blade.

ITEM	BLADE		O/A LENGTH		
	IN	CM	IN	CM	PACK
AL26S	4 1/2 x 2 1/4	11.4 x 5.7	10	25.4	12

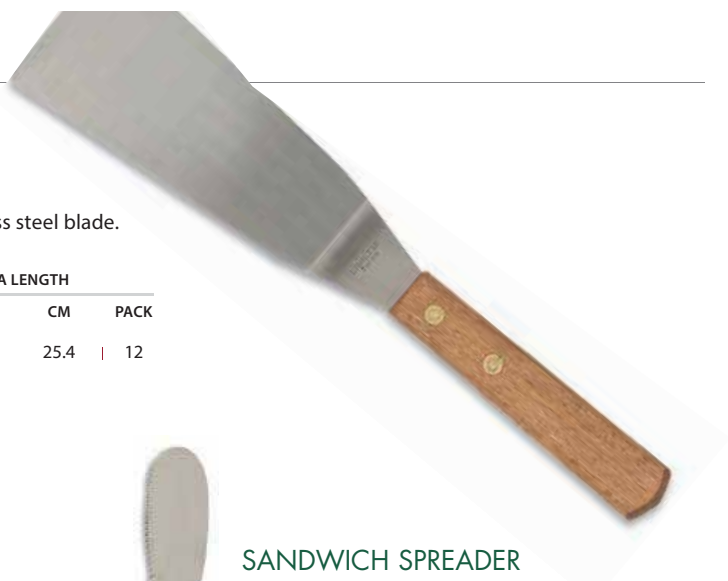

GRILL SCRAPER

3" (7.6 cm) wide carbon steel blade with a wooden handle.

ITEM	O/A LENGTH		
	IN	CM	PACK
2013	9 1/8	23.2	12



SANDWICH SPREADER

Deluxe wooden handle spreader with a heavy gauge stainless steel serrated blade.

ITEM	O/A LENGTH		
	IN	CM	PACK
AL288S	7 3/8	18.7	12



PIE SERVER

Flexible, offset stainless steel blade.

ITEM	BLADE		O/A LENGTH		
	IN	CM	IN	CM	PACK
AL25S	5 1/2	14	10	25.4	12

STAINLESS STEEL TURNER – PLASTIC HANDLE

All stainless steel blades with brown, ABS plastic handles.

ITEM	DESCRIPTION	BLADE		O/A LENGTH		
		IN	CM	IN	CM	PACK
PC1280	Stiff Turner	8 x 2 3/4	20.3 x 7	14 3/4	37.5	12
PC219P	Perf. Turner	8 x 2 3/4	20.3 x 7	15	38.1	12
PC233HT	Stiff Turner	4 3/4 x 2 3/4	12 x 7	11 1/2	29.2	12



ICING SPATULAS

Molybdenum stainless blade with a brown, ABS plastic handle.

ITEM	BLADE		O/A LENGTH		
	IN	CM	IN	CM	PACK
PC10SP6	6	15.2	11	27.9	12
PC10SP8	8	20.3	13	33	12
PC10SP10	10	25.4	15 1/4	38.7	12
PC10SP12	12	30.5	17 1/4	43.8	12
PC10SP14	14	35.5	19 1/4	48.9	12

STAINLESS STEEL BLADES – PLASTIC HANDLE

All stainless steel blades with brown, ABS plastic handles.

ITEM	DESCRIPTION	BLADE		O/A LENGTH		
		IN	CM	IN	CM	PACK
PC2013	Stiff Scraper	4 1/2 x 3	11.4 x 7.6	10	25.4	12
PC25S	Pie Server	6	15.2	11	27.9	12
PC288S	Serrd. Spreader	4 3/8	11.1	9 1/2	24.1	12



PC288S



PC25S

*Blade dimension on angled turners is for the flat part only.

CLEAVERS

Molybdenum stainless blades with brown, ABS plastic handles.



PC1216



PC1217



PC1218



PC1219



PC12110

ITEM	BLADE LENGTH		PACK
	IN	CM	
PC1216	6	15.2	6
PC1217	7	17.8	6
PC1218	8	20.3	6
PC1219	9	22.9	6
PC12110	10	25.4	6

COOK'S FORK

Stainless steel with a forged, hardwood handle.

ITEM	O/A LENGTH		
	IN	CM	PACK
4441	12	30.5	6
5551	14	35.6	6



POT FORK

Stainless steel with a rosewood handle.

ITEM	O/A LENGTH		
	IN	CM	PACK
222S	12	30.5	12



CAMP FORK

Stainless steel with a beechwood handle.

ITEM	O/A LENGTH		
	IN	CM	PACK
AL2380	21	53.3	12



MEAT HOOKS

Stainless steel construction well suited for processing of meats.

ITEM	LENGTH		PACK
	IN	CM	
MHSS6	2 ½	5.9	12
MHSS8	3 ½	8.9	12
MHSS10	4	10.2	12
MHSS12	5 ¼	13.3	12
MHSS14	5 ¾	14.6	12
MHSS16	6 ½	16.5	12
MHSS18	7 ¼	18.4	12
MHSS20	7 ¾	20	12
MHSS22	8 ¾	22.2	12



OYSTER KNIFE

Plastic handle knife is for opening oyster shells.

ITEM	DESCRIPTION	BLADE LENGTH		
		IN	CM	PACK
5030PH	w/ Blue Handle	3	7.6	12





STEAK KNIFE

Stainless steel blade with full wave cut.

ITEM	DESCRIPTION	BLADE LENGTH		PACK
		IN	CM	
SK17	Hardwood Handle	4 1/8	10.5	24

HOLLOW GROUND STEAK KNIVES

Stainless steel blades with a full wave cut.

ITEM	DESCRIPTION	BLADE LENGTH		PACK
		IN	CM	
741HG	Pakka Wood Handle	3 1/2	8.9	24
742HG	Hardwood Handle	3 1/2	8.9	24
SK16	Hardwood Handle	4 3/4	12.1	24
SK15	ABS Plastic Handle	5	12.7	12



STEAK KNIFE

Stainless steel blade with full wave cut.

ITEM	DESCRIPTION	BLADE LENGTH		PACK
		IN	CM	
841HG	Full Tang Blade	4	10.2	12



STEAK KNIFE

Hollow ground blade with a waverly edge.

ITEM	DESCRIPTION	BLADE LENGTH		PACK
		IN	CM	
220304	Hardwood Handle	4 1/8	10.5	24

STEAK KNIFE

Hollow ground blade with a waverly edge.
Rosewood polywood handle.

ITEM	DESCRIPTION	BLADE LENGTH		PACK
		IN	CM	
283104	Rounded Tip	4 1/8	10.5	24



JUMBO STEAK KNIFE

Stainless steel blade with hardwood handle.

ITEM	DESCRIPTION	BLADE LENGTH		PACK
		IN	CM	
220605	Rounded Tip	5	12.7	12



FRUIT KNIFE

Stainless steel blade with a milled edge and a hardwood handle.

ITEM	BLADE LENGTH		PACK
	IN	CM	
305	4	10.2	12



OYSTER KNIFE

5005 is New Haven style with a hardwood handle. 5000 is professional style with a hardwood handle. Used for opening oyster shells and removing the meat.

ITEM	BLADE LENGTH		PACK
	IN	CM	
5005	4	10.2	12
5000	3	7.6	12

PARING KNIFE

Wooden handle with stainless steel blade.

ITEM	BLADE LENGTH		PACK
	IN	CM	
424PK	3	7.6	12



CLAM KNIFE

Heavy steel blade with a hardwood handle. Used for opening clam shells.

ITEM	BLADE LENGTH		PACK
	IN	CM	
5020	3 1/2	8.9	12

COMBINATION STONE

Made from aluminum oxide, this is unlike any artificial stone in speed of cutting, long life, and smoothness of resulting edge on tool.

ITEM	IN	CM	PACK
5621	6 x 2 x 1	15.2 x 5.1 x 2.5	1
5821	8 x 2 x 1	20.3 x 5.1 x 2.5	1



SHARPENING STONE

Finest quality silicon carbide stones for general sharpening of edges on hand tools and cutlery.

ITEM	IN	CM	PACK
821CH	8 x 2 x 1	20.3 x 5.1 x 2.5	1



ALEGACY KNIFE SHARPENER

This precision instrument is faster and surer than an oilstone. The guide adjusts knife blade to abrasive wheel at the proper angle while the synchronized action of blade and wheel eliminates wavy and jagged edges. Replacement stones and parts are available.

ITEM	DESCRIPTION	IN	CM	PACK
800KS	Unit	5 x 3 x 4 3/4	12.7 x 7.6 x 12.1	1
800HR	Head/800KS			1
800RS	Stone/800KS			1



SHARPENING STONE

This extra large stone has a coarse side for fast sharpening and a fine side for a finished edge.

STONE DIMENSIONS				
ITEM	DESCRIPTION	IN	CM	PACK
1121	Refill Stone	11 1/2 x 2 1/2 x 1	29.2 x 6.4 x 2.5	1

SHARPENING STONE OIL

Free flowing with plenty of body to float the particles of steel removed from the edge in honing, thus preventing glazing.



ITEM	CAN SIZE	PACK
XB1	4 1/2 fl oz (.13 L)	1
XB5	1 pint (.47 L)	1
XB2	1 quart (.95 L)	1



SHARPENING STONE WITH HANDLE

Silicon carbide abrasive, coarse and fine, vitrified. The coarse side brings a dull trimming knife to an edge quickly, while the fine side produces a perfect edge for cutting leather or rubber.

LENGTH			
ITEM	IN	CM	PACK
1475H	15	38.1	1



TRIPLE STONE (SHARPENING STONE)

Furnished in a durable plastic case with three stones-coarse, medium, and fine. Ideal for all straight edge tools and its full size permits a full sweeping stroke. Stones are reversible and immersed in oil when not in use.

ITEM	IN	CM	PACK
963	19 1/2 x 5 1/2 x 4 1/2	49.5 x 14 x 11.4	1

TRIPLE OILSTONE REPLACEMENT

ITEM	DESCRIPTION	IN	CM	PACK
1122F	Fine	11 1/2 x 2 1/2 x 1/2	29.2 x 6.4 x 1.3	1
1123M	Medium	11 1/2 x 2 1/2 x 1/2	29.2 x 6.4 x 1.3	1
1124C	Coarse	11 1/2 x 2 1/2 x 1/2	29.2 x 6.4 x 1.3	1



PATTY MOLD MACHINE

Parts List for HM45 & HM69

ITEM	DESCRIPTION
M1	Mold Plate 6 to 9 Patties per lb (HM69)
M2	Mold Plate 4 to 5 Patties per lb (HM45)
M4	Handle
M5	Base
M6	Cloth Liner Bar
M7	Spring
M8	Mold Screw
M9	Hinge Pin
M10PHP	Paper Molding Pins
M11	Stripper Bar w/ Nut and Washer
M12	Set Screw
M13	Block
M14	Cloth Liners

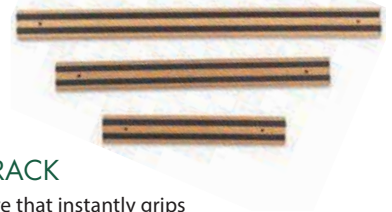

MAGNETIC KNIFE RACK

A quality import alternative that instantly grips and releases knives and utensils. Permanent magnetism, no moving parts.

ITEM	IN	CM	PACK
MTH12	12	30.5	12
MTH18	18	45.7	12
MTH24	24	60.9	12



KNIFE RACK

Stainless steel construction holds up to ten knives, two butcher steels, and two cleavers. Can be mounted to a wall, counter or table.

ITEM	IN	CM	PACK
AKP321	12 x 12 7/8 x 2 1/2	30.5 x 32.7 x 6.35	1



PATTY MOLDING MACHINE

Forms and ejects wax-sheeted patty in one operation. The body is polished, die-cast aluminum. Holds up to 100 sheets and the mold and knockout discs are interchangeable.

ITEM	DESCRIPTION	IN	CM	PACK
HM45	4-5 Patties/lb	12 1/4 x 7 3/4 x 5 1/2	31.1 x 19.7 x 14	1
HM69	6-9 Patties/lb	12 1/4 x 7 3/4 x 5 1/2	31.1 x 19.7 x 14	1

ALEGACY PATTY PAPER

Punched with two spindle holes to fit all mold sizes with a sheet size of 5 3/16 x 5 3/16" (13.2 cm x 13.2 cm). Divides hamburger patties.



ITEM	PACK
A5HP	12,000/cs (Sold in Case Pack Only)



HAMBURGER PRESS

Makes uniform hamburger patties every time. Die-cast, polished finish of non-rusting aluminum alloy. 4450HP is an adjustable unit.

ITEM	PATTY SIZE		DIAMETER		PACK
	IN	CM	IN	CM	
3450HP	4 5/8	11.7	5	12.7	1
4450HP	4 5/8	11.7	4 3/4	12.1	1



UTILITY PAIL

For a variety of kitchen prep and cleanup activities, this 18/8 stainless steel pail is ideal.

ITEM	TOP DIAMETER		HEIGHT		PACK
	IN	CM	IN	CM	
UP1	12 1/2	31.7	10 1/4	26	1



STAINLESS STEEL MIXING PADDLE

Virtually indestructible, polished, 18/8 stainless steel. For mixing dough or use in larger size stock pots.

ITEM	O/A LENGTH		BLADE		PACK
	IN	CM	IN	CM	
19924	24	60.9	4 1/2 x 8	11.4 x 20.3	1
19930	30	76.2	4 1/2 x 8	11.4 x 20.3	1
19936	36	91.4	4 1/2 x 8	11.4 x 20.3	1
19942	42	106.7	4 1/2 x 8	11.4 x 20.3	1
19948	48	121.9	4 1/2 x 8	11.4 x 20.3	1
19954	54	137.2	4 1/2 x 8	11.4 x 20.3	1
19960	60	152.4	4 1/2 x 8	11.4 x 20.3	1



WOODEN MIXING PADDLE

Paddles are sanded, smooth, seasoned hardwood. For mixing pizza and bread dough.

ITEM	O/A LENGTH		BLADE		PACK
	IN	CM	IN	CM	
9918MP	18	45.7	3 x 6	7.6 x 15.2	12
9920MP	20	50.8	3 x 6	7.6 x 15.2	12
9924MP	24	60.9	3 1/4 x 6	8.2 x 15.2	12
9930	30	76.2	3 1/4 x 6	8.2 x 15.2	12
9936	36	91.4	3 1/4 x 6	8.2 x 15.2	12
9942	42	106.7	3 1/4 x 6	8.2 x 15.2	12
9948	48	121.9	3 1/4 x 6	8.2 x 15.2	12
9954	54	137.2	3 1/4 x 6	8.2 x 15.2	12
9960	60	152.4	3 1/4 x 6	8.2 x 15.2	12



ROUND EGG MOLD

Well-balanced handle will not transfer heat while frying eggs on a griddle. Chrome-plated, half-round wire construction.

ITEM	DIAMETER		HEIGHT		PACK
	IN	CM	IN	CM	
3804	3 7/8	9.8	3/8	1	12



EGG RINGS

Stainless steel rings used for basting. Handles are made to minimize heat transfer and feature an eye for hanging.

ITEM	DESCRIPTION	DIAMETER		DEPTH		PACK
		IN	CM	IN	CM	
3805	Round Ring	6	15.2	1	2.5	12
3825	Round Ring	5 1/8	13.1	1	2.5	12
3806	Square Ring	4 x 4	10.2 x 10.2	1	2.5	12



POULTRY SHEAR

Forged steel with plated blades and painted grips.

ITEM	LENGTH		
	IN	CM	PACK
1214	8 1/2	21.6	12



FISH & POULTRY SHEAR

Polished, forged steel, spring operated with a built-in bone crusher.

ITEM	LENGTH		
	IN	CM	PACK
1213	9 1/2	24.1	12



SHRIMP MASTER

Sturdy styrene plastic with stainless steel tips. The positive spring action removes shells and de-veins shrimp.

ITEM	LENGTH		
	IN	CM	PACK
6100	8 1/2	21.6	12



STEEL POULTRY SHEARS

Made of forged steel, the poultry shear is spring operated and has a built-in bone crusher. Can also be used for fish.

ITEM	DESCRIPTION	LENGTH		PACK
		IN	CM	
1219	Chromed Steel	9 1/2	24.1	12
1220	Stainless Steel	10 1/2	26.1	12



FORGED STEEL POULTRY SHEAR

ITEM	LENGTH		
	IN	CM	PACK
1217	7 1/2	19.1	12



CAST IRON SKILLETS

Strong handle and molded rim allow for easy pouring.
Low wall keeps temperatures even.

ITEM	DIAMETER		DEPTH		PACK
	IN	CM	IN	CM	
SK3	6 1/2	16.5	1 1/4	3.2	6
SK5	8	20.3	1 3/4	4.4	6
SK6	8 3/4	22.2	1 3/4	4.4	6
SK8	10 1/2	26.7	2	5.1	6
SK10	12 1/4	31.1	2	5.1	6
SK12	13 1/4	33.7	2 1/4	5.7	3
SK14	15 1/4	38.7	2 1/4	5.7	3



DO8

DO10

CAST IRON DUTCH OVEN

Bakes vegetables and roasts perfectly. Two sizes available for small or large roasts.

ITEM	CAPACITY		DIAMETER		DEPTH		PACK
	QT	L	IN	CM	IN	CM	
DO8	5	4.7	10 1/4	26	4	10.2	1
DO10	7	6.6	12	30.5	4 3/4	12.1	1



CF8

CAST IRON CHICKEN FRYER

Chicken is perfectly browned with great flavor when cooked in a traditional cast iron fry pan.

ITEM	CAPACITY		DIAMETER		DEPTH		PACK
	QT	L	IN	CM	IN	CM	
CF8	3	2.3	10 1/4	26	3	7.6	1



CLAM STEAMER

Complete with cover, upper and lower pot, and faucet.
Blue enameled steel, inside and out. Capable of steaming four dozen small clams or four 1 lb (.5 kg) lobsters.

ITEM	DIAMETER		O/A HEIGHT		TOP HEIGHT		BOTTOM HEIGHT		PACK
	IN	CM	IN	CM	IN	CM	IN	CM	
27	12	30.5	17	43.2	9 ³ / ₄	24.8	6	15.2	1

CAST IRON ROUND GRIDDLE

Great for pancakes, frying bacon or eggs.
Also excellent for preparing and serving fajitas.

ITEM	DIAMETER		DEPTH		PACK
	IN	CM	IN	CM	
RG9	10 ¹ / ₄	26	1/4	.6	6



CAST IRON CORN STICK PAN

Bakes corn-cob shaped cornbread that does not stick to special surface of pans.

ITEM	STICKS	IN	CM	PACK
CP527	5	9 ¹ / ₈ x 5 ¹ / ₂	23.2 x 14	6
CP27	7	12 ³ / ₈ x 5 ¹ / ₂	31.4 x 14	6



TOMATO SLICER

Prepares perfect tomato slices, quickly and safely. Can also be used to slice strawberries and mushrooms in a high volume commercial operation. Positive stop arm.

ITEM	IN	CM	PACK
75870	19 x 10 x 9 3/4	48.3 x 25.4 x 24.8	1



TOMATO SLICER- BLADE ONLY

ITEM	LENGTH		PACK
	IN	CM	
75870B	11 1/2 x 3	29.2 x 7.6	1



GRILL SCREEN HOLDER

Use this metal holder to protect your hands and provide even pressure on the grill. The clamp action holds the grill screen securely and permits easy changing.

ITEM	IN	CM	PACK
3300	5 x 3	12.7 x 7.6	12



GRILL CLEANER SCREEN

Strong, flexible mesh is covered on both sides with sharp, abrasive grains. Use them to quickly cut away even the most stubborn burned spots. They are easy to use: just pour a little grease on the warm grill, hold the screen down on the grill with the holder to protect your hand, and rub briskly, but lightly. Wipe with a clean cloth to see your grill sparkle once again.

ITEM	SHEETS PER ENVELOPE	IN	CM	ENVELOPES PER CASE
3100EP	8	4 1/2 x 5 1/2	11.4 x 14	50



MEAT CHOPPER

Heavy-duty meat chopper makes ground beef, other ground meats, and more. Furnished with a 3/16" (.5 cm) plate.

ITEM	DESCRIPTION	PLATE DIAMETER		PACK
		IN	CM	
MC10	Standard	2 1/2	6.4	1
MC32	Heavy-Duty	3 3/4	9.5	1

SUNKIST ELECTRIC JUICER

Make fresh juices every day with the Sunkist electric juicer. Juicer has a 1 1/4 hp motor with a non-corroding switch, 1750 RPM for clean, smooth reaming and sealed, lifetime bearings. Unit is 17" (43.2 cm) high by 8" (20.3 cm) in diameter. UL listed.

ITEM	CURRENT	PACK
8J	115V/50C	1
8J230-50	230V/50C	1
8J230-60	230V/60C	1



8J



75861



75858

MANUAL JUICERS

Sturdy commercial tabletop juicers make juice production fast and easy. Makes more juice with less waste from a citrus half. Available in black enamel finish with cast aluminum and porcelain components (#75861) or in a chrome-plated body with an 18/8 stainless steel juicer cup (#75858).

ITEM	DESCRIPTION	IN	CM	PACK
75858	Small Deluxe	5 x 7 x 19	12.7 x 17.8 x 48.3	1
75861	Large Heavy-Duty	7 x 9 x 23	17.8 x 22.9 x 58.4	1



ALEGACY FRENCH FRY CUTTER

Heavy-duty cast body, cast iron handle, and stainless steel trough. The frame, pusher block, and cutting frame are all rust proof. Has a capacity of potatoes 6" (15.2 cm) long and up to 50 lb (22.7 kg) of potatoes per hour. Can be wall or table mounted.

ITEM	DESCRIPTION	PACK
A250	1/4" (.6 cm) Cut	1
A375	3/8" (1 cm) Cut	1
A500	1/2" (1.3 cm) Cut	1



FRENCH FRY CUTTER PARTS LIST

ITEM	DESCRIPTION
A1	Handle
A2	Bolt Nut and Screw
A3	Front End Casting
A4	Wing Nut
A5	Slide Rod
A6	Slide Rod Nut
A7C	Back End Casting
A8L	Link Connector Screw & Nut
A9P	Potato Pusher
A10P	Pusher Connector Casting
A11P	Pusher Connector Screw
A12P	Pusher Block Screw
A13L	Link
A14B	Blade Locking Screw
A15C	1/4" (.6 cm) Cutting Frame
A15S	3/8" (.9 cm) Cutting Frame
A15F	1/2" (1.3 cm) Cutting Frame
A16S	3/8" (.9 cm) Pusher Block
A16C	1/4" (.6 cm) Pusher Block
A16F	1/2" (1.3 cm) Pusher Block
A17T	Tray

ALEGACY POTATO WEDGE CUTTER

Saves time and money with fast, one-step cutting. Makes potato wedges, french fries, and more with accessory attachments available.

ITEM	DESCRIPTION	PACK
ALW6	6 Cut Wedge Shape	1
ALW8	8 Cut Wedge Shape	1

WEDGE CUTTER PARTS

ITEM	DESCRIPTION	PACK
ALW6C	Wedge Cutter, 6 Cut	1
ALW6P	Pusher Block, 6 Cut	1
ALW8C	Wedge Cutter, 8 Cut	1
ALW8P	Pusher Block, 8 Cut	1

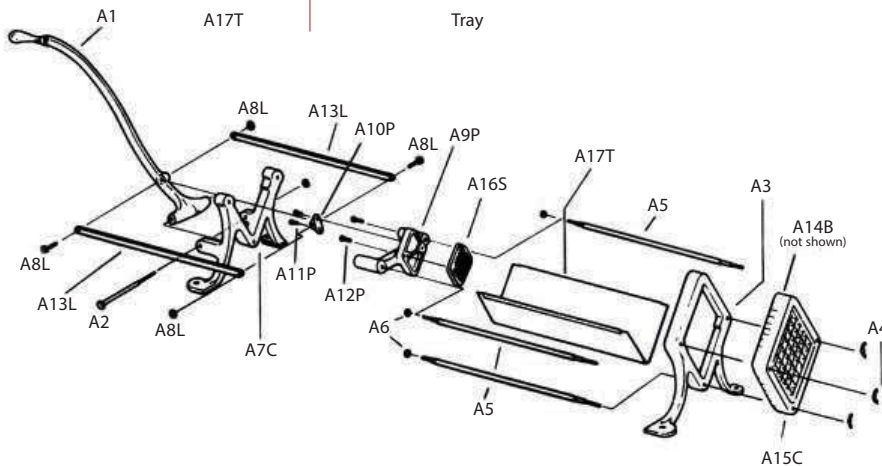



FFB20L

FRENCH FRY BAGGER

Convenient right handed, left handed, and dual models provide for easy collecting and bagging of french fries. Made of 18/8 stainless steel with a bakelite handle. Also available in plastic.



PFFB10R

DIMENSIONS (D X H)

ITEM	IN	CM	PACK
 FFB10R	9 X 8	22.9 X 20.3	12
FFB20L	9 X 8	22.9 X 20.3	12
FFB30D	9 X 8	22.9 X 20.3	12
PFFB10R	9 X 8	22.9 X 20.3	12
PFFB20L	9 X 8	22.9 X 20.3	12
PFFB30D	9 X 8	22.9 X 20.3	12



FFB30D



NOODLE CUTTER

This table mounted pasta machine cuts noodles as fine as angel hair, or as wide as lasagna. Stainless steel body disassembles easily for cleaning. Furnished with a fine and medium roller and a table clamp.

ITEM	IN	CM	PACK
12151	7 1/2 x 7 1/2 x 5	19.1 x 19.1 x 12.7	1

HAND CHEESE GRATER

Hand held cheese grater is made to withstand the rigors of frequent use in the kitchen or at tableside.

ITEM	IN	CM	PACK
72667	5 1/2 x 3 3/8 x 3 1/4	13.9 x 8.6 x 8.3	1



Portion Control Scales

Accuracy, durability, and versatility carry equal weight with all Alegacy portion control scales. A consistent, dependable reading will ensure the most efficient preparation. Scales range from an 1/8 ounce sensitivity all the way up to a 200 pound capacity, to provide the solutions your food preparation requires.

PORTION CONTROL SCALES

All models have a 6" (15.2 cm) dial face with a shatterproof lens, adjusting knob, and temperature compensated mechanisms. Choose a body finish of stainless steel or enamel. Base dimension is 7 1/4 x 5 1/4 x 7 1/2" (18.4 x 13.3 x 19 cm), platforms measure 5 3/4 x 5 3/4 (14.6 x 14.6 cm) or 5 3/4 x 7 7/8" (14.6 x 20 cm) for 25 lb (55.1 kg) models.



74861



74882

ITEM	CAPACITY		INCREMENT		BODY FINISH	DIAL TYPE	PACK
	LB	KG	OZ	G			
74858	5	2.3	1/2	14.2	S/S	Rotating	1
74861	25	11.3	2	56.7	S/S	Rotating	1
74864	*	500 g	-	2	S/S	Rotating	1
74867	2	.9	1/4	7.1	Enamel	Fixed	1
74870	5	2.3	1/2	4.2	Enamel	Fixed	1
74873	25	11.3	2	56.7	Enamel	Fixed	1

*Dial face reads in grams only

PORTION CONTROL SCALES

Alegacy offers quality portion control with the an 8" (20.3 cm) zero adjusting dial. Base dimension is 10 1/2 x 10 1/2 x 7 1/8" (26.7 x 26.7 x 18.1 cm).

ITEM	CAPACITY		INCREMENT		BODY FINISH	DIAL TYPE	PACK
	LB	KG	OZ	G			
74879	5	2.2	1/2	10	Enamel	Fixed	1
74882	11	5	1	25	Enamel	Fixed	1
74885	20	9	1	25	Enamel	Fixed	1

PORTION CONTROL SCALES

All models have a 6" (15.2 cm) dial face with a shatterproof lens, adjusting knob, and temperature compensated mechanisms. Choose a body finish of stainless steel or enamel.

Base dimension is 7 1/4 x 5 1/4 x 7 1/4" (18.4 x 13.3 x 18.4 cm), platforms measure 5 3/4 x 5 3/4" (14.6 x 14.6 cm) or 5 3/4 x 7 7/8" (14.6 x 20 cm) for 25 lb (55.1 kg) models.



74849

ITEM	CAPACITY		INCREMENT		BODY FINISH	DIAL TYPE	PACK
	LB	KG	OZ	G			
74840	1	.5	1/4	7.08	Enamel	Fixed	1
74843	2	.9	1/4	7.08	Enamel	Rotating	1
74846	5	2.3	1/2	14.17	Enamel	Rotating	1
74849	25	11.3	2	56.7	Enamel	Rotating	1
74852	*	500 g	-	2	Enamel	Rotating	1
74855	2	.9	1/4	7.08	S/S	Rotating	1

*Dial face reads in grams only



HEAVY-DUTY PORTION SCALES

Heavy-duty portion scales have an enamel finish, stainless steel platforms, an 8" (20.3 cm) dial face, shatterproof lens, and temperature compensated mechanisms. Platform is 9 x 9" (22.9 cm) with a base measuring 10 1/2 x 7 x 10 1/2" (26.7 x 17.8 x 26.7 cm).

ITEM	CAPACITY		INCREMENT		DIAL TYPE	PACK
	LB	KG	OZ	G		
53700*	2	4.4	1/8	3.5	Fixed	1
53701*	2	4.4	1/8	3.5	Rotating	1
53702	2	4.4	1/8	3.5	Fixed	1
53703	5	11	1/2	14.1	Fixed	1
53704	10	22	1	28.3	Fixed	1
53705	20	44	1	28.3	Fixed	1
53706	40	88.2	2	56.7	Fixed	1

*with Air Dash Pot



53702

HEAVY-DUTY PORTION/RECEIVING SCALE

Bigger loads require a larger surface area and wider base for balancing. The 60 or 100 lb capacity, heavy-duty portion scales have an enamel finish, a larger 10 1/2" (26.7 cm) dial face, shatterproof lens, and temperature compensated mechanism. Platform is 13 x 13" (33 x 33 cm) with a base measuring 14 3/4 x 10 x 14 1/4" (37.5 x 25.4 x 36.2 cm).



53708

ITEM	CAPACITY		INCREMENT		BODY FINISH	DIAL TYPE	PACK
	LB	KG	OZ	G			
53707	60	27.2	4	113.4	Enamel	Fixed	1
53708	100	45.3	4	113.4	Enamel	Fixed	1

HEAVY-DUTY PORTION/RECEIVING SCALE

Our largest capacity Alegacy scale. The extra large stainless steel platform and enamel finish base easily supports the 200 lb maximum. Features also include a large 10 1/2" (26.7 cm) dial face, shatterproof lens, and temperature control mechanisms. Platform is 15 1/2 x 15 1/2" (39.4 x 39.4 cm) with a base measuring 14 3/4 x 10 x 14 5/16" (37.5 x 25.4 x 36.4 cm).

ITEM	CAPACITY		INCREMENT		DIAL TYPE	PACK
	LB	KG	OZ	G		
53709	200	91	8	226.8	Fixed	1



BAKER'S DOUGH SCALE

Comes with a one-piece stainless steel scoop 12 1/2 x 18 1/2 x 4 7/8" (31.8 x 47 x 12.4 cm). The body is 14 x 5 1/2 x 7" (35.6 x 14 x 17.8 cm) of cold rolled steel with a white enamel finish. Stainless steel sliding pose, 1/4 oz increments.

ITEM	WEIGHTS	CAPACITY		PACK
		LB	KG	
53600	1 ea, 1, 2, 4 lb	8	17.6	1
53601	1 ea, 1, 2 lb 3 ea, 4 lb	16	35.3	1
CBDS1	Counter Weight			1
SBDS20	S/S Scoop Only			1

WEIGHTS

Counter weights or measuring weights for balance type scales. (53600 & 53601)

ITEM	CAPACITY		PACK
	LB	KG	
1W	1	.5	1
2WT	2	.9	1
4W	4	1.8	1

Alegacy Thermometers

Each is designed for specific applications with an eye for accuracy and dependability. Standard features include: 304 stainless steel frames or parts, accuracy of plus or minus 1° to 2°F, dual scale, and Fahrenheit and Celsius dials. Many are NSF listed, as indicated by the presence of the NSF logo.



P.O.P. Packaging

Clam shell packaging enhances presentation and sale of many thermometer products.

DIAL MEAT THERMOMETER

Thermometer has pointed stem with an accuracy +/- 1°. Dishwasher safe.

ITEM	LENGTH		DIAL DIAMETER		RANGE		PACK
	IN	CM	IN	CM	°F	°C	
MT84001	5	12.7	2 3/8	7	120 - 220	60 - 85	12

POCKET TEST THERMOMETER

304 stainless steel case, bezel and pointed stem. Accuracy of +/- 1°. Includes storage case with pocket clip. Individually boxed. Not for oven use.



ITEM	LENGTH		DIAL DIAMETER		RANGE	PACK
	IN	CM	IN	CM	°C	
PT84113	5	12.7	1	2.5	-10 - 110	1

POCKET TEST THERMOMETERS

304 stainless steel case, bezel and pointed stem. Available in a variety of temperature ranges. Accuracy of +/- 1°. Includes storage case with pocket clip. Individually boxed. NSF listed. Not for oven use.



ITEM	LENGTH		DIAL DIAMETER		RANGE	PACK
	IN	CM	IN	CM	°F	
PT84104	5	12.7	1	2.5	50 - 550	1
PT84107	5	12.7	1	2.5	25 - 125	1
PT84101	5	12.7	1	2.5	0 - 220	1
PT84110	5	12.7	1	2.5	-40 - 160	1



DIGITAL THERMOMETER

Push buttons control digital readout providing accurate temperature readings.

ITEM	PROBE STYLE	LENGTH		RANGE		PACK
		IN	CM	°F	°C	
DT84116	Thin	6	15.2	-40 - 450	-40 - 230	12
DT84117	Thick	6	15.2	-40 - 450	-40 - 230	12

OVEN THERMOMETER

Hangs with top clip, or stands with an extra wide base.

Made of 304 stainless steel, with an accuracy of +/- 1°. NSF listed.

ITEM	HEIGHT		DIAL DIAMETER		RANGE		PACK
	IN	CM	IN	CM	°F	°C	
OT84010	3 3/4	9.5	2 3/8	6	150 - 550	70 - 280	12



OVEN THERMOMETER

Dual scale (°F or °C), thermometer hangs or stands.

Made of 304 stainless steel, with an accuracy of +/- 1°.

ITEM	HEIGHT		DIAL DIAMETER		RANGE		PACK
	IN	CM	IN	CM	°F	°C	
OT84013	3	7.6	2 3/8	6	200 - 500	100 - 250	12



REFRIGERATOR & FREEZER THERMOMETER

Made of 304 stainless steel, thermometer hangs or stands and has a dual scale (°F and °C) with an accuracy of +/- 2°F.

ITEM	HEIGHT		DIAL DIAMETER		RANGE		PACK
	IN	CM	IN	CM	°F	°C	
RT84016	3 3/4	9.5	2 3/8	6	-20 - 80	-30 - 30	12
RT84019	2 3/4	7	2 3/8	6	-30 - 70	-35 - 20	12



RT84016



RT84019



CT84031



CT84004

CANDY/JELLY/DEEP FRY THERMOMETER

Glass thermometer of 304 stainless steel with a heat-resistant handle and an adjustable container clip. Dual scale (°F and °C) with an accuracy of +/- 1°. Dishwasher safe.

ITEM	LENGTH		DIAL DIAMETER		RANGE		PACK
	IN	CM	IN	CM	°F	°C	
CT84031	12	30.5	1 7/8	4.7	100 - 400	40 - 200	12
CT84004	6 1/4	15.8	2 1/4	5.7	100 - 400	40 - 200	12



REFRIGERATOR/FREEZER THERMOMETER

Rustproof, made of 304 stainless steel, and with a dual scale, thermometer hangs or stands. It is NSF listed.

ITEM	WIDTH		HEIGHT		RANGE		PACK
	IN	CM	IN	CM	°F	°C	
FT84028	4 7/8	12.4	1 1/4	3.2	-40 - 80	-40 - 27	12

CANDY/FRY THERMOMETER

Includes adjustable pan clip and quick reference guide on thermometer face.



CT84122

CT84119

ITEM	LENGTH		DIAL DIAMETER		RANGE		PACK
	IN	CM	IN	CM	°F	°C	
CT84119	8	20.3	2 1/8	5.4	50 - 550	50 - 250	12
CT84122	12	30.5	2 1/8	5.4	50 - 550	50 - 250	12



Allergen-Free ColorCode System

Alegacy offers a variety of items, color coded in purple, to identify use in allergen-free food preparation and cooking.



COOK'S KNIFE



ITEM	BLADE LENGTH		PACK
	IN	CM	
 PC12910PLCH	10	25.4	6



STAINLESS STEEL TONG

	LENGTH		
	IN	CM	PACK
5511PL	9 ½	24.1	12
5512PL	12	30.5	12
5513PL	16	40.6	12



FOOD PORTIONER

One piece food portioners with purple color handle, designated for the preparation of allergen-free foods.

	DESCRIPTION	HANDLE COLOR	CAPACITY		LENGTH		PACK
			OZ	ML	IN	CM	
6722	Solid	Purple	2	59	13	33	12
6722P	Perforated	Purple	2	59	13	33	12
6723	Solid	Purple	3	88	13	33	12
6723P	Perforated	Purple	3	88	13 ¼	33.7	12
6724	Solid	Purple	4	118	13 ¾	34.9	12
6724P	Perforated	Purple	4	118	13 ¾	34.9	12
6726	Solid	Purple	6	176	14 ¼	36.2	12
6726P	Perforated	Purple	6	176	14 ¼	36.2	12
6728	Solid	Purple	8	238	14 ¾	37.5	12
6728P	Perforated	Purple	8	238	14 ¾	37.5	12



Economy line offerings are identified by our green e-line icon and matching color-coded chart items.

ALLERGEN-FREE COLORCODE SYSTEM BOARDS

Purple color, in a medium density, is designated for the preparation of allergen-free foods.

ITEM	COLOR	IN	CM	PACK
 PER1218MP	Purple	12 x 18 x 1/2	30.1 x 45.7 x 1.3	6
PER1520MP	Purple	15 x 20 x 1/2	38.1 x 50.8 x 1.3	6
PER1824MP	Purple	18 x 24 x 1/2	45.7 x 61 x 1.3	3

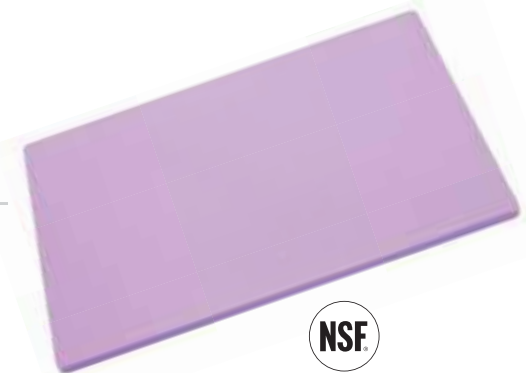



PIZZA SUPPLIES

Pizza Trays & Screens
180 - 181

Pizza Cutters
181

Pizza Peels
182

Pizza Stand
182

Pizza Pouch
183

Accessories
183

Cheese Shakers
184 - 185

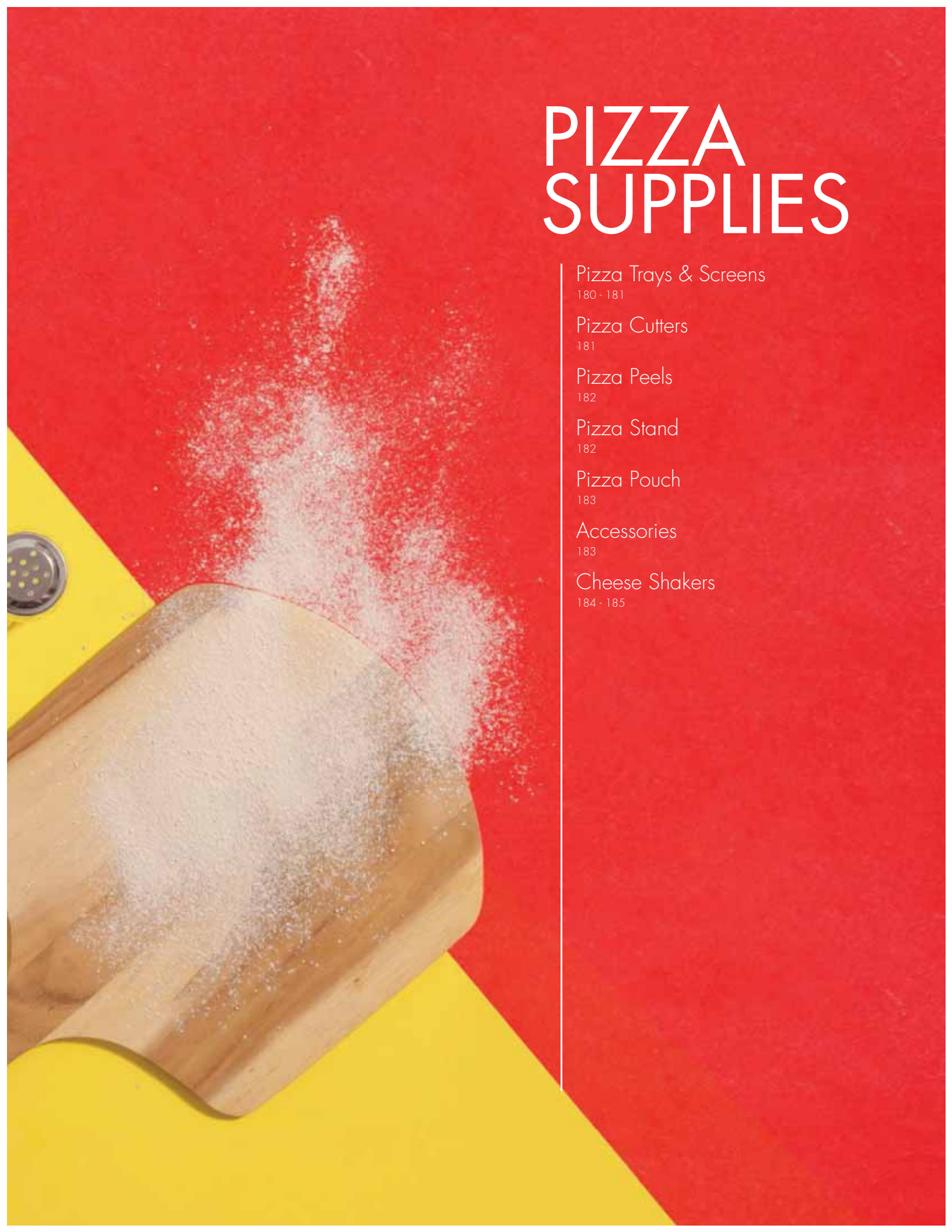

Professional Aluminum Pizza Trays & Screens

Pizza trays get thrown around, dropped, abused, and scrubbed and still need to be strong enough to use again and again, in addition to maintaining a presentable appearance. Our high quality, dependable, thick, aluminum alloy pizza pans and screens come in a variety of sizes. Choose from our own Eagleware® pizza pans, made in the U.S.A., or our quality imported pizza screens. They're both a great choice for any level of operation.



Eagleware Professional Aluminum Pizza Trays

"A" and "HA" series are standard rim trays. "SA" and "HSA" series are continental "coupe" rim trays. "FHA" are heavy-duty flat rim trays. All pans are made of .032" (.8 mm) and .040" (1 mm) (heavyweight) thick 3004 aluminum alloy. The edges are rolled for no hard-to-clean openings.

.032" THICKNESS (.8 MM)

ITEM	DIAMETER		PACK
	IN	CM	
A8	8	20.3	12
A9	9	22.9	12
A10	10	25.4	12
A11	11	27.9	12
A12	12	30.5	12
A13	13	33	12
A14	14	35.6	12
A15	15	38.1	12
A16	16	40.6	12
A17	17	43.2	12

.040" THICKNESS (1 MM)

ITEM	DIAMETER		PACK
	IN	CM	
HA7	7	17.8	12
HA8	8	20.3	12
HA9	9	22.9	12
HA10	10	25.4	12
HA11	11	27.9	12
HA12	12	30.5	12
HA13	13	33	12
HA14	14	35.6	12
HA15	15	38.1	12
HA16	16	40.6	12
HA17	17	43.2	12

.040" THICKNESS (1 MM)

ITEM	DIAMETER		PACK
	IN	CM	
FHA8	8	20.3	12
FHA9	9	22.9	12
FHA10	10	25.4	12
FHA11	11	27.9	12
FHA12	12	30.5	12
FHA13	13	33	12
FHA14	14	35.6	12
FHA15	15	38.1	12
FHA16	16	40.6	12
FHA17	17	43.2	12

.032" THICKNESS (.8 MM)

ITEM	DIAMETER		PACK
	IN	CM	
SA11	11	27.9	12
SA13	13	33	12
SA15	15	38.1	12
SA17	17	43.2	12

.040" THICKNESS (1 MM)

ITEM	DIAMETER		PACK
	IN	CM	
HSA11	11	27.9	12
HSA13	13	33	12
HSA15	15	38.1	12
HSA17	17	43.2	12

* Please see Professional Cookware page 17 for rim diagrams.



SEAMLESS RIM ALUMINUM PIZZA SCREEN

Produce an evenly baked pizza with our seamless rim screens of expanded mesh that allows air to circulate beneath the crust.



ITEM	DIAMETER		PACK
	IN	CM	
SPS7	7	17.8	12
SPS8	8	20.3	12
SPS9	9	22.9	12
SPS10	10	25.4	12
SPS11	11	27.9	12
SPS12	12	30.5	12
SPS13	13	33	12
SPS14	14	35.6	12
SPS15	15	38.1	12
SPS16	16	40.6	12
SPS17	17	43.2	12
SPS18	18	45.7	12



PIZZA CUTTER - POLYPROPYLENE HANDLE

The sanitary stainless steel cutting wheel has an easy grip ABS plastic handle for the best cut with the least effort.

ITEM	WHEEL DIAMETER		LENGTH		PACK
	IN	CM	IN	CM	
PC2001	2 1/2	6.4	7	17.8	12
PC996	4	10.2	9 1/4	23.5	12



PIZZA CUTTER - ALUMINUM HANDLE

Heavy cast aluminum handle and stainless steel wheel ensure extra durability and sharp even cuts.

ITEM	WHEEL DIAMETER		LENGTH		PACK
	IN	CM	IN	CM	
2003	2 1/2	6.4	6 1/4	15.9	12
2005	3 3/4	9.5	8	20.3	12



PIZZA CUTTER - LONG WOODEN HANDLE

Extra-long cutter has a stainless steel wheel and a hardwood lacquered handle.

ITEM	WHEEL DIAMETER		LENGTH		PACK
	IN	CM	IN	CM	
996LH	4	10.2	22 1/2	57.2	1

ALUMINUM PIZZA SCREEN

Aluminum pizza screens produce an evenly baked crust by allowing air to circulate beneath the crust while baking.

ITEM	DIAMETER		PACK
	IN	CM	
PS8	8	20.3	12
PS9	9	22.9	12
PS10	10	25.4	12
PS11	11	27.9	12
PS12	12	30.5	12
PS13	13	33	12
PS14	14	35.6	12
PS15	15	38.1	12
PS16	16	40.6	12
PS17	17	43.2	12
PS18	18	45.7	12

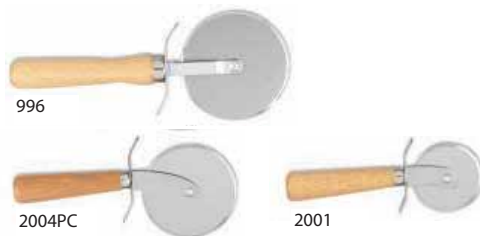

PIZZA CUTTER - WOODEN HANDLE

Pizza cutter has a stainless steel wheel, rust proof guards, and a hardwood lacquered handle.

ITEM	WHEEL DIAMETER		LENGTH		PACK
	IN	CM	IN	CM	
2001	2 1/2	6.4	7 1/2	19.1	12
2004PC	3 1/2	8.9	8	20.3	12
996	4	10.2	10	25.4	12

ALUMINUM BLADE PIZZA PEELS

Made of heavy gauge aluminum with a triple riveted hardwood handle.



ITEM	BLADE SIZE		O/A LENGTH		PACK
	IN	CM	IN	CM	
23501	12 x 12	30.5 x 30.5	26 1/2	67.3	12
23506	12 x 12	30.5 x 30.5	35 1/2	90.2	12
23511	12 x 12	30.5 x 30.5	51 1/2	130.8	12
23516	16 x 18	40.6 x 45.7	39 1/2	100.3	12



PAN GRIPPER

Self locking gripper is nickel-plated steel. Ideal for grasping deep dish pans.

ITEM	DESCRIPTION	LENGTH		
		IN	CM	PACK
PG1	60° Angle	7 1/2	19.1	12



WOODEN PIZZA PEELS

Made of seasoned lumber, the blade tapers at the tip and on both sides.

ITEM	BLADE WIDTH		BLADE LENGTH		O/A LENGTH		PACK
	IN	CM	IN	CM	IN	CM	
5116	12	30.5	14	35.6	22	55.9	12
5117	14	35.6	17	43.2	24	60.9	12
5216	12	30.5	14	35.6	36	91.4	12
5217	14	35.6	16	40.6	36	91.4	12
5316	16	40.6	18	45.7	36	91.4	12
5318	18	45.7	19	48.3	36	91.4	12
531642	16	40.6	18	45.7	42	106.7	12
531842	18	45.7	19	48.3	42	106.7	12

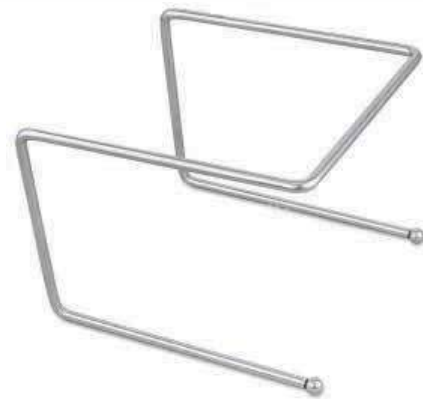

PIZZA STAND

Stand is made of chrome-plated 5/16" (.8 cm) wire rod. Stand adds room under pizza trays for salt and pepper shakers, cheese shakers, etc.

ITEM	IN	CM	PACK
PS180	6 3/4 x 8 1/2 x 9	17.1 x 21.6 x 22.9	1



STAINLESS STEEL MIXING PADDLE

Easy-to-clean, one-piece stainless steel mixing paddle for mixing sauce.

ITEM	O/A LENGTH		BLADE		PACK
	IN	CM	IN	CM	
19924	24	60.9	4 1/2 x 8	11.4 x 20.3	1
19930	30	76.2	4 1/2 x 8	11.4 x 20.3	1
19936	36	91.4	4 1/2 x 8	11.4 x 20.3	1
19942	42	106.7	4 1/2 x 8	11.4 x 20.3	1
19948	48	121.9	4 1/2 x 8	11.4 x 20.3	1
19954	54	137.2	4 1/2 x 8	11.4 x 20.3	1
19960	60	152.4	4 1/2 x 8	11.4 x 20.3	1



FLAT BOTTOM PIZZA LADLE

For applying pizza sauce to crusts. Flat bottom aids in spreading pizza sauce evenly.

ITEM	CAPACITY		HANDLE		
	OZ	ML	IN	CM	PACK
86113	5	147.9	15	38.1	12
61116	6	177.4	15	38.1	12

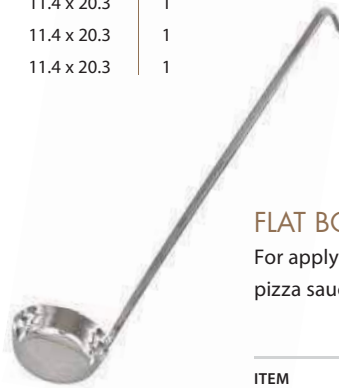

ROLLER DOCKER

Docker has a 5" (12.7 cm) nylon roller and a cast aluminum handle.

ITEM	O/A LENGTH		
	IN	CM	PACK
RD582	8	20.3	1



DOUGH SCRAPER

Stainless steel blade with nickel-plated rivets. Excellent for dividing dough and scraping dough from flat surfaces.

ITEM	DESCRIPTION	IN	CM	PACK
182DS	Hardwood	4 x 6	10.2 x 15.2	12
182PH	Plastic	4 x 6	10.2 x 15.2	12
183	Hardwood	5 x 7	12.7 x 17.8	12



INSULATED PIZZA POUCH

Ideal for transporting and keeping pizzas warm. The pouch is heavily insulated and has velcro closures.

ITEM	IN	CM	PACK
PP1	17 x 17 x 5	43.2 x 43.2 x 12.7	6



800CS



800CSP

CHEESE SHAKER

Clear fluted shaker with a stainless steel perforated top. Available in glass or plastic.

ITEM	DESCRIPTION	CAPACITY		HEIGHT		DIAMETER		PACK
		OZ	ML	IN	CM	IN	CM	
800CS	Glass Jar	12	355	5 5/8	14.3	3	7.6	24
800CSP	Plastic Jar	12	355	5 5/8	14.3	3	7.6	24



801X

CHEESE SHAKER

Clear glass shaker with a stainless steel or gold perforated top.

ITEM	DESCRIPTION	CAPACITY		HEIGHT		DIAMETER		PACK
		OZ	ML	IN	CM	IN	CM	
801X	S/S Top	6	177.5	3 5/8	9.2	2 5/8	6.7	12
801XG	Gold Top	6	177.5	3 5/8	9.2	2 5/8	6.7	12



802X

CHEESE SHAKER

Clear glass shaker with a stainless steel or gold perforated top.

Also available in a plastic shaker (802XPL).

ITEM	CAPACITY		HEIGHT		DIAMETER		PACK
	OZ	ML	IN	CM	IN	CM	
802X	6	177.5	3 5/8	9.2	2 5/8	6.7	36
802DZ	6	177.5	3 5/8	9.2	2 5/8	6.7	12
802XPL	6	177.5	3 5/8	9.2	2 5/8	6.7	24



802XG

CHEESE SHAKER

Gold top adds attractive styling for elegant service.

ITEM	CAPACITY		HEIGHT		DIAMETER		PACK
	OZ	ML	IN	CM	IN	CM	
802XG	6	177.5	3 5/8	9.2	2 5/8	6.7	36
802XGDZ	6	177.5	3 5/8	9.2	2 5/8	6.7	12

CHEESE SHAKER

Swirl glass shaker with a stainless steel slotted top. Also available in a plastic shaker (803XPL).

ITEM	CAPACITY		HEIGHT		DIAMETER		PACK
	OZ	ML	IN	CM	IN	CM	
803X	6	177.5	3 5/8	9.2	2 5/8	6.7	36
803DZ	6	177.5	3 5/8	9.2	2 5/8	6.7	12
803XPL	6	177.5	3 5/8	9.2	2 5/8	6.7	24



803X



SD4571

AL257

SD2571

SDH2571

AL257WO

PD2571

DREDGES

Stainless steel, aluminum, and plastic dredges have universal holes and are perfect for dispensing cheese and spices.

ITEM	DESCRIPTION	CAPACITY				PACK
		OZ	ML	IN	CM	
STAINLESS STEEL						
SD2571	Without Handle	12	354.8	2 7/8 x 3 3/4	7.3 x 9.5	12
SDH2571	With Handle	12	354.8	2 7/8 x 3 1/2	7.3 x 8.9	12
SD3571	Without Handle	16	473.1	2 7/8 x 5 1/4	7.3 x 13.3	12
SDH3571	With Handle	16	473.1	2 7/8 x 5 1/4	7.3 x 13.3	12
SD4571	Without Handle	22	650.5	2 7/8 x 7 1/8	7.3 x 18.1	6
ALUMINUM						
AL257	With Handle	10	295.7	2 3/4 x 3 5/8	7 x 9.2	12
AL257WO	Without Handle	10	295.7	2 5/8 x 3 1/2	6.7 x 8.9	12
ADH3571	With Handle	13	384.4	2 3/4 x 4	7 x 10.2	12
AD3571	Without Handle	13	384.4	2 3/4 x 4	7 x 10.2	12
PLASTIC						
PD2571	With Handle	10	295.7	2 3/4 x 3 5/8	7 x 9.2	12

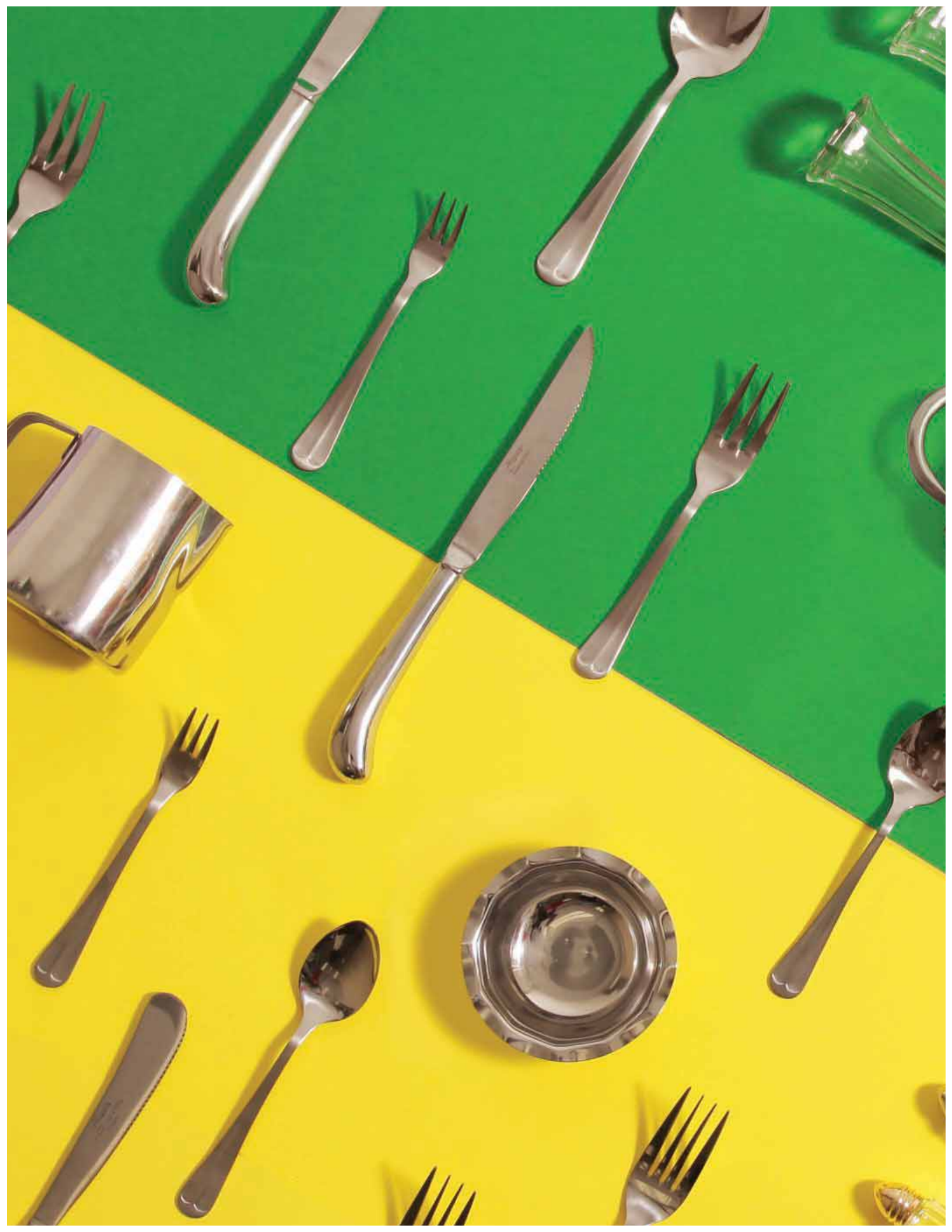



TABLETOP & SERVICE

Shakers & Pourers

188 - 192

Oil & Vinegar Racks

193 - 195

Table Accessories

196 - 201

Baskets

202 - 203

Flatware

204 - 207

Serving Pitchers & Holloware

209 - 215

Serving Platters

216 - 218

Counter Dispensers & Pumps

219 - 222

Toothpick Dispensers

223

Tray Stands & High Chairs

224 - 225

Salt & Pepper Shakers

Customers take salt and pepper shakers for granted, but not us. We've assembled enough varieties of shakers to make every table impressive. Elegant or economical, Alegacy gives your client the edge on presentation.



SALT & PEPPER SHAKERS

Paneled glass jars with universal hole tops that are mushroom shaped stainless steel.

ITEM	CAPACITY		DIMENSIONS (H x W)		PACK
	OZ	ML	IN	CM	
150SP	1	29	3 x 1 5/8	7.6 x 4.1	72
151SP	2	59	3 5/8 x 2	9.2 x 5.1	72
156SP	3	88	4 5/8 x 2 1/8	11.7 x 5.4	72



SALT & PEPPER SHAKER

Square glass salt and pepper shaker with stainless steel top.

ITEM	CAPACITY		DIMENSIONS (H x W)		PACK
	OZ	ML	IN	CM	
154SP	2	59.1	4 x 1 1/2	10.1 x 3.8	24



SALT & PEPPER SHAKERS

Paneled glass jars with flat shaped universal hole, stainless steel tops.

ITEM	CAPACITY		DIMENSIONS (H x W)		PACK
	OZ	ML	IN	CM	
152SP	1	29	3 x 1 1/2	7.6 x 3.8	72
153SP	2	59	3 3/4 x 2	9.5 x 5.1	72



BARREL SALT & PEPPER SHAKERS

Tall, tapered shaker with stainless steel top.

ITEM	CAPACITY		DIMENSIONS (H x W)		
	OZ	ML	IN	CM	PACK
157SP	3	88	4 5/8 x 1 7/8	11.7 x 4.8	72



MINI SALT & PEPPER SHAKERS

Square glass salt and pepper shaker with bullet top.

ITEM	CAPACITY		DIMENSIONS (H x W)		
	OZ	ML	IN	CM	PACK
155SP	1/2	14.8	2 x 1 1/2	5.1 x 3.8	432



SALT & PEPPER SHAKERS

Paneled glass jar, aluminum top with universal holes.

ITEM	CAPACITY		DIMENSIONS (H x W)		
	OZ	ML	IN	CM	PACK
30SP	1 5/8	48	3 x 1 1/4	7.6 x 3.2	36



BULLET SALT & PEPPER SHAKERS

Paneled glass jar, chrome-plated plastic top with universal holes.

ITEM	CAPACITY		DIMENSIONS (H x W)		
	OZ	ML	IN	CM	PACK
77SP	1	29	3 1/8 x 2	7.9 x 5.1	72



TOWER SALT & PEPPER SHAKERS

Sleek, modern style glass, chrome-plated or gold top with universal holes.

ITEM	TOP	CAPACITY		DIMENSIONS (H x W)		
		OZ	ML	IN	CM	PACK
158S	Chrome-Plated	1 1/2	44	4 1/2 x 2	11.4 x 5.1	24
158GD	Gold-Plated	1 1/2	44	4 1/2 x 2	11.4 x 5.1	24

Pourers & Cheese Shakers

Go from sugar to spicy hot pepper flakes with Alegacy's shakers and pourers. Or, sprinkle a little extra flavor with a classic collection of cheese shakers. Attractive, practical, and easy to clean and refill. Something no restaurant should be without.



57S

SUGAR POURER

Fluted glass sugar pourer has a stainless steel top and a self-closing side spout.

ITEM	CAPACITY		HEIGHT		DIAMETER		PACK
	OZ	ML	IN	CM	IN	CM	
57S	12	355	5 5/8	14.3	3	7.6	24

SUGAR POURER

A fluted glass sugar pourer with a center hole stainless steel top.

ITEM	CAPACITY		HEIGHT		DIAMETER		PACK
	OZ	ML	IN	CM	IN	CM	
55S	12	355	5 5/8	14.3	3	7.6	24



55S



57SP

PLASTIC SUGAR POURERS

Clear fluted plastic shaker with stainless steel top and self-closing side or center spout.

ITEM	CAPACITY		HEIGHT		DIAMETER		PACK
	OZ	ML	IN	CM	IN	CM	
55SP	12	355	5 5/8	14.3	3	7.6	24
57SP	12	355	5 5/8	14.3	3	7.6	24

CHEESE SHAKER

Clear fluted glass shaker with a stainless steel perforated top.

ITEM	CAPACITY		HEIGHT		DIAMETER		PACK
	OZ	ML	IN	CM	IN	CM	
800CS	12	355	5 5/8	14.3	3	7.6	24



800CS

PLASTIC CHEESE SHAKER

Clear fluted plastic shaker with a stainless steel perforated top.

ITEM	CAPACITY		HEIGHT		DIAMETER		PACK
	OZ	ML	IN	CM	IN	CM	
800CSP	12	355	5 5/8	14.3	3	7.6	24



800CSP



801X

CHEESE SHAKER

Clear glass shaker with stainless steel or gold perforated top.

ITEM	TOP	CAPACITY		HEIGHT		DIAMETER		PACK
		OZ	ML	IN	CM	IN	CM	
801X	S/S Top	6	177.5	3 5/8	9.2	2 5/8	6.7	12
801XG	Gold Top	6	177.5	3 5/8	9.2	2 5/8	6.7	12



802X

CHEESE SHAKER

Swirl glass shaker with stainless steel perforated top. Also available in a plastic shaker (802XPL).

ITEM	CAPACITY		HEIGHT		DIAMETER		PACK
	OZ	ML	IN	CM	IN	CM	
802X	6	177.5	3 5/8	9.2	2 5/8	6.7	36
802DZ	6	177.5	3 5/8	9.2	2 5/8	6.7	12
802XPL	6	177.5	3 5/8	9.2	2 5/8	6.7	24



802XG

CHEESE SHAKER

Gold top adds attractive styling for elegant service.

ITEM	CAPACITY		HEIGHT		DIAMETER		PACK
	OZ	ML	IN	CM	IN	CM	
802XG	6	177.5	3 5/8	9.2	2 5/8	6.7	36
802XGDZ	6	177.5	3 5/8	9.2	2 5/8	6.7	12



803X

CHEESE SHAKER

Swirl glass shaker with stainless steel slotted top. Also available in a plastic shaker (803XPL).

ITEM	CAPACITY		HEIGHT		DIAMETER		PACK
	OZ	ML	IN	CM	IN	CM	
803X	6	177.5	3 5/8	9.2	2 5/8	6.7	36
803DZ	6	177.5	3 5/8	9.2	2 5/8	6.7	12
803XPL	6	177.5	3 5/8	9.2	2 5/8	6.7	24

Cash & Carry Collection

Our selection of shakers, cruets, and dispensers are now attractively designed and packaged to increase point of sale purchasing.

SALT & PEPPER SHAKERS

ITEM	CAPACITY		PACK	
	OZ	ML	INNER	MASTER
AL6150SP	1	29	6 ea	12 pk
AL6151SP	2	59	6 ea	12 pk
AL6156SP	3	88	6 ea	12 pk



CHEESE SHAKERS

ITEM	CAPACITY		PACK	
	OZ	ML	INNER	MASTER
AL2802X	6	177.5	2 ea	12 pk
AL2800CS	12	355	2 ea	12 pk

TOWER SALT & PEPPER SHAKERS

ITEM	CAPACITY		PACK	
	OZ	ML	INNER	MASTER
AL6158S	1 1/2	44	6 ea	6 pk



MINI CUBE SALT & PEPPER SHAKERS

ITEM	CAPACITY		PACK	
	OZ	ML	INNER	MASTER
AL6155SP	1/2	14.8	6 ea	12 pk

OIL & VINEGAR CRUETS

ITEM	CAPACITY		PACK	
	OZ	ML	INNER	MASTER
AL2600S	6	177.5	2 ea	12 pk

MUSHROOM TOP SALT & PEPPER SHAKERS

ITEM	CAPACITY		PACK	
	OZ	ML	INNER	MASTER
AL6154SP	2	59.1	6 ea	12 pk

SYRUP DISPENSERS

ITEM	CAPACITY		PACK	
	OZ	ML	INNER	MASTER
AL22212FL	12	355	2 ea	6 pk

SUGAR POURER

ITEM	CAPACITY		PACK	
	OZ	ML	INNER	MASTER
AL257S	12	355	2 ea	12 pk



All items shrink-wrapped. All items sold by pack in master case quantity only.



120PM

PEPPER MILL

Made in Italy with a forged steel mechanism, walnut finish, and brass ferrule.

ITEM	HEIGHT		PACK
	IN	CM	
120PM	12 1/2	31.8	1



OIL & VINEGAR DISPENSER

Square glass bottle with stainless steel pouring top.

ITEM	DESCRIPTION	CAPACITY				PACK
		OZ	ML	IN	CM	
600S	Bottle w/ S/S Top	4	118.2	6 x 2	15.2 x 5.1	36
600G	Bottle Only	4	118.2	5 1/4 x 2	13.3 x 5.1	36
600R	Rack	-	-	9 x 2 1/4	22.9 x 5.7	6
600PT	Plastic Top	-	-	-	-	12
600ST	S/S Top	-	-	-	-	12

 Economy line offerings are identified by our green e-line icon and matching color-coded chart items.



FLUTED MELAMINE RAMEKIN

ITEM	COLOR	CAPACITY		HEIGHT		PACK
		OZ	ML	IN	CM	
 RFM3BLK	Black	3	88.7	3 3/16 x 1 5/8	8.1 x 4.1	24
RFM3BL	Blue	3	88.7	3 3/16 x 1 5/8	8.1 x 4.1	24
RFM3BO	Bone	3	88.7	3 3/16 x 1 5/8	8.1 x 4.1	24
RFM3RD	Red	3	88.7	3 3/16 x 1 5/8	8.1 x 4.1	24
RFM3WH	White	3	88.7	3 3/16 x 1 5/8	8.1 x 4.1	24
RFM3YL	Yellow	3	88.7	3 3/16 x 1 5/8	8.1 x 4.1	24



STATIONARY SERVER

Three stainless steel bowls with chrome-plated wire carrier and large loop carrying handle.

ITEM	DESCRIPTION	CAPACITY		IN	CM	PACK
		OZ	ML			
1140	Complete Set	24	708	10 x 8 ⁵ / ₈	25.4 x 21.9	1
1140B	Bowl Only	24	708	5 ³ / ₁₆ x 3	13.2 x 7.6	12
1140R	Rack Only	-	-	9 ¹ / ₂ x 8 ⁵ / ₈	24.1 x 21.9	1



CONDIMENT JAR

Glass jars and covers complement complete service with chrome-plated wire, top-loop carrying handle. 6 oz (177.4 ml). Plastic version, PCMJ6G is 7 oz (207 ml).

ITEM	DESCRIPTION	DIMENSIONS (D x H)		PACK
		IN	CM	
MJ6GR	2 Units w/ Rack	6 ¹ / ₂ x 7 ¹ / ₄	16.5 x 18.4	6
MJ6R	Two Ring Rack	7 ¹ / ₂ x 7 ¹ / ₄	19.1 x 18.4	6
MJ6TP	Plastic Top	3 x 1	7.6 x 2.5	12
MJ6J	Glass Only	3 x 3	7.6 x 7.6	12
MJ6TS	S/S Tops Only	3 x 1 ¹ / ₂	7.6 x 1.3	12
PCMJ6G	Plastic Jar Only	3 X 2 ³ / ₄	7.6 X 7	12



PCMJ6G



OIL & VINEGAR RACK

Chrome-plated, with wire top-loop carrying handle.

ITEM	DESCRIPTION	DIMENSIONS (H x W)		PACK
		IN	CM	
193R	2 Ring Rack	7 ¹ / ₄ x 8	18.4 x 20.3	12



REVOLVING RELISH SERVER

Set includes a plastic stand, three 8 oz (236 ml) plastic bowls with lids, and three stainless steel spoons.

ITEM	DIMENSIONS (W x H)		PACK
	IN	CM	
RS8053P	7 ¹ / ₂ x 8	19.1 x 20.3	1

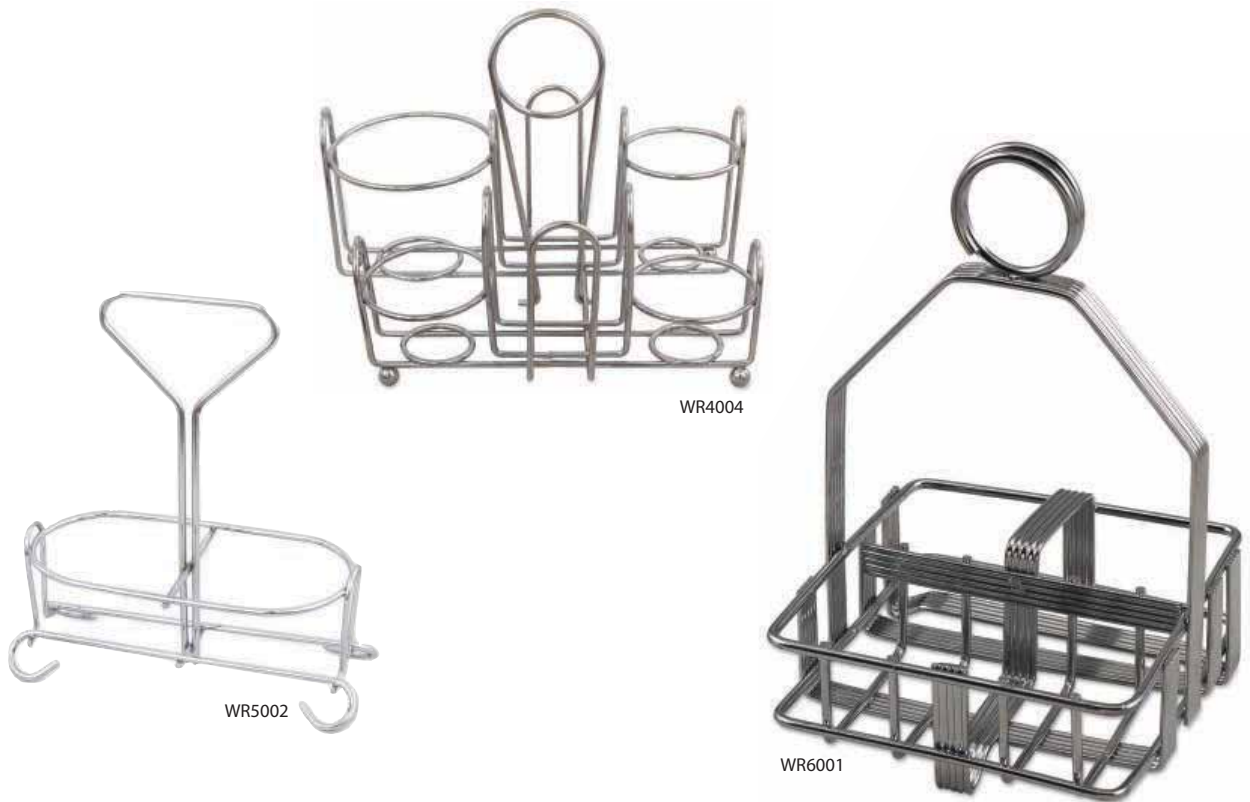

WIRE RACKS

Chrome-plated wire racks serve a variety of uses.

ITEM	DESCRIPTION*	DIMENSIONS (H x L x W)		
		IN	CM	PACK
WR4004	S&P Shakers, Condiment Bottles & Sugar/Creamer Packets	6 x 8 7/8 x 6	15.2 x 22.5 x 15.2	12
WR5002	Holds Two #2212FL Servers	7 3/4 x 7 1/2 x 3 3/8	19.7 x 19.1 x 8.6	12
WR6001	Holds up to Four S&P Shakers	7 5/8 x 6 3/4 x 3	19.6 x 17.1 x 7.6	12
WR6002	Holds Two #2206FL Servers	8 x 7 1/8 x 3 1/2	20.3 x 18.1 x 8.9	12
WR7002	Holds Two #2214FL Servers	8 1/8 x 8 1/2 x 4	20.6 x 21.6 x 10.2	12
WR7003	Holds Three Condiment Jars	7 1/4 x 7 x 7	18.4 x 17.8 x 17.8	12

*All item numbers refer to racks only



Syrup Dispensers

These attractive, durable, and easy-to-clean dispensers have dozens of uses. Fill them with syrup, honey, cream, salad dressing, juice, and milk. Each dispenser has a heavy glass container and is available with a chrome-plated top and handle with stainless steel slide and rubber gasket. They are also available with an all plastic top.



SYRUP DISPENSER

Dispenser is a teardrop shaped glass container with one-piece, heavy-duty, chrome-plated flat metal top and handle with a stainless steel slide. Also available with a plastic top as listed below.

ITEM	CAPACITY		HEIGHT		DIAMETER		PACK
	OZ	ML	IN	CM	IN	CM	
FLAT METAL TOP							
2206FL	6	236.5	4	10.1	2	5.1	12
2212FL	12	354.8	5 1/2	13.9	3 3/8	8.6	12
2214FL	14	414	6	15.2	3 1/2	8.9	12
PLASTIC TOP							
2206PL	6	236.5	4	10.1	2 3/4	7	12
2212PL	12	354.8	5 1/2	13.9	3 3/8	8.6	12



WIRE SUGAR PACK HOLDER

Sugar pack holder made of chrome-plated wire with four ball feet, has two compartments for packaged sugar, and handle can be used as a card holder.

ITEM	DIMENSIONS (H x L x W)			PACK
	IN	CM	PACK	
177	5 1/4 x 5 x 3	13.3 x 12.7 x 7.6	12	

WIRE SUGAR PACK HOLDER

Sugar pack holder made of chrome-plated wire with four ball feet, has two compartments for packaged sugar, and two outside rings for salt and pepper shakers, up to 1 3/4" (4.4 cm) diameter. Handle can be used as cardholder.

ITEM	DIMENSIONS (H x L x W)			PACK
	IN	CM	PACK	
188	7 1/2 x 5 x 4 1/2	19 x 12.7 x 11.4	12	



SYRUP PITCHER

ITEM	CAPACITY		DIMENSIONS		
	OZ	ML	IN	CM	PACK
 SYR2	2 1/2	74	2 1/4 x 2	5.7 x 5.1	24



SPH322BR

SUGAR PACK HOLDER

ITEM	COLOR	IN	CM	PACK
 SPH322BLK	Black	2 X 3 3/8 X 2 1/2	5.1 X 8.6 X 6.4	24
SPH322CLR	Clear	2 X 3 3/8 X 2 1/2	5.1 X 8.6 X 6.4	24
SPH322WH	White	2 X 3 3/8 X 2 1/2	5.1 X 8.6 X 6.4	24
SPH322BR	Brown	2 X 3 3/8 X 2 1/2	5.1 X 8.6 X 6.4	24

 Economy line offerings are identified by our green e-line icon and matching color-coded chart items.



WINE BUCKET

Present wine and champagne to your patrons' tables in this attractive and practical wine bucket.

ITEM	DESCRIPTION	HEIGHT		DIAMETER		PACK
		IN	CM	IN	CM	
6950	Bucket and Stand	32	81.2	-	-	1
69501	18/8 S/S Bucket	9 1/2	24.1	8 3/4	22.2	6
69502	Stand Only	29 1/2	74.9	-	-	1



WINE BUCKET

A wide selection of wine buckets, from plain and hammered patterns to mirror finishes with elegant details, complement any dining occasion.



ITEM	DESCRIPTION	HEIGHT		DIAMETER		PACK
		IN	CM	IN	CM	
79501	Hammered Wine Bucket	8 1/2	21.6	7 1/2	19.1	1
79502	Wine Bucket Stand	24	61	-	-	1
89501	Wine Bucket	8 3/8	21.3	8 3/8	21.3	1
IB22	Ice Bucket	5 7/8	14.9	6 5/16	16	1





NAPKIN DISPENSERS

For standard 3 1/2 x 7" (8.9 x 17.8 cm) or junior 3 1/2 x 4 1/4" (8.9 x 10.8 cm) napkins, with a capacity of 150 napkins.

ITEM	DESCRIPTION	IN	CM	NAPKIN SIZE	PACK
221	Chrome-Plated	4 x 4 1/2 x 7 1/2	10.2 x 11.4 x 19.1	Standard	1
221S	Stainless Steel	4 x 4 1/2 x 7 1/2	10.2 x 11.4 x 19.1	Standard	1
231	Chrome-Plated	4 x 4 1/2 x 5 3/4	10.2 x 11.4 x 14.6	Junior	1
231S	Stainless Steel	4 x 4 1/2 x 5 3/4	10.2 x 11.4 x 14.6	Junior	1



3012



306

SNAIL (ESCARGOT) PLATE

Stainless steel with a mirror finish.

ITEM	CAPACITY	DIAMETER		PACK
		IN	CM	
306	6 Hole	5 3/8	13.7	12
3012	12 Hole	7 1/4	18.4	12



SNAIL HOLDER

Stainless steel holder allows for easy gripping of snails. Mirrored finish.

ITEM	LENGTH		
	IN	CM	PACK
31SH	6	15.2	12



SNAIL FORK

Stainless steel with a black plastic handle.

ITEM	LENGTH		PACK
	IN	CM	
3010	7	17.8	12



NUT & LOBSTER CRACK

Comfortable grip and smooth opening hinge makes cracking quick and effortless.

ITEM	LENGTH		PACK
	IN	CM	
5524	5	12.7	12



LOBSTER CRACKS

Made of drop-forged steel with a satin finish.

ITEM	DESCRIPTION	LENGTH		PACK
		IN	CM	
526C	Chrome	6	15.2	24
530LC	Stainless Steel	6	15.2	12



TABLE CRUMBER

Gold anodized aluminum with a pocket clip. Helps maintain table top free of crumbs.

ITEM	LENGTH		PACK
	IN	CM	
TC896	6	15.2	12



LOBSTER CRACK

Cast steel body with smooth nickel-plated finish.

ITEM	DESCRIPTION	LENGTH		PACK
		IN	CM	
527N	Nickel	5 3/4	14.6	12



TALL MENU & CARD HOLDER

Tightly wound spring wire holds card on top of a chrome-plated steel stand.

ITEM	HEIGHT		PACK
	IN	CM	
4145	12	30.5	12
4155	15	38.1	12
4165	18	45.7	12



MENU/CARD HOLDER

Nickel-plated, heavy spring steel wire on a heavy base.

ITEM	HEIGHT		BASE DIAMETER		
	IN	CM	IN	CM	PACK
4107	2 1/4	5.7	2 1/4	5.7	24

MENU/CARD HOLDER

Nickel-plated, tightly wound spring wire welded to steel base.



ITEM	HEIGHT		BASE DIAMETER		
	IN	CM	IN	CM	PACK
548	2 1/2	6.4	2 1/4	5.7	24

MENU/CARD HOLDER

Stainless steel spring clip on a stamped base.



ITEM	HEIGHT		BASE DIAMETER		
	IN	CM	IN	CM	PACK
4115	2	5.1	2 1/4	5.7	24



MENU/CARD HOLDER

Chrome-plated with stylish modern design on a weighted base.

ITEM	HEIGHT		BASE DIAMETER		
	IN	CM	IN	CM	PACK
4125	1 1/2	3.8	1 1/8	2.9	12



MENU COVER

Vinyl plastic with heat sealed edges. Inside pockets are clear cellulose acetate. Cover furnished with printed menu inserts.

ITEM	COLOR	IN	CM	PACK
101B	Black	7 x 9 1/2	17.8 x 24.1	24
101R	Red	7 x 9 1/2	17.8 x 24.1	24
103B	Black	8 1/4 x 12	21 x 30.5	24
103R	Red	8 1/4 x 12	21 x 30.5	24



MENU COVER

Celluloid faces, leatherette binding, and reinforced corners available with black, blue or red binding.

GUEST CHECK COVER

Black plastic, heat-sealed edges with two inside pockets.

ITEM	IN	CM	PACK
GC105B	5 1/2 x 10 1/4	14 x 26	12

ITEM	STYLE	BINDING COLOR	IN	CM	PACK
69B	Single	Black	6 1/2 x 9	16.5 x 22.9	24
69	Single	Blue	6 1/2 x 9	16.5 x 22.9	24
69R	Single	Red	6 1/2 x 9	16.5 x 22.9	24
70MCB	Double	Black	6 1/2 x 9	16.5 x 22.9	24
70MCBL	Double	Blue	6 1/2 x 9	16.5 x 22.9	24
70MCR	Double	Red	6 1/2 x 9	16.5 x 22.9	24
712B	Double	Black	7 1/2 x 11	19.1 x 27.9	24
712BL	Double	Blue	7 1/2 x 11	19.1 x 27.9	24
712R	Double	Red	7 1/2 x 11	19.1 x 27.9	24



MENU COVER

Clear vinyl protects paper menus from smears and spills.

ITEM	COLOR	IN	CM	PACK
107	Double (No Binding)	8 3/4 x 11 1/2	22.2 x 29.2	24

MENU COVER

Protects menus from water damage and spills.

ITEM	SHEET STYLE	IN	CM	PACK
79901	Single	9 1/4 x 12	23.5 x 30.5	25
79921	Double	8 1/2 x 11	21.6 x 27.9	25
79941	Triple	8 1/2 x 11	21.6 x 27.9	25

Baskets

Show off bread, wine, and appetizers with our vast selection, including everything from natural bamboo to polypropylene, for every restaurant need. All baskets are made from high quality materials designed to serve your customers well for many years.



WILLOW BREAD BASKET

Made of split willow in a buff color.

ITEM	SHAPE	DIMENSIONS (L x W x H) (D x H)		PACK
		IN	CM	
4459	Round	9 x 3	2.9 x 7.6	12
4497	Oval	9 x 7 x 3	22.9 x 17.8 x 7.6	12



BAMBOO BASKET

Tightly woven, narrow strand basket in a natural color that can be used to serve bread, rolls, and crackers.

ITEM	SHAPE	DIMENSIONS (L x W x H) (D x H)		PACK
		IN	CM	
CH420	Oval	9 x 6 3/4 x 2 1/2	22.9 x 17.1 x 6.4	12
CH485	Round	8 x 3	20.3 x 7.6	12



BREAD BASKET

Rattan core in a natural color.

ITEM	SHAPE	DIMENSIONS (L x W x H) (D x H)		PACK
		IN	CM	
2234BB	Oval	8 1/2 x 6 3/4 x 3	21.6 x 17.1 x 7.6	12
2254	Round	8 x 2 1/2	20.3 x 6.3	12



BREAD BASKET

Wide strand, split bamboo in a natural color.

ITEM	SHAPE	DIMENSIONS (L x W x H) (D x W)		PACK
		IN	CM	
420	Oval	9 x 6 3/4 x 2 1/2	22.9 x 17.1 x 6.3	12
485	Round	8 x 2 1/2	20.3 x 6.3	12



CRACKER BASKET

Rattan core, natural color basket for serving bread, rolls, and crackers.



ITEM	DIMENSIONS (H x L x W)		PACK
	IN	CM	
2208	2 3/4 x 8 1/2 x 3	7 x 21.6 x 7.6	12



8859



8879



8869



8889

POLYPROPYLENE BASKET

Wire reinforced tops, bottoms, and ribs. Odorless and dishwasher safe.

ITEM	SHAPE	DIMENSIONS (L x W x H) (D x H)		PACK
		IN	CM	
8859	Round	8 x 2 1/4	20.3 x 5.7	144
8869	Oblong	8 3/4 x 3 x 2	22.2 x 7.6 x 5.1	144
8879	Oval	9 x 6 3/8 x 3	22.9 x 16.2 x 7.6	144
8889	Long	15 x 5 1/2 x 3	38.1 x 14 x 7.6	144
8899	Rectangular	9 x 7 x 2 3/4	22.9 x 17.8 x 9.5	144



8899



BASKET

Black vinyl in an oval shape with gold rim.

ITEM	SHAPE	DIMENSIONS (L x W x H)		PACK
		IN	CM	
599	Oval	9 1/4 x 6 1/2 x 2 3/4	23.5 x 16.5 x 7	144



BASKET

Black and gold cracker basket.

ITEM	DIMENSIONS (L x W x H)		PACK
	IN	CM	
532BV	9 x 3 1/2 x 2	22.9 x 8.9 x 5.1	144



BASKET

Black vinyl in round shape with gold rim.

ITEM	SHAPE	DIMENSIONS (L x W x H)		PACK
		IN	CM	
589BG	Round	8 1/4 x 2 3/4	20.9 x 7	144

Flatware

Table settings reflect a restaurant's reputation. Whether a restaurant's flatware is wrapped in linen napkins or bulk bins, Alegacy's practical and classic 18/0 stainless designs shine for you.

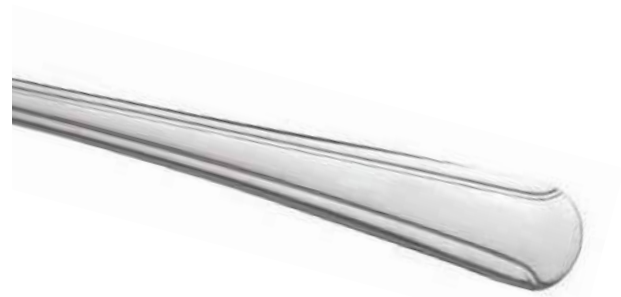

DOMINION PATTERN

ITEM	DESCRIPTION	LENGTH		PACK
		IN	CM	
MEDIUM WEIGHT				
5500W	Knife-Wave Cut	7 7/8	20	2/36 dz
5502	Teaspoon	6	15.2	2/36 dz
5503	Fork	7	17.8	2/36 dz
5504	Dessert Spoon	6 3/4	17.1	2/36 dz
5505	Demitasse Spoon	4 3/4	12.1	2/36 dz
5506	Iced Tea Spoon	7 1/2	19.1	2/36 dz
5507	Oyster Fork	6 1/4	15.9	2/36 dz
5508	Salad Fork	6 1/4	15.9	2/36 dz
5509	Bouillon Spoon	5 5/8	14.3	2/36 dz
5510	Tablespoon	7 5/8	19.4	2/36 dz

ITEM	DESCRIPTION	LENGTH		PACK
		IN	CM	
HEAVY WEIGHT				
2500	Knife-Wave Cut	8	20.3	2/36 dz
2502	Teaspoon	5 7/8	14.9	2/36 dz
2503	Fork	7	17.8	2/36 dz
2504	Dessert Spoon	7	17.8	2/36 dz
2506	Iced Tea Spoon	7 5/8	19.4	2/36 dz
2507	Oyster Fork	5 1/2	14	2/36 dz
2508	Salad Fork	6 1/8	15.6	2/36 dz
2510	Cream Soup Spoon	5 7/8	14.9	2/36 dz



WINDSOR PATTERN

ITEM	DESCRIPTION	LENGTH		
		IN	CM	PACK
MEDIUM WEIGHT				
5900	Knife-Wave Cut	7 7/8	20	3/36 dz
5602	Teaspoon	6	15.2	3/36 dz
5603	Fork	7 1/8	18.1	3/36 dz
5604	Dessert Spoon	6 7/8	17.5	3/36 dz
5605	Demitasse Spoon	4 3/4	12.1	2/36 dz
5606	Iced Tea Spoon	7 1/2	19.1	3/36 dz
5607	Oyster Fork	6 1/4	15.9	3/36 dz
5608	Salad Fork	6 1/4	15.9	3/36 dz
5609	Bouillon Spoon	6 1/4	15.9	3/36 dz
5610	Tablespoon	7 5/8	19.4	3/36 dz

ITEM	DESCRIPTION	LENGTH		
		IN	CM	PACK
HEAVY WEIGHT				
2900	Knife-Wave Cut	8 3/8	21.3	2/36 dz
2902	Teaspoon	5 7/8	14.9	2/36 dz
2903	Fork	7	17.8	2/36 dz
2904	Dessert Spoon	7	17.8	2/36 dz
2906	Iced Tea Spoon	8	20.3	2/36 dz
2907	Oyster Fork	6 1/4	15.9	2/36 dz
2908SF	Salad Fork	6 1/8	15.6	2/36 dz
2909	Bouillon Spoon	6 1/4	15.9	2/36 dz





REGINA PATTERN

Heavy weight with mirror polished finish.

ITEM	DESCRIPTION	LENGTH		PACK
		IN	CM	
3300W	Knife-Wave Cut	8 1/4	21	3/36 dz
3302	Teaspoon	6 1/8	15.6	3/36 dz
3303	Fork	7 1/2	19.1	3/36 dz
3304	Dessert Spoon	7	17.8	3/36 dz
3306	Iced Tea Spoon	8	20.3	3/36 dz
3307	Oyster Fork	5 1/2	14	3/36 dz
3308	Salad Fork	6 1/4	15.9	3/36 dz
3310	Cream Soup Spoon	6	15.2	3/36 dz



EXCLUSIVE PATTERN

Extra heavy weight with satin finished handles and mirror polished serving portions.

ITEM	DESCRIPTION	LENGTH		PACK
		IN	CM	
6600	Knife-Wave Cut	8 1/4	21	3/36 dz
6602	Teaspoon	6 1/8	15.6	3/36 dz
6603	Fork	7 1/8	18.1	3/36 dz
6604	Dessert Spoon	7 1/8	18.1	3/36 dz
6606	Iced Tea Spoon	7 1/2	19.1	3/36 dz
6607	Oyster Fork	5 1/2	14	3/36 dz
6608	Salad Fork	6 1/4	15.9	3/36 dz
6610	Cream Soup Spoon	6	15.2	3/36 dz



SWEDISH MODERN PATTERN

Heavy weight with satin finish handles and mirror polished serving portions.

ITEM	DESCRIPTION	LENGTH		PACK
		IN	CM	
1500K	Knife-Wave Cut	8 1/4	21	3/36 dz
1502	Teaspoon	6	15.2	3/36 dz
1503	Fork	7	17.8	3/36 dz
1504	Dessert Spoon	7	17.8	3/36 dz
1506	Iced Tea Spoon	7 1/2	19.1	3/36 dz
1507	Oyster Fork	5 1/2	14	3/36 dz
1508SF	Salad Fork	6 1/4	15.9	3/36 dz
1510SS	Cream Soup Spoon	6	15.2	3/36 dz



PEBBLE PATTERN

Heavy weight with mirror polished finish.

ITEM	DESCRIPTION	LENGTH		PACK
		IN	CM	
1600W	Knife	8 1/2	21.6	3/36 dz
1602	Teaspoon	6	15.2	3/36 dz
1603	Fork	7 3/8	18.7	3/36 dz
1604	Dessert Spoon	7 1/8	18	3/36 dz
1606	Ice Teaspoon	7 3/8	18.7	3/36 dz
1607	Oyster Fork	5 3/4	14.6	3/36 dz
1608	Salad Fork	6 1/4	15.9	3/36 dz
1610	Bouillon Spoon	6 1/8	15.5	3/36 dz



BRIGHTON PATTERN

Heavy weight with satin finished handles and mirror polished serving portions.

ITEM	DESCRIPTION	LENGTH		PACK
		IN	CM	
9900W	Knife	8 3/4	22.2	3/36 dz
9902	Teaspoon	6	15.2	3/36 dz
9903	Fork	7 1/4	18.4	3/36 dz
9904	Dessert Spoon	7 1/8	18.1	3/36 dz
9906	Ice Teaspoon	7 1/8	18.1	3/36 dz
9907	Oyster Fork	5 1/2	14	3/36 dz
9908	Salad Fork	6 3/4	17.1	3/36 dz
9910	Bouillon Spoon	6	15.2	3/36 dz
9911	Hollow Handle Dinner Knife	9	22.5	1/18 dz
9912	Hollow Handle Steak Knife	9	22.5	1/18 dz
9913	Dinner Fork - 4 Tine	7 1/2	19	3/36 dz





JEWEL PATTERN

Extra heavy weight with mirror polished finish.

ITEM	DESCRIPTION	LENGTH		PACK
		IN	CM	
1800W	Knife	8 3/8	21.3	3/36 dz
1801	Teaspoon (Small Bowl)	6 1/4	15.9	3/36 dz
1802	Teaspoon	6	15.2	3/36 dz
1803	Fork	7 3/4	19.7	3/36 dz
1804	Dessert Spoon	6 7/8	17.5	3/36 dz
1806	Ice Teaspoon	7 3/8	18.7	3/36 dz
1807	Oyster Fork	6	15.2	3/36 dz
1808	Salad Fork	6 5/8	16.8	3/36 dz
1810	Bouillon Spoon	6 1/4	15.9	3/36 dz



REGAL PATTERN

Extra heavy weight with mirror polished finish.

ITEM	DESCRIPTION	LENGTH		PACK
		IN	CM	
1400W	Knife	8 3/4	22.2	1/24 dz
1402	Teaspoon	6	15.2	1/24 dz
1403	Fork	7 3/8	18.7	1/24 dz
1404	Dessert Spoon	7 1/8	18.1	1/24 dz
1406	Ice Teaspoon	7 1/2	19	1/24 dz
1407	Oyster Fork	5 1/2	14	1/24 dz
1408	Salad Fork	6 3/4	17.1	1/24 dz
1410	Bouillon Spoon	5 3/4	14.6	1/24 dz



DUCHESS PATTERN

Extra heavy weight with mirror polished finish.

ITEM	DESCRIPTION	LENGTH		PACK
		IN	CM	
1700W	Knife	8 5/8	21.9	1/24 dz
1702	Teaspoon	6	15.2	1/24 dz
1703	Fork	7 3/8	18.7	1/24 dz
1704	Dessert Spoon	7 3/8	18.7	1/24 dz
1706	Ice Teaspoon	7 3/4	19.3	1/24 dz
1707	Oyster Fork	5 3/4	14.6	1/24 dz
1708	Salad Fork	6 3/8	17.5	1/24 dz
1710	Bouillon Spoon	5 7/8	14.9	1/24 dz



SALAD & CHOPPING BOWLS

Hardwood bowls, made in the U.S.A., excellent for chopping and salad preparation.

ITEM	DIAMETER		PACK
	IN	CM	
1209CB	7 1/8	18.1	24
22121	9 3/4	24.8	12
22122	11 3/4	29.8	6
22123	14	35.6	6
22124	16 1/2	41.9	3



1209CB

WOVEN WOOD SALAD BOWLS

Durable wooden bowls are hand woven with a walnut weave and made with melamine for strength and good looks. Will not absorb odors like garlic or oil and are unbreakable in normal use.

ITEM	DIAMETER		DEPTH		PACK
	IN	CM	IN	CM	
3605	5 1/2	14	1 1/4	3.2	12
3606	6	15.2	1 1/2	3.8	12
3608	8	20.3	1 7/8	4.8	12
3610	10	25.4	2 1/2	6.4	12
3612	12	30.5	3 1/4	8.3	12
3614	14	35.6	3 1/4	8.3	12
3616	16	40.6	3 5/8	9.2	12
3618	18	45.7	3 5/8	9.2	12
3620	20	50.8	4 3/8	11.1	12



WOVEN WOOD PLATES & TRAYS

Two styles to compliment the salad bowl service above.

ITEM	DIAMETER		PACK
	IN	CM	
PLATES			
4906	6	15.2	12
4908	8	20.3	12
4909	9	22.9	12
4910	10	25.4	12

TRAYS			
4911	11	27.9	12
4912	12	30.5	12
4913	13	33	12



SALAD FORK & SPOON SET

Made of woven wood to complement the salad bowls.

ITEM	LENGTH		PACK
	IN	CM	
013010	10	25.4	12



Insulated Pitchers

Swirl pattern coffee servers keep beverages hot or cold for hours. Each pitcher can be customized for easy identification with orange tabs for decaf, brown for regular, and green for tea. The BPA-free polypropylene liner is durable and stain resistant, and the porcelain-like exterior is made of impact-resistant ABS plastic for durability. Also available with a built-in thermometer for temperature control.



INSULATED PITCHERS – TWIST CAP

Porcelain looking pitchers are available in white or black. Tea/Decaf/Regular tab indicators are included.

ITEM	COLOR	CAPACITY		HEIGHT		PACK
		OZ	ML	IN	CM	
IP4022W20B	White	20	591	7 1/2	19.1	1
IP4022W40B	White	40	1182	9 1/2	24.1	1
IP4022B20B	Black	20	591	7 1/2	19.1	1
IP4022B40B	Black	40	1182	9 1/2	24.1	1



INSULATED PITCHERS WITH BUILT-IN THERMOMETERS

The convenient push button top is now also enhanced with a built-in dial thermometer to read beverage temperature (40 - 220°F).

ITEM	COLOR	CAPACITY		HEIGHT		PACK
		OZ	ML	IN	CM	
IP4022W40PTH	White	40	1182	9 1/2	24.1	1
IP4022W64PTH	White	64	1892.5	11 1/4	28.6	1
IP4022B40PTH	Black	40	1182	9 1/2	24.1	1
IP4022B64PTH	Black	64	1892.5	11 1/4	28.6	1



INSULATED PITCHERS – PUSH BUTTON

Pour beverages with greater ease thanks to a convenient push button function.



ITEM	COLOR	CAPACITY		HEIGHT		PACK
		OZ	ML	IN	CM	
IP4022W20P	White	20	591	7 1/2	19.1	1
IP4022W40P	White	40	1182	9 1/2	24.1	1
IP4022W64P	White	64	1892.5	11 1/4	28.6	1
IP4022B20P	Black	20	591	7 1/2	19.1	1
IP4022B40P	Black	40	1182	9 1/2	24.1	1



PITCHER WITH ICE CORE

Freezable ice core keeps beverages colder for longer without dilution. Twist-and-lock core makes for secure pouring and quick replacement. Features a sturdy, ergonomic handle for ease of use and is dishwasher safe.

ITEM	COLOR	CAPACITY		HEIGHT		PACK
		OZ	L	IN	CM	
IP403520	Clear	68	2	9	22.9	1
IP402520BL	Blue	68	2	8 1/2	21.6	1
IP402520G	Green	68	2	8 1/2	21.6	1
IP402520R	Red	68	2	8 1/2	21.6	1
IP402520Y	Yellow	68	2	8 1/2	21.6	1



COFFEE DECANTER

Polished stainless steel with plastic handle and a 12-cup capacity. Handle choice is black for regular and orange for decaf.

ITEM	DESCRIPTION	CAPACITY		HEIGHT		PACK
		OZ	ML	IN	CM	
LC15B	Black Handle	64	1892.5	6 1/2	16.5	1
LC15O	Orange Handle	64	1892.5	6 1/2	16.5	1



PLASTIC DECANTER

Excellent for serving coffee or water. Stainless steel base is lightweight and more resistant to breakage. Available in black handle for regular coffee and orange handle for decaf.

ITEM	CAPACITY		HEIGHT		PACK
	QT	L	IN	CM	
50982	2	1.9	6 3/4	17.1	1
50982D	2	1.9	6 3/4	17.1	1



COFFEE DISPENSERS

Perfect for buffet service, conference break tables, and other coffee service applications, our portable coffee dispenser fills from coffee machines and is available in plastic or stainless steel finish.

ITEM	DESCRIPTION	CAPACITY		HEIGHT		PACK
		QT	L	IN	CM	
CD1	Stainless Steel	2 2/3	2.5	20	50.8	1
CD2	Plastic	2 2/3	2.5	20	50.8	1

AIR POTS

Beverage service has never been easier with these lever-pump units in four convenient sizes. Stainless steel lined interior and brushed stainless exterior. Available for regular or decaf service.

ITEM	DESCRIPTION	CAPACITY		HEIGHT		PACK
		QT	L	IN	CM	
AP200	Regular	2 1/8	2	12 1/4	31.1	1
AP200D	Decaf	2 1/8	2	12 1/4	31.1	1
AP250	Regular	2 3/5	2.5	13 1/4	33.7	1
AP250D	Decaf	2 3/5	2.5	13 1/4	33.7	1
AP300	Regular	3 1/8	3	14 1/2	36.8	1
AP300D	Decaf	3 1/8	3	14 1/2	36.8	1
AP350	Regular	3 3/4	3.5	15 3/4	40	1
AP350D	Decaf	3 3/4	3.5	15 3/4	40	1





Insulated Servers

Stainless Steel lined servers keep liquids hot or cold for a variety of service needs.



CFS10

CARAFES

Push button coffee service is made easy. Attractive brush stainless exterior.



ITEM	CAPACITY		HEIGHT		PACK
	OZ	ML	IN	CM	
e™ CFS10	34	1000	7 1/2	19.1	1
CFS120	40	1182	7 3/4	19.7	1
CFS150	51	1500	8 1/2	21.6	1
CFS200	68	2000	9 3/4	24.8	1

COFFEE SERVERS

Push button or Bru-Thru design keeps coffee hot for many hours of inservice use.

ITEM	DESCRIPTION	CAPACITY		HEIGHT		PACK
		OZ	ML	IN	CM	
e™ CS40	Push Button	40	1182	8 1/8	20.6	1
CS64	Push Button	64	1892.5	9 7/8	25.1	1
CS64BT	Bru-Thru w/ Regular & Decaf Lid	64	1892.5	7	17.8	1



SSF70

FLASK SERVERS

Flip top design allows for easy pouring of liquids.

ITEM	CAPACITY		HEIGHT		PACK
	OZ	ML	IN	CM	
e™ SSF70	24	700	9	22.9	1
SSF100	34	1000	11 1/2	29.2	1



AP25



AP25D

AIR POTS

Stainless steel lined interior and brushed stainless exterior. Available in two sizes for regular and decaf service.

ITEM	DESCRIPTION	CAPACITY		HEIGHT		PACK
		QT	L	IN	CM	
e™ AP25	Regular	2 3/5	2.5	16	40.6	1
AP25D	Decaf	2 3/5	2.5	16	40.6	1
AP30	Regular	3 1/8	3	17	43.2	1
AP30D	Decaf	3 1/8	3	17	43.2	1



SS100



SS70

CREAM SERVERS

Easy pouring of cream for coffee service.

ITEM	CAPACITY		HEIGHT		PACK
	OZ	ML	IN	CM	
e™ SS70	24	700	9	22.9	1
SS100	34	1000	11	27.9	1

e™ All items on this page are part of our economy line offerings, identified by our green e-line icon and matching color-coded chart items.



COFFEE POT

Made of 18/8 stainless steel with a gadroon base.

ITEM	CAPACITY		HEIGHT		
	OZ	ML	IN	CM	PACK
S825	32	946.2	6 1/4	15.9	1
S950	64	1892.5	8 1/2	21.6	1



GOOSENECK TEAPOT

The stainless steel teapot features a hinged lid with heat insulating hollow handle for comfortable pouring. Easy to clean and will not stain.

ITEM	CAPACITY		HEIGHT		
	OZ	ML	IN	CM	PACK
CT1	10	296	3 5/8	9.2	12

BELL-SHAPED PITCHER

18/8 stainless steel with tubular handle.

ITEM	DESCRIPTION	QT	CAPACITY		HEIGHT		PACK
			L	IN	CM		
8202		2 1/8	2	8	20.3	1	
8203		3 1/8	3	9	22.9	1	
8202G	w/ Ice Guard	2 1/8	2	8	20.3	1	
8203G	w/ Ice Guard	3 1/8	3	8 1/2	21.6	1	



WATER PITCHER

18/8 stainless steel with convenient ice guard and gadroon base.

ITEM	CAPACITY		HEIGHT		
	OZ	ML	IN	CM	PACK
S980	64	1892.5	7 1/4	18.4	1



FROTHING PITCHER

Stainless construction with heat-resistant handle design. Molded spout makes for easy pouring into any espresso based drink.

ITEM	CAPACITY		HEIGHT		
	OZ	ML	IN	CM	PACK
FC150	5	150	2 1/4	5.7	1
FC350	12	350	3 5/8	9.2	1
FC600	20	600	4 3/8	11.1	1
FC1000	33	1000	4 3/4	12.1	1
FC2000	67	2000	6 7/8	17.5	1



SAUCE CUP

Stainless steel with a mirror, hammered, or ribbed finish outside and satin finish inside. Plain rolled edge ideal for sauces, butter or condiments.

ITEM	STYLE	CAPACITY		HEIGHT		PACK
		OZ	ML	IN	CM	
650012	Plain	1 1/2	44.6	2 3/8	6	12
650012H	Hammered	1 1/2	44.6	2 3/8	6	12
650012R	Ribbed	1 1/2	44.6	2 3/8	6	12
6500	Plain	2 1/2	74	2 3/8	6	12
6500H	Hammered	2 1/2	74	2 3/8	6	12
6500R	Ribbed	2 1/2	74	2 3/8	6	12
65004	Plain	4	118.3	3	7.6	12
65004H	Hammered	4	118.3	3	7.6	12
65004R	Ribbed	4	118.3	3	7.6	12



STAINLESS STEEL PAILS

Versatile for serving a variety of appetizers and enhances tabletop presentation. Offered in three sizes: Small, Medium and Large.

ITEM	DESCRIPTION	IN	CM	PACK
SSP1	Mirror Finish - Small	2 3/4 x 2 1/2	7 x 6.3	12
SSP2	Mirror Finish - Medium	3 1/4 x 3 1/4	8.2 x 8.2	12
SSP3	Mirror Finish - Large	5 x 4 1/2	12.7 x 11.4	12
SSPH1	Hammered Finish - Small	2 3/4 x 2 1/2	7 x 6.3	12
SSPH2	Hammered Finish - Medium	3 1/4 x 3 1/4	8.2 x 8.2	12
SSPH3	Hammered Finish - Large	5 x 4 1/2	12.7 x 11.4	12



STAINLESS STEEL FRY CUPS

This collection is offered in both a brushed stainless and hammered stainless finish. Versatile for serving fries, potato and vegetable wedges.

ITEM	DESCRIPTION	IN	CM	PACK
FFCH10	Hammered finish	3 3/8 x 3 3/8	8.6 x 8.6	12
FFCS10	Satin finish	3 3/8 x 3 3/8	8.6 x 8.6	12
FFCHA10	Angled hammered finish	3 1/8 x 4 3/8	7.9 x 11.1	12
FFCSA10	Angled satin finish	3 1/8 x 4 3/8	7.9 x 11.1	12

BELL CREAMER

Bell shaped stainless steel with mirror finish. Six convenient sizes for serving cream or syrup.

ITEM	CAPACITY		HEIGHT		PACK
	OZ	ML	IN	CM	
SH269	1 1/2	44.4	1 1/2	3.8	12
SH270	3	89	2 1/4	5.7	12
SH271	5	148	2 3/4	7	12
SH272	8	231	3 1/8	7.9	12
SH273	12	354.8	3 3/8	8.6	12
SH274	16	473.1	3 3/4	9.5	12



STAINLESS STEEL TEAPOT/CREAMER

Economy server made of stainless steel, provides ease of service.



ITEM	CAPACITY		HEIGHT		PACK
	OZ	ML	IN	CM	
S202	10	296	4 1/8	10.5	12

DELUXE FOOTED CREAMER

18/8 stainless steel with gadroon base.



ITEM	CAPACITY		HEIGHT		PACK
	OZ	ML	IN	CM	
S514	5	148	3 1/2	8.9	12



STACKING TEAPOT/CREAMER

Stainless steel server with flat recessed top allows for easy stacking.

ITEM	CAPACITY		HEIGHT		PACK
	OZ	ML	IN	CM	
S3202	10	296	3 1/4	8.3	12



GRAVY BOAT

Stainless steel with mirror finish inside and outside, with a gadroon base. Available in a wide assortment of sizes for serving gravies, sauces, and salad dressings.

ITEM	CAPACITY		
	OZ	ML	PACK
1103GB	3	89	12
1105	5	148	12
1108	8	237	12

GRAVY BOAT WITH STEPPED BOTTOM

Update your gravy boat from a "Jurassic" to a classic. Made of the highest quality 18/8 stainless steel and featuring a highly polished mirrored finish, this boat adds a touch of class to any event. The tri-stepped bottom creates an elegant serving piece for your finest sauces and gravies.

ITEM	CAPACITY		
	OZ	ML	PACK
2108	8	237	12
2110	10	296	12
2116	16	473.6	12





SUPREME BOWL

Stainless steel with a mirror finish and a gadroon base. Ideal for shrimp cocktail.



ITEM	DESCRIPTION	TOP DIAMETER		HEIGHT		PACK
		IN	CM	IN	CM	
795C	Complete Unit	5 1/4	13.3	3 1/4	8.2	1
795B	Bowl Only					12
5280	Ring Only					12



SHERBET/SUNDAE DISH

Stainless steel with a mirror finish, paneled top edge, and a gadroon base.

ITEM	CAPACITY		HEIGHT		PACK
	OZ	ML	IN	CM	
1043	3 1/2	103.5	1 1/2	3.8	12
1045	5	147.9	1 1/2	3.8	12

JELLO/SHRIMP CUP

Stainless steel with a mirror finish. Also sold as part of 795C complete.

ITEM	CAPACITY		HEIGHT		PACK
	OZ	ML	IN	CM	
2690	4	118.3	1 1/4	3.2	12



TULIP SUNDAE DISH

Stainless steel with a mirror finish and a gadroon base.

ITEM	CAPACITY		HEIGHT		PACK
	OZ	ML	IN	CM	
1060	6	177.4	4 1/4	10.8	12

ICE CREAM CUP

Take ice cream to the extreme. 18/8 stainless steel and finished with a high mirror polish these cups are ideal for an elegant dessert service.

ITEM	CAPACITY		HEIGHT		PACK
	OZ	ML	IN	CM	
2100	4	118.4	2 3/16	5.6	12





2983

OVAL AU GRATIN DISH

Stainless steel with a mirror finish.

ITEM	CAPACITY		DIMENSIONS (L x W x H)		
	OZ	ML	IN	CM	PACK
2981	8	236.6	8 x 4 1/2 x 7/8	20.3 x 11.4 x 2.2	12
2982GD	12	354.8	9 x 5 x 1	22.9 x 12.7 x 2.5	12
2983	20	591.4	11 x 6 3/8 x 1 1/8	27.9 x 16.2 x 2.9	12

OVAL SERVING PLATTER

Stainless steel with a mirror finish and straight cut edge.

ITEM	DIMENSIONS (L x W)		
	IN	CM	PACK
105237	14 x 9	35.6 x 22.9	12
105241	16 1/4 x 10 5/8	41.3 x 27	12
105246	18 1/4 x 11 5/8	46.4 x 29.5	12
105254	21 3/8 x 13 3/8	54.3 x 34	12



2984

ROUND AU GRATIN DISH

Stainless steel with a mirror finish.

ITEM	CAPACITY		DIMENSIONS (D x H)		
	OZ	ML	IN	CM	PACK
2984	6	177.4	5 1/2 x 3/4	13.9 x 1.9	12
2985	8	236.6	5 3/4 x 3/4	14.6 x 1.9	12
2986	10	295.7	6 1/4 x 3/4	15.9 x 1.9	12



59028



59025



59016

CATER TRAYS

Large trays are ideal for serving or displaying foods in buffet lines. High rimmed.

ITEM	SHAPE	DIMENSIONS (L x W)		HANDLES	TRIM	PACK
		IN	CM			
59001	Octagonal	20 x 13 3/4	50.8 x 34.9	No	Plain	12
59004	Oval	17 3/4 x 13	45.1 x 33	No	Plain	12
59007	Oval	18 x 11	45.7 x 27.9	No	Gold	12
59010	Oval	14 1/2 x 9	36.8 x 22.9	No	Gold	12
59013	Rectangular	19 1/2 x 12 1/4	49.5 x 31.1	Yes	Plain	12
59016	Round	14	35.6	No	Plain	12
59019	Octagonal	17 x 11 3/4	43.2 x 29.8	No	Plain	12
59022	Octagonal	20 x 13 3/4	50.1 x 34.9	No	Plain	12
59025	Oval	18 x 13 1/2	45.7 x 34.3	No	Plain	12
59028	Rectangular	20 1/2 x 14	52.1 x 35.6	Yes	Gold	12
59031	Oval	12 1/2 x 9	31.8 x 22.9	No	Gold	12
59034	Rectangular	23 1/4 x 14	59.1 x 35.6	Yes	Gold	12
59037	Rectangular	21 x 12 1/2	53.3 x 31.8	Yes	Gold	12
59040	Round	12	30.5	No	Gold	12



SERVING TRAY

Designed for serving or display, these trays will withstand years of use. Stainless steel finish well suited for serving celery, carrots, olives or bread.

ITEM	DIMENSIONS (L x W x H)		
	IN	CM	PACK
51140	9 x 4 1/2 x 1 1/4	22.7 x 11.4 x 3.2	12
51143	11 x 5 3/4 x 1 1/2	27.9 x 14.6 x 3.8	12



TACO HOLDER

Perfect for tableside service of tacos. Four convenient sizes.

ITEM	IN	CM	PACK
TH1	5 3/4 X 4 X 2	14.6 X 10.1 X 5	12
TH23	8 3/8 X 4 X 2	21.3 X 10.1 X 5	12
TH34	11 3/8 X 4 X 2	28.9 X 10.1 X 5	12
TH45	14 1/8 X 4 X 2	35.8 X 10.1 X 5	12



STEAK PLATTER

Extra-heavy gauge stamped aluminum, highly polished in an oval shape.

ITEM	FITS WOOD UNDER LINER	IN	CM	PACK
561DC	61	7 x 10 1/2	17.8 x 26.7	12
562DC	62WU	8 x 11 1/2	20.3 x 29.2	12
563DC	63	8 1/2 x 12 1/2	21.6 x 31.8	12



WOODEN UNDER LINER

Made of kiln-dried hardwood, shaped to receive steak platters.

ITEM	FITS PLATTER	IN	CM	PACK
61	561DC	8 1/4 x 12	21 x 30.5	12
62WU	562DC	8 5/16 x 12 1/2	21.1 x 30.5	12
63	563DC	9 1/2 x 13 1/2	24.1 x 34.3	12

OVAL CAST IRON PLATTERS

A unique prep and serve combination. Cook-all, serve-all oval cast iron skillets to be used with solid wood oval serving trivet or rattan under liner. Platter is 15" (38.1 cm) overall length.



ITEM	IN	CM	PACK
BG77P	9 1/4 x 7 1/2	23.5 x 19.1	1
BG78P	9 1/2 x 7	24.1 x 17.8	12

OVAL RATTAN UNDER LINER

Protects tables from damage. Fits oval cast iron platter shown above.

ITEM	IN	CM	PACK
BG78R	11 x 8	27.9 x 20.3	12



BAKING SHELL

Imported, natural baking shell for cooking and/or serving individual portions.

ITEM	DIAMETER		PACK
	IN	CM	
663	4 1/2	11.4	36
664	5	12.7	36
665	5 1/2	14	36

OVAL WOOD SERVING TRIVET

Protects and safely serves foods to the table. Fits oval cast iron platter shown above.

ITEM	IN	CM	PACK
BG78U	12 1/2 x 8	13.8 x 20.3	12





STAINLESS STEEL PLATTER WITH UNDER LINER

Oval stainless steel platters with bakelite under liner.

ITEM	SHAPE	IN	CM	PACK
SO128PU	Oval	11 5/8 x 7 3/4	29.5 x 19.7	1
SR117PU	Rectangular	10 7/8 x 7 1/8	27.6 x 18	1



HANDLE SLEEVE

Slip-on sleeve for safe carrying and serving of cast iron pans.

ITEM	LENGTH		PACK
	IN	CM	
AH6	5 1/2	13.9	12



CAST IRON PLATTER & WOODEN UNDER LINER SET

Heavy cast iron, oval platter with hardwood under liner, comes with cast iron handle. Sold in complete sets only.

ITEM	DESCRIPTION	DIMENSIONS		LENGTH		PACK
		IN	CM	IN	CM	
AL172C	Platter	7 1/4 x 10 3/4	18.4 x 27.3			1
	Under Liner	6 5/8 x 12 1/2	16.8 x 31.8			
	Handle			5 1/4	13.3	



PLASTIC STEAK MARKERS

Markers are plastic with molded-in designations. Packed 1,000 per box, 5,000 per case for each designation.

ITEM	DESCRIPTION	COLOR	PACK
SM6R	Rare	Red	1,000
SM6MR	Medium Rare	Pink	1,000
SM6M	Medium	Blue	1,000
SM6MW	Medium Well	Brown	1,000
SM6W	Well	Black	1,000



STAINLESS STEEL SEAFOOD SHELL

For displaying and serving seafood and other side dishes.

ITEM	DIAMETER		
	IN	CM	PACK
51146	5 1/2	14	12

 Economy line offerings are identified by our green e-line icon and matching color-coded chart items.



TORTILLA WARMER

Perfect for heating, serving and storing tortillas.

ITEM	COLOR	DIAMETER		
		IN	CM	PACK
 TW82BRN	Brown	8 1/2	21.6	1
TW82BLK	Black	8 1/2	21.6	1



TOP COUNTER DISPENSER

Holds four cylinders with satin finish.

ITEM	FRONT HEIGHT		BACK HEIGHT		LENGTH		DEPTH		PACK
	IN	CM	IN	CM	IN	CM	IN	CM	
TCD4	5 1/2	14	8 9/16	21.7	10 1/8	25.7	11 3/4	29.8	1



TOP COUNTER DISPENSER

Holds six cylinders with satin finish.

ITEM	FRONT HEIGHT		BACK HEIGHT		LENGTH		DEPTH		PACK
	IN	CM	IN	CM	IN	CM	IN	CM	
TCD6	5 1/2	14	8 3/8	21.3	14 1/2	36.8	11 3/4	29.8	1



TOP COUNTER DISPENSER

Holds eight cylinders with satin finish.

ITEM	FRONT HEIGHT		BACK HEIGHT		LENGTH		DEPTH		PACK
	IN	CM	IN	CM	IN	CM	IN	CM	
TCD8	5 1/2	14	8 9/16	21.7	19 5/8	49.8	11 3/4	29.8	1



TOP COUNTER DISPENSER

Holds four cylinders.

ITEM	FRONT HEIGHT		BACK HEIGHT		LENGTH		DEPTH		PACK
	IN	CM	IN	CM	IN	CM	IN	CM	
TC4S	5 1/2	14	8 9/16	21.7	10 1/8	25.7	11 3/4	29.8	1

TOP COUNTER DISPENSER

Holds six cylinders.

ITEM	FRONT HEIGHT		BACK HEIGHT		LENGTH		DEPTH		PACK
	IN	CM	IN	CM	IN	CM	IN	CM	
TC6S	5 1/2	14	8 3/8	21.3	14 1/2	36.8	11 3/4	29.8	1



TOP COUNTER DISPENSER

Holds eight cylinders.

ITEM	FRONT HEIGHT		BACK HEIGHT		LENGTH		DEPTH		PACK
	IN	CM	IN	CM	IN	CM	IN	CM	
TC8S	5 1/2	14	8 9/16	21.7	19 5/8	49.8	11 3/4	29.8	1

All dispensers, cylinders, and covers are sold separately.



COLD CHEST DISPENSER

Double-wall insulated cabinet of stainless steel with no-mar rubber feet. Can be fixed or portable for use in service areas, back bars, and counters. Keeps perishable food cold and tasty. Easily iced and cleaned with a full-length hinge door making it effortless to charge with ice. The ice surrounds the containers, ensuring quick refrigeration. Containers and covers lift out easily.

ITEM	FRONT HEIGHT		LENGTH		DEPTH		PACK
	IN	CM	IN	CM	IN	CM	
CCLTC4S	6 1/2	16.5	20 1/2	52.1	8 3/8	21.3	1

Specification for complete operational unit: CCLTC4S requires 4 each SC750 containers + 4 each HC20X hinged cover or LO10 lift-off cover.

DISPENSER

In-line dispenser, no-mar rubber feet, holds four cylinders.



ITEM	FRONT HEIGHT		BACK HEIGHT		LENGTH		DEPTH		PACK
	IN	CM	IN	CM	IN	CM	IN	CM	
LTC4S	5 1/4	13.3	7	9.5	19 5/8	49.8	7 1/4	18.4	1

CYLINDER

In-line cylinders used to hold flatware. Made of a variety of materials to meet all needs.



ITEM	DESCRIPTION	DIAMETER		HEIGHT		PACK
		IN	CM	IN	CM	
N200	Nylon-White	4	10.2	5 5/8	14.3	12
RP25W	Polyethylene-White	4	10.2	5 5/8	14.3	12
S500	Stainless Steel	4	10.2	5 5/8	14.3	12
S600	Stainless Steel	4 1/2	11.4	5 1/2	14	12
80104	Polyethylene-White	4 1/4	10.8	5 1/4	13.3	36

FLATWARE BASKET

Holds six cylinders for pin type conveyor rack less machine.

ITEM	DIMENSIONS (L x W x H)			PACK
	IN	CM		
BS65S	14 11/16 x 9 3/16 x 4	37.3 x 23.3 x 10.2		1



All dispensers, cylinders, and covers are sold separately.



LIFT-OFF COVER

Clip type guides hold cover in position. Helps keep food fresh and aids sanitation.

ITEM	DIAMETER		PACK
	IN	CM	
LO10	4 1/2	11.4	12

STAINLESS STEEL HEAVY-DUTY CONTAINER

One piece, no seams.

ITEM	CAPACITY		DIAMETER		HEIGHT		PACK
	OZ	ML	IN	CM	IN	CM	
SC750	30	887.1	4	10.2	5 1/4	13.3	12
S700	30	887.1	4	10.2	5 1/4	13.3	12



HINGED COVER

Ring fits under the rim of the container. Cover can remain up when required or can easily be removed. "See-thru" cover allows easy identification of contents.

ITEM	DIAMETER		PACK
	IN	CM	
HC20X	4 1/2	11.4	12



ALUMINUM ORDER RACK

High quality glass marbles to prevent guest checks from sticking and slipping.

ITEM	LENGTH		
	IN	CM	PACK
OR18	18	45.7	1
OR24	24	61	1
OR36	36	91.4	1
OR48	48	121.9	1

All dispensers, cylinders, and covers are sold separately.

LOW & HIGH BOY CABINETS

Stainless steel interior and exterior, with a drain-off cock, holds all sensitive items refrigerated at point of service. Provides a low cost auxiliary fountain service for fixed or portable use. Easily iced and cleaned with a full-length hinge door, making it effortless to charge with ice. The ice surrounds the containers ensuring quick refrigeration. Convenient side drain for removal of water. Available in 4-jar model. Low Boy holds 2 1/2 qt poly jars and High Boy holds 3 1/2 qt poly jars.



ITEM	FRONT HEIGHT		BACK HEIGHT		LENGTH		DEPTH		PACK
	IN	CM	IN	CM	IN	CM	IN	CM	
IUD4LB	7 3/4	19.7	11	27.9	19 3/4	50.2	11 1/2	29.2	1
IUD4H	10	25.4	12	30.5	20 1/2	52.1	8 3/8	21.3	1

LOW BOY CHOCOLATE & SYRUP PUMPS

Specially designed pump easily dispenses thick liquids and syrups in conjunction with the Low Boy system.

ITEM	CONTENTS	HEIGHT			PACK
		IN	CM	PACK	
SFCP25	Chocolate	13 1/2	34.3	1	
SFP25	Syrup	10 3/4	27.3	1	



SFP25

HIGH BOY CHOCOLATE & SYRUP PUMPS

Specially designed pump easily dispenses thick liquids used in conjunction with the High Boy Cabinet system.

ITEM	CONTENTS	HEIGHT			PACK
		IN	CM	PACK	
LCP35	Chocolate	12 1/4	31.1	1	
LSP35	Syrup	10 3/4	27.3	1	



LCP35

CRUSHED FRUIT & SYRUP JAR

Plastic white jars for fruits and jams with a hinged see-through cover for easy identification of product. Fits cabinets above.

ITEM	DESCRIPTION	CAPACITY		PACK
		OZ	ML	
CFJ250	Jar	2 1/2	73.9	1
RSJ350	Jar	3 1/2	103.5	1
HCJ250	Cover			1





CALL BELL

Durable nickel-plated bell with plastic base makes loud ring.

ITEM	BASE DIAMETER		
	IN	CM	PACK
715	3	7.6	12
725	4	10.2	12



ALEGACY TOOTHPICK DISPENSER

Available in stainless steel or plastic construction for round toothpicks only. Individually boxed.

ITEM	DESCRIPTION	HEIGHT		
		IN	CM	PACK
ALTD5	Stainless Steel	4 1/2	11.4	1
ALTD5PL	Plastic	4 1/2	11.4	1

PLASTIC TOOTHPICK DISPENSER

All-plastic construction with a see-through design.

ITEM	HEIGHT		
	IN	CM	PACK
406S	4 1/2	11.4	12



WRAPPED STRAW DISPENSER

18/8 stainless steel construction, holds a full carton of all types of wrapped straws. Gravity-fed with a suction cup base. Individually boxed.

ITEM	DESCRIPTION	IN	CM	PACK
WSD100	Complete	7 1/8 x 9 1/2 x 6 1/2	18.1 x 24.1 x 16.5	1
WSD100C	Top Plate Only			1



JUMBO STRAW DISPENSER

18/8 stainless steel construction, dispenses straws with an easy finger touch release mechanism. Individually boxed.

ITEM	DESCRIPTION	IN	CM	PACK
ALJ20	Complete	4 1/2 x 10 1/4 x 5 3/4	11.3 x 25.6 x 14.4	1

Butler Tray Stands & Luggage Racks

Tray stands made for easy use and designed to complement any interior. Legs are well-balanced to prevent tipping, fold for convenient storage, and the feet are plastic, which protects carpet and floors.

FOLDING TRAY STAND

Sturdy for all food service needs, particularly large oval serving trays. Stand features heavily tubular steel with replaceable glide and folds for easy handling. Available in chrome finish with washable and replaceable black webbing. Now also available in an economy model.

ITEM	FINISH	PLATFORM LENGTH		WIDTH		O/A HEIGHT		PACK
		IN	CM	IN	CM	IN	CM	
1586	Chrome	19	48.3	16	40.6	31	78.7	6
 1586E	Chrome	19	48.3	16	40.6	32	81.3	6



ALEGACY FOLDING LUGGAGE RACK

Heavy chrome-plated, tubular steel construction has plastic guides and extended rear legs for stability. The black webbing is washable and replaceable.

ITEM	FINISH	PLATFORM LENGTH		WIDTH		O/A HEIGHT		PACK
		IN	CM	IN	CM	IN	CM	
1456C	Chrome	26	66	18	45.7	18 1/2	47	6



ALEGACY HIGH BACK LUGGAGE RACK

Model features a high back to prevent costly damage to walls. Heavy, tubular steel construction has plastic guides and extended rear legs for stability. The black webbing is washable and replaceable. Available in chrome finish.

ITEM	FINISH	PLATFORM LENGTH		WIDTH		O/A HEIGHT		BACK		PACK
		IN	CM	IN	CM	IN	CM	IN	CM	
1476C	Chrome	24 1/2	62.2	17	43.2	16	40.6	25	63.5	6

 Economy line offerings are identified by our green e-line icon and matching color-coded chart items.



WOODEN TRAY STANDS

Dark mahogany finish and has rubber rings for slip-proof stability.

ITEM	PLATFORM LENGTH		WIDTH		HEIGHT		PACK
	IN	CM	IN	CM	IN	CM	
1550	17	43.1	16 1/4	41.2	32 1/2	82.5	1
1551	17	43.1	16 1/4	41.2	32 1/2	82.5	1



1551



1550

DISH CART

Dish cart is stainless steel with 4" (10.2 cm) heavy-duty casters and easy to assemble shelves. 16 x 24" (40.6 x 61 cm).

ITEM	DESCRIPTION	HEIGHT		WIDTH		LENGTH		PACK
		IN	CM	IN	CM	IN	CM	
DC16242	2 Shelves	36	91.4	16	40.6	27 1/2	69.9	1
DC16243	3 Shelves	36	91.4	16	40.6	27 1/2	69.9	1



WOODEN BABY CHAIR

Durable wood has a stain resistant finish and wide stance to prevent tipping. Sold unassembled only.

ITEM	FINISH	OVERALL HEIGHT			PACK
		IN	CM	PACK	
80973	Natural	27 1/4	69.2	1	
80976	Walnut	27 1/4	69.2	1	



80953



80956

BOOSTER SEATS

Rubberwood construction, buckle strap restrains child and provides greater safety. Also comes with additional strap for attaching the seat to the chair.

ITEM	FINISH	O/A HEIGHT			PACK
		IN	CM	PACK	
80953	Natural	10	25.4	1	
80956	Walnut	10	25.4	1	

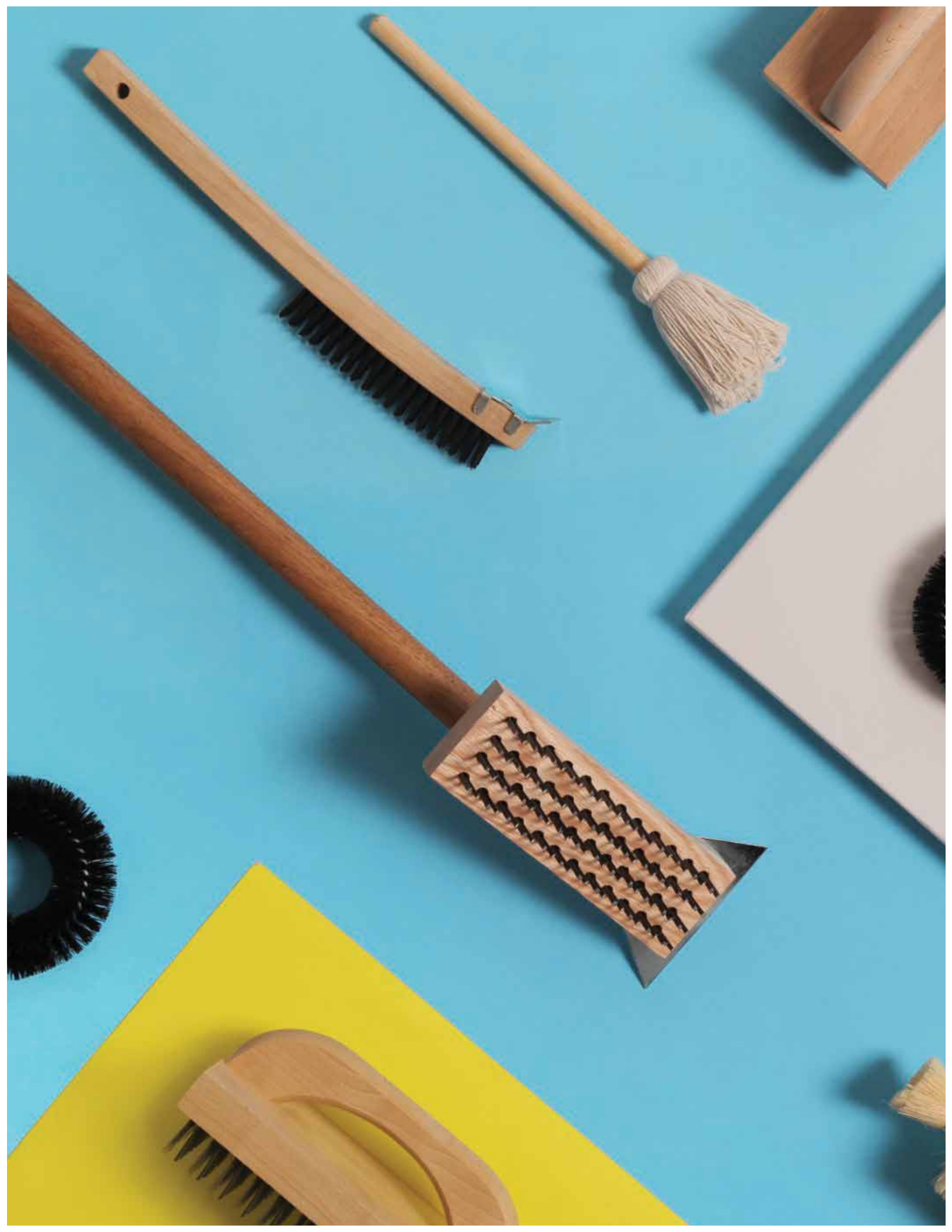

JANITORIAL & BRUSHES

Grill/Oven Brushes

228 - 229

Utility Brushes

230 - 231

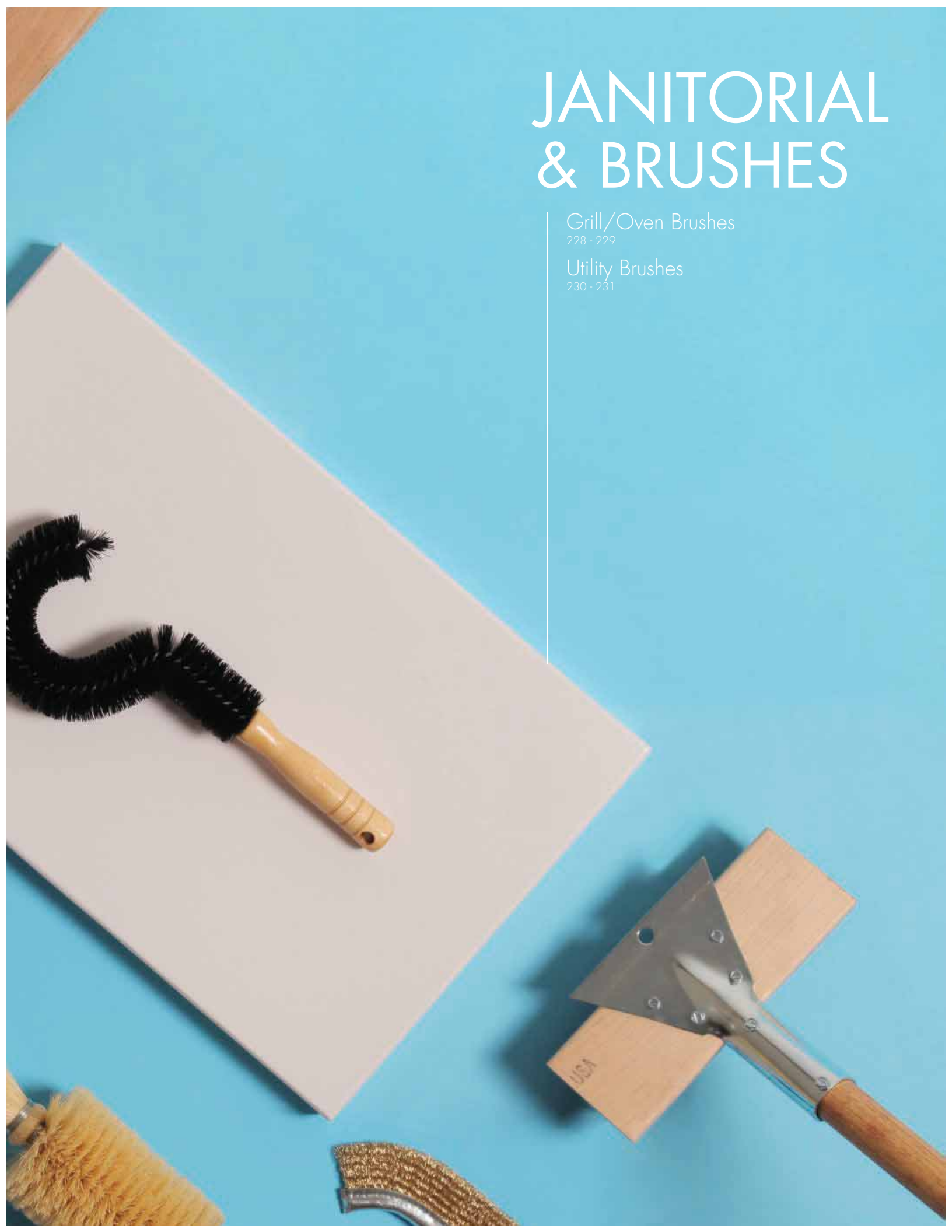



JUMBO BLOCK BRUSH

Hardwood sanded block and handle.

ITEM	IN	CM	PACK
410	9 1/4 x 4 3/4	23.5 x 12.1	12

BLOCK BRUSH

Sanded wooden block with one-inch wire bristle.

ITEM	IN	CM	PACK
424BB	7 x 2	17.8 x 5.1	24

GRILL BRUSH WITH SCRAPER

Brush has firm steel wire bristles with the brush parallel to the handle.

ITEM	HANDLE		BLOCK		PACK
	IN	CM	IN	CM	
GB8700	27	68.6	7 1/2 x 3	19 x 7.6	1



GRILL BRUSH WITH SCRAPER

Brush has flexible steel wire bristles with the brush perpendicular to the handle.

ITEM	HANDLE		BLOCK		PACK
	IN	CM	IN	CM	
GB8702	27	68.6	7 1/2 x 3 3/4	19 x 9.5	1



GRILL/OVEN BRUSH WITH SCRAPER

Brush has firm steel wire bristles with the brush perpendicular to the handle.

ITEM	HANDLE		BLOCK		PACK
	IN	CM	IN	CM	
GB8704	27	68.6	7 1/2 x 3	19 x 17.6	1





GRILL/OVEN BRUSH WITH SCRAPER

Brush has flexible brass wire bristles with the brush perpendicular to the handle.

ITEM	HANDLE		BLOCK		PACK
	IN	CM	IN	CM	
GB8706	27	68.6	7 1/4 x 2 3/8	18.4 x 6	1



GRILL BRUSH WITH SCRAPER

Brush has flexible steel wire bristles with the brush parallel to the handle.

ITEM	HANDLE		BLOCK		PACK
	IN	CM	IN	CM	
GB8708	27	68.6	7 1/4 x 2 1/2	18.4 x 6.3	1



WIRE TAP BRUSH WITH SCRAPER

A hardwood block with 3 x 19 rows of wire bristles.

ITEM	HANDLE		BLOCK		PACK
	IN	CM	IN	CM	
927	14	35.5	6 x 3/4 x 1 3/4	15.2 x 1.9 x 4.4	12



OVEN BRUSH & SCRAPER

Brush is made of brass wire bristles. The steel blade scraper is affixed to a solid maple block.

ITEM	HANDLE		BLOCK		PACK
	IN	CM	IN	CM	
100B	36	91.4	10 x 1 1/2	25.4 x 3.8	12



BROILER/GRILL BRUSH

Cleans grills, grates, and rotisseries with its very stiff wire bristles and ergonomic plastic handle.

ITEM	LENGTH		PACK
	IN	CM	
4203	10 1/2	26.7	12

DISH/GREASE MOP

2 1/2" (6.4 cm) mop of 4-2 ply yarn and a sanded, wooden handle.

ITEM	LENGTH		PACK
	IN	CM	
986	12	30.5	12



COFFEE URN BRUSH

Wire wound, white, tampico bristle head with a wooden handle.

ITEM	HANDLE		BRUSH		PACK
	IN	CM	IN	CM	
903	16 1/2	41.9	5 3/4 x 4 1/2	14.6 x 11.4	12



POT BRUSH

Red palmyra bristles set in a hardwood block.

ITEM	LENGTH		PACK
	IN	CM	
2058	8	20.3	12
20520	20	56.8	12

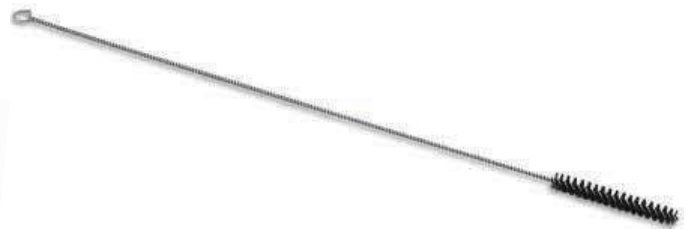

URN GAUGE BRUSH

Twisted wire handle with black fiber bristles.

ITEM	HANDLE		BRUSH		PACK
	IN	CM	IN	CM	
29924	24	61	4 x 1/2	10.2 x 1.3	12



COFFEE DECANTER BRUSH

Black bristles with a wooden handle.

ITEM	LENGTH		PACK
	IN	CM	
298	11 1/2	29.2	24



COUNTER BRUSH

100% sterilized horsehair with a wood handle and 2" (5.1 cm) trim.

ITEM	LENGTH		PACK
	IN	CM	
5158	14	35.6	12

DECK SCRUB BRUSH

Stiff palmyra fiber trimmed to 2 1/4" (5.7 cm) in 7 x 19 rows with a heavy hardwood block.

ITEM	DESCRIPTION	IN	CM	PACK
909	Brush	10 x 2 3/4	25.4 x 7	12
907	Handle Only	54	137	12



EASY GUIDE FOR USING THE ALEGACY CATALOG

All of our products are grouped into one of eleven chapters. In some cases certain products may appear in more than one chapter based on multiple use or foodservice application. Each of our products is shown with relevant specifications. All product dimensions are approximate and may vary. Also, product availability may change without notice. The "Pack" reference for each item is per each and refers to the inner carton, or the convenient order quantity, as applicable. The actual selling unit of measure is stated in our price list. We hope this index helps you reference the depth and breadth of the Alegacy product line. Thank you, again.

ALPHABETICAL INDEX

ITEM	SUB INDEX	PAGE	ITEM	SUB INDEX	PAGE	ITEM	SUB INDEX	PAGE	ITEM	SUB INDEX	PAGE
1 LB. Boat/Food Tray		66	Bouillon Strainers		112	Roll Top		84-87	Butter		138
6 Compartment Mess Tray		141	Bowl Scraper		136	Round	78, 80, 84, 86-87, 90, 94		French Fry		170
Adapter Bar		105	Bowl			Savoir™		76-80	Noodle		171
Air Pots	210-211		Sugar		82	Six in One™		92	Potato Wedge		170
Alegacy Handy-Opener		52	Supreme		215	Sonata Serenade™		84-87	Cutters		
Alegacy Can Opener		124				Top Shelf™		92-95	Cookie		44
Alegacy French Fry Cutter		170	Bowls			Chair, Baby Wooden		225	Dough		44
Alegacy Giant Opener		52	Insulated		116	Cheese Board		151	Pizza		181
Alegacy Knife Sharpener		162	Mixing	115-116		Cheese Plane		88	Cutting Board Cleaning Brushes		149
Alegacy Luggage Rack		224	Salad & Chopping		208	Cheese Shakers	184-185, 190-192		Cutting Board Storage Racks		149
Alegacy Potato Wedge Cutter		170	Woven Wood Salad		208	Cheese Slicer		138	Cutting Boards		148-151
Alegacy Scouring Pad		143	Box, Cutlery	65, 141		Chef Coat		144	Cylinder, Flatware		59, 220
Alegacy Thermometers	174-176		Boxes, Dish 'N Tote		65	Chef's Hat		144	Decanters		210
Alegacy Toothpick Dispensers		223	Braziers	12, 21, 23		Chicken Fryer, Cast Iron		166	Deck Scrub Brush		231
All-Purpose Baster		140	Bread Basket	202-203		China Caps		112	Decorating Comb		40
Aluminum Bake and Roast Pans		29	Brighton Pattern Flatware		206	Chopper, Meat		169	Decorating Set		40
Aluminum Baskets		26	Bread Pans		46	Chrome Tray Stand		224	Decorating Tube Sets		41
Aluminum Blade Pizza Peel		182	Broiler/Grill Brush		229	Citrus Squeezers		55	Deep Ladle		83, 88-89
Aluminum Braziers	12, 21		Brown ABS Handle Knives		153	Clam Knife		161	Deluxe Footed Creamer		214
Aluminum Butter Cutter		138	Brush			Clam Steamer		167	Deluxe Full Size Chafer		90
Aluminum Cheese Slicer		138	Block		228	Cleavers	155, 160		Deluxe Half Size Chafer		90
Aluminum Colander		114	Broiler/Grill		229	Coat, Chef's		144	Deluxe Round Chafer		90
Aluminum Dredges	34, 185		Coffee Decanter		231	Cocktail Parasols		54	Demi Line Ladle		120
Aluminum Egg Wedger		137	Coffee Urn		230	Cocktail Shaker		56	Dial Meat Thermometer		174
Aluminum Fry Bottom		11	Counter		231	Cocktail Strainer		55	Digital Thermometer		175
Aluminum Fry Pans	8-9, 15, 20		Cutting Board Cleaning		149	Coffee Dispensers		210	Dipper		122
Aluminum Muffin/Cup Cake Pans		45	Deck Scrub		231	Coffee Decanter		210	Dippers, Ice Cream		129
Aluminum Order Rack		221	Glass		58	Coffee Decanter Brush		231	Dish 'N Tote Boxes		65
Aluminum Pie Plates		38	Grill w/Scraper	228-229		Coffee Knock Box		102	Dish Cart		225
Aluminum Pizza Screen		181	Grill/Oven	228-229		Coffee Makers		91	Dish		
Aluminum Pizza Trays	17, 170		Oven & Scraper		229	Coffee Pot		212	Au Gratin		216
Aluminum Roast Pans		29	Pastry		42	Coffee Servers	81, 210-211		Oval		216
Aluminum Rolling Pin		43	Pot		230	Coffee Urns		81	Round		216
Aluminum Sauce Pots	7, 14, 19		Urn Gauge		230	Coffee Urn Brush		230	Sherbet/Sundae		215
Aluminum Scoops	36-37, 130-131		Utility	228-229		Colanders		114	Tulip Sundae		215
Aluminum Stock Pots	6-7, 14, 18		Wire Tap w/ Scraper		229	Cold Chest Dispenser		220	Dish/Grease Mop		230
Aluminum Strainer		114	Bucket			Cold Meat Fork	83, 88-89, 91		Dishers		
Anti-Jamming Steam Table Pans	100-102, 105		Wine		57, 197	ColorCode System Cutting Boards	148, 177		Ice Cream/Food Specialty		126-128, 41, 128
Apple Divider		138	Ice		57, 197	ColorCode System Knives	152, 154, 177		Dishwasher's Apron		144
Aprons		144	Buffetware			ColorCode System Ladles	123		Dispenser		
Arctic Bar Cloth		57	Goldcrest		89	ColorCode System Tongs	135, 177		Coffee		210
Ashtrays		68	Orbit		83	Comb, Decorating		40	Cold Chest		220
Au Gratin Dish		216	Silvercrest		88	Comb, Decorating		148	Condiment		56, 194
Baby Wooden Chair		225	Bullet Salt & Pepper Shakers		189	Combination Stone		194	Juice		81
Bagger, French Fry		171	Bun & Biscuit Pans		16, 19	Condiment Jar		58	Napkin		198
Bags, Pastry		40	Bun & Biscuit Pan Covers		16	Confectionery/Deep-Fry Thermometer		176	Oil & Vinegar		192-193
Baguette Screens		47	Bun Pan Grates		16	Container, Stainless Steel Heavy-Duty		221	Pancake		37
Bain Marie Pots		107	Butcher Knife		153	Conventional Line Ladles		120	Squeeze		62, 64
Bake & Roast Pans		29	Butcher Steels		153	Conventional Line Serving Spoons		117	Syrup		192, 196
Baker's Dough Scale		173	Butler Tray Stands and Luggage Racks		224-225	Cook's Fork		160	Toothpick		223
Bakeware & Supplies	30-47		Butter Cutter		138	Cook's Knife	152-155, 177		Top Counter		219
Baking Shell		217	Cabinets, Low & High Boy		222	Cooker, Pasta	25, 27		Wrapped Straw		223
Bamboo Basket		202	Caddy, Bar		58	Cookie Cutters		44	Display Pans		46
Bar Caddy		58	Cake, Cover		68	Cookware, Professional	4-29		Divided Pan		106
Bar Cloth, Arctic		57	Cake Pans			Cordiale™, Chafers		90	Divider, Apple		138
Bar Drainer/Mat		54	Layer		39	Cork Puller, Rapid Automatic		50	Docker, Roller		42, 183
Bar Supplies	48-59		Spring Form		39	Cork Removers, Wedge Type		51	Dome Covers		97
Bar Utensils	54-56		Cake Stand		39	Corkscrews	50-51		Domination Pattern Flatware		204
Bar, Adapter		105	Call Bell		223	Corkscrews /Cap Lifters	50-51		Donut Screen		47
Barocco Serving Ware		91	Camp Fork		160	Corn Stick Pan, Cast Iron		167	Double Boilers		
Barrel Salt & Pepper Shakers		189	Can Openers	124-125		Counter Brush		231	Aluminum		13
Baskets			Can Opener-Parts List		124	Cover Holder, Chafer		97	Stainless Steel		25
Aluminum		26	Can Tapper & Bottle Opener		176	Cake		68	Double Boiler Inset		25
Bread & Cracker	202-203		Candy/Deep Fry Thermometer		52	Bun & Biscuit	16, 19		Double Glass Brush		58
Culinary		142	Cap Catcher		53	Dome		97	Double Mesh Skimmer		113
Fast Food	63-64		Cap Lifters/Corkscrews		51	Guest Check		201	Dough Cutters, Multiple Wheel		44
Flatware	57, 220		Cap Remover, Wall		52	Half Long S/S		102	Dough Scrapers		136, 183
Food	62-63		Caps, China		112	Hinged		221	Drain Shelves, Polycarbonate		70
Fry		28	Carafes		211	Lift-Off		221	Dredges		34-35, 185
Inner Metal Wire w/Handle		26	Cart, Dish		225	Menu		201	Dry Measures		33
Taco		142	Carving Knife		88	Polycarbonate Food Pan	70, 102		Duchess Pattern Flatware		207
Tostada		142	Cash & Carry Collection	64, 192		Pot & Pan	13, 18-19		Dutch Oven, Cast Iron		166
Baster		140	Cast Iron Chicken Fryer		166	Roll Top	106, 100		EagleGrip™ Insulating Grips		10
Beater, Egg		141	Cast Iron Corn Stick Pan		167	Storage Container		71	Eagleware		6-17
Bell Creamer		214	Cast Iron Dutch Oven		166	Covers	6, 7, 12, 13, 14, 15, 18, 19, 21-23, 25, 102, 104		Eagleware Professional Aluminum		17, 180
Bell Shaped Pitcher		212	Cast Iron Platters	217-218		Cracker Basket		203	Pizza Trays		125
Bell, Call		223	Cast Iron Round Griddle		167	Cracks, Lobster		199	Easy Turn™ Can Openers		114
Bib Apron		144	Cast Iron Skillets		166	Creamers	82, 212, 214		Economy Colanders		141
Biscuit Pans		16	Cater Trays		216	Cream Servers		211	Egg Beater		165
Block Brushes		228	Chafer Components	96-97		Crumber, Table		199	Egg Mold		165
Boards			Chafer Cover Holder		97	Crushed Fruit & Syrup Jar		222	Egg Rings		165
Cleaning Brushes		149	Chafer Frames		96	Culinary Basket		142	Egg Slicers		137
Cutting	148-151		Chafer Storage Box		97	Cup			Egg Tray		66
Cheese		151	Chafers & Buffetware	76-97		Cup			Exclusive Pattern Flatware		205
Ham		151	Chafers			French Fry		213	Extra Long Handled Utensils		117
Round Lemon		151	Cordiale™		90	Ice Cream	82, 215		False Bottom		105
Boilers, Double	13, 25		Deluxe		90	Jello/Shrimp		215	Fast Food Baskets		63-64
Boning Knives	152-156		Dome Cover	72-73		Malted Milk		57	Faucet, Stock Pots		7
Booster Seats		225	Economy Full Size		95	Sauce		213	Filters, Grease Cone		143
Bottle Opener		52	Full Size	76-77, 80, 84-85, 90, 93, 95		Cups, Measuring Sets		32	Fine Mesh Skimmer		113
Bottle Trough (Speed Rail)		59	Half Size	76-77, 80, 90, 93, 95		Cutlery Boxes	65, 141		Fish & Poultry Shear		165
Bottles, Squeeze		62	Induction		80	Cutter			Fish Spatula		157
Bottom, False		105	Oval		87, 94						

ITEM	SUB INDEX	PAGE	ITEM	SUB INDEX	PAGE	ITEM	SUB INDEX	PAGE	ITEM	SUB INDEX	PAGE
Flask Servers		211	Heavy-Duty Strainer		110-111	Luggage Rack		224	Pullman		47
Flat Bottom Pizza Ladle		120, 183	Heavy-Duty Tongs		135	Machine, Patty Molding		163	Roast		29
Flatware Basket		220	Heavy-Weight Aluminum Roast Pans		29	Magnetic Knife Rack		163	Sauce	10-11, 15, 21, 23	
Flatware Cylinder		59, 220	High Boy Chocolate and Syrup Pumps		222	MalTED Milk Cup		57	Sauté	13, 15, 21, 24	
Flatware Dispensers		57, 219	High Chair		213	Manual			Spillage		106
Flatware			High Heat Scrapper		126	Can Openers		125	Standard		103
Brighton™		206	Hinged Cover		221	Juicers		169	Steam Table		103
Dominion Pattern		204	Hinged Fork/Spoon Salad Set		135	Markers, Plastic Steak		218	Paper, Patty		164
Duchess™		207	Holder			Mashers		133	Parasols, Cocktails		54
Exclusive Pattern		205	Corn		140	Mat, Bar		54	Paring Knives	153, 155-156, 161	
Jewel™		207	Fuel		96	Measures			Parts List, Rapid Cork Puller		50
Pebble™		206	Grill Screen		168	Dry		33	Pasta Cooker		25, 27
Regal™		207	Ham		142	Liquid		33, 72	Pastry Bags		40
Regina Pattern		205	Handle		145	Measuring Cup/Food Portioner		119	Pastry Brushes		42
Swedish Modern Pattern		205	Menu/Card		200	Measuring Cup Sets		32	Pastry Cutters		42
Windsor Pattern		204	Pot		145	Measuring Spoon, Long Handle		33	Pastry Tubes		41
Fluted Melamine Ramekin		193	Snail		198	Measuring Spoon Sets		32-33	Patty Mold Machine Parts List		163
Folding Luggage Rack		224	Sugar Packet		196	Meat Chopper		169	Patty Molding Machine		163
Folding Tray Stand		224	Taco		217	Meat Hook		160	Patty Paper		164
Food Baskets	63-64		Towel		57	Meat Thermometer		174	Pebble Pattern Flatware		206
Food Mill		141	Hollow Ground Steak Knives		161	Medium Density Polyethylene			Peelers		138
Food Pans		96	Hook, Meat		160	Cutting Board		150	Peels, Pizza		182
Food Pans, Polycarbonate		70, 102	Ice Bucket		57, 197	Menu Cover		201	Pepper Mill		193
Food Portioners	118-119, 177		Ice Chipper, Six Point		55	Menu/Card Holder		200	Perforated Serving Spoon	91, 117-118	
Food Preparation		146-177	Ice Core Pitcher		69, 209	Mill			Perforated Steam Table Pans		106
Footed Pan Grates		106	Ice Cream Cup		82, 215	Food		141	Perforated Turner	152, 157-158	
Forged Steel Poultry Shear		165	Ice Cream Dipper		129	Pepper		193	Piano Whip		131-132
Fork			Ice Cream Dishes	41, 126-128		Mini Loaf Pan		46	Picks, Ice		55
Camp		160	Ice Cream Spade		127	Mini Salt & Pepper Shaker		189, 192	Pie Cutter, Stainless Steel		38
Cold Meat	83, 88-89, 91		Ice Cream/Food			Minute Timer		143	Pie Markers		38
Cook's		160	Dishers	41, 126-128		Mitt, Grill/Oven		145	Pie Pin		43
Pot		160	Ice Picks		55	Mixing Bowls	115-116		Pie Server		157, 159
Snail		198	Ice Scoops		131	Mixing Paddles		164, 183	Pin, Pie		43
Frames, Chafer		96	Icing Spatulas	156, 158-159		Mold, Round Egg		165	Pins, Rolling		43
French Fry Bagger		171	Induction Chafers		80	Mop, Dish/Grease		230	Pipes, Overflow		58
French Fry Cup		213	Inner Metal Wire Basket w/ Handle		26	Muddler, Wood		54	Pitchers		55, 212
French Fry Cutter		170	Insets			Muffin Pans		45	Pitchers		
French Fry Cutter Parts List		170	Double Boiler		25	Multiple Wheel Dough Cutters		44	Bell Shaped		212
French Style Steel Fry Pans		27	Triangular Stainless Steel		27	Napkin Dispensers		198	Frothing		57, 212
French Whip	131-132		Vegetable		107	Natural Aluminum Fry Pans		9	Ice Core		69, 209
Frills, Toothpick		54	Insulated Bowls		116	New Era Serving Ware		91	Insulated		209
Frothing Pitcher		57, 212	Insulated Pitchers		209	Non-Stick One-Piece Aluminum			Polycarbonate		69
Fruit Board		151	Insulated Pizza Pouch		183	Ice Cream Dipper		129	Syrup		196
Fruit Knife		161	Insulated Servers		211	Noodle Cutter		171	Water	82, 212	
Fruit or Vegetable Scoop		139	Insulating Grips		10	Noodle Strainer		111	Pizza Cutters		
Fry Basket		28	Janitorial Accessories		231	Nut & Lobster Crack		199	Aluminum Handle		181
Fry Bottoms		28	Janitorial/Brushes	226-231		Nylon Pastry Bags		40	Long Wooden Handle		181
Fry Pans	8-9, 15, 20, 24, 27		Jar			Nylon Utensils		116	Polypropylene Handle		181
Fuel Holder		96	Condiment		184	Offset Spatula		159	Wooden Handle		181
Full Size Chafer	76-77, 80, 84-85, 90, 93, 95		Crushed Fruit & Syrup		222	Offset Icing Spatula		156	Pizza Ladle		113, 173
Full Size Divided Pan		106	Jello/Shrimp Cup		215	Oil & Vinegar Dispenser	192-193		Pizza Pans		17, 180
Full Size Steam Table Pans		100	Jewel Pattern Flatware		207	Oil, Sharpening Stone		162	Pizza Peels		182
Full Size Water Pan		97	Jiggers		56	One-Piece Aluminum Ice Cream Dipper		129	Pizza Pouch		183
Funnels, Plastic		59	Juice Dispensers		81	One-Piece Food Portioners	118-119, 177		Pizza Screens		181
Garlic Presses		139	Juicers		169	One-Piece Scraper		136	Pizza Stand		182
Garnish/Serrator		139	Julep Strainer		55	Opener			Pizza Supplies		178-185
Glass Brushes		58	Jumbo Block Brush		216	Allegacy Giant		52	Pizza Trays		17, 180
Glass Racks		59	Jumbo Steak Knife		161	Bottle		52	Plane, Cheese		88
Glass Rimmer		54	Kitchen Utensils	108-145		Openers, Can	124-125		Plastic Cheese Shakers	184-185, 190-191	
Glass Rimmer Sponge		54	Knife Rack		163	Optima Line Ladles		123	Plastic Corn Holders		140
Gooseneck Teapot		212	Knife Sharpener		162	Optima® Cookware		22-24	Plastic Decanter		210
Grater, Cheese		171	Knives			Optima® III Cookware		18-21	Plastic Dredge		35, 185
Graters		137	Boning	152-156		Optima® II Cookware		22-24	Plastic Funnels		59
Bun Pans	16, 19		Bread	153, 155-156		Order Rack		221	Plastic Handle Ice Cream/Food Dishes		128
Footed Pan		106	Brown ABS Handle		153	Oval Cast Iron Platter		217	Plastic Handle Spoons & Portioners	118-119	
Wire Rib		47	Butcher		153	Oval Chafer		87, 94	Plastic Scoops		130
Gravy Boat	82, 214		Carving		88	Oval Fast Food Baskets		63-64	Plastic Serving Trays		63
Grease Filter Cone Rack		143	Clam		161	Oval Ice Cream Dish		128	Plastic Steak Markers		218
Grease Filter Cones		143	ColorCode System	152, 154, 177		Oval Rattan Underliner		217	Plastic Sugar Pourers		190, 192
Grease Mop		230	Cook's	152-155, 177		Oval Serving Platter		216	Plastic Tong		135
Griddle, Round Cast Iron		167	Fruit		161	Oval Wire Skewer		140	Plastic Toothpick Dispensers		223
Grill Brushes w/Scraper	228-229		Oyster	160-161		Oval Wood Serving Trivet		217	Plastic Tumblers		72
Grill Cleaner Screen		168	Paring	153, 155-156, 161		Oven Brush & Scraper		229	Plasticware		60-73
Grill Scraper	142, 145, 216-217		Santoku		156	Oven Mitts/Aprons	144-145		Plate Scrapers		136
Grill Screen Holder		168	Scimitar		153	Oven Thermometer		175	Plate, Snail		198
Grill/Oven Brush W/Scraper		228-229	Slicer	88-89, 153, 155-156		Overflow Pipes		58	Plates		
Grill/Oven Mitt		145	Steak		161	Oyster Knife	160-161		Pie		38
Gripper, Pan		182	Knock Box, Coffee		102	Pad, Scouring		143	Woven Wood		198
Grips, EagleGrip Insulating		10	Ladles			Paddles, Mixing		164, 183	Platters		216-218
Guest Check Cover		201	Color Coded		123	Pail			Platters		
Half & Full Size Food Pans		96	Conventional Line		120	Opener (Lid-Off)		143	Cast Iron		217-218
Half Long S/S			Deep	83, 88-89		Stainless Steel		213	Stainless Steel w/Underliner		218
Cover		102	Demi Line		120	Utility		164	Steak		217
Pans		102	Flat Bottom Pizza	120, 183		Pan Grates		16, 100	Pocket Test Thermometers		174
Half Size Chafer	76-77, 80, 90, 93, 95		Optima Line		123	Pan Gripper		182	Poly Board-Medium Density		150
Half Size Steam Table Pans		100	Pizza	113, 173		Pancake Dispenser		37	Polycarbonate Basting Spoons		73
Ham Board		151	Polycarbonate	73, 121		Pancake Dispenser Rack		37	Polycarbonate Drain Shelves		70
Ham Holder		142	Renaissance Line		120	Pans			Polycarbonate Food Pans		70, 102
Hamburger Press		164	Serving	83, 88-89, 91		Anti-Jamming	100-102, 105		Polycarbonate Food Pan Covers		70
Hand Cheese Grater		171	Short Handled		123	Bake & Roast		29	Polycarbonate Ladles		73, 121
Hand Protector		145	Soup	107, 121		Bread		46	Polycarbonate Liquid Measures		72
Handle Holder		145	Spout	88-89		Biscuit		16	Polycarbonate Pitchers		69
Handle Sleeve		218	Ultra Line		122	Bun & Biscuit		16, 19	Polycarbonate Salad Spoons		73
Handle			Layer Cake Pans		39	Cake		39	Polycarbonate Sauce Ladles		73, 121
Gold Trim		79	Lemon Board, Round		151	Cast Iron Corn Stick		167	Polycarbonate Scoops		131
Stainless Steel		79	Lemon/Lime Squeezer		55	Cupcake		43	Polycarbonate Serving Utensils		73, 121
Steak Weight		142	Lid-Off		143	Display		46	Polycarbonate Storage Containers		71
Handy Opener		52	Lift-Off Cover		221	Divided		106	Polycarbonate Tongs		73
Hard Rubber Cutting Board		149	Liquid Measures	33, 72		Food		90	Polyethylene Cutting Board		148-150
Hat, Chef's		144	Lobster Cracks		199	Fry	8-9, 15, 20, 24, 27		Polypropylene Basket		203
Heating Plates, Savoir		79, 81	Locking Tongs		134	Full Size Divided		106	Portion Control Scales		172-173
Heavy-Duty Aluminum Braziers		12	Long Handle Measuring Spoon		33	Full Size Water		91	Portioners, Food	118-119, 177	
Heavy-Duty Aluminum Colander		114	Long Handle Whip		132	Mini Loaf		46	Pot Brush		230
Heavy-Duty Aluminum Roast Pan		29	Long Wooden Handle Pizza Cutter		181	Muffin		45	Pot Fork		160
Heavy-Duty Aluminum Stock Pots		27	Long-Ring Minute Timer		143	Perforated Steam Table		106	Pot Holder		145
Heavy-Duty Mixing Bowl		115	Low and High Boy Cabinets		222	Pie		38	Potato Ricer		141
Heavy-Duty Portion/Receiving Scale		173	Low Boy Chocolate and Syrup Pumps		222	Pizza		17, 180	Potato Wedge Cutter		170
			Lug, Stacking		65	Polycarbonate Food		70, 102			

ITEM	SUB INDEX	PAGE	ITEM	SUB INDEX	PAGE	ITEM	SUB INDEX	PAGE	ITEM	SUB INDEX	PAGE
Pots			Grill Cleaner		168	Squeezer			Refrigerator/Freezer		175-176
Air		210-211	Splatter		110	Citrus		55	Timers		143
Bain Marie		107	Seamless Rim Aluminum Pizza Screen		181	Lemon/Lime/Orange		55	Tomato Corer		139
Coffee		212	Sectional Cutting Board		151	Stacking Lug		65	Tomato Slicer		168
Sauce		7, 14	Serrator/Garnish Server		139	Stacking Teapot/Creamer		214	Tomato Slicer Blade Only		168
Stock		6, 14, 18, 22, 25, 27	Coffee		81, 211	Stainless Steel Bar Spoon		56	Tongs		134-135, 177
Stock w/Faucets		7	Cream		211	Stainless Steel Cookware		22-24	Toothpick Dispenser		223
Pouch, Pizza		183	Flask		211	Stainless Steel Cutlery Box		141	Toothpick Frills		54
Poultry Shear		165	Insulated		211	Stainless Steel Double Boilers		25	Top Counter Dispensers		219
Pourers			Pastry		88-89	Stainless Steel Double Jiggers		56	Top Shelf™ Chafer		92-95
Pint		53	Pie		157, 159	Stainless Steel Dredges		34, 185	Tortilla Warmer		218
Quart		53	Revolving Relish Stationary		194	Stainless Steel Flour Sifter		37	Tostada Basket		142
Sugar		190, 192	Serving Fork		83, 88-89, 91, 117	Stainless Steel Footed Colander		114	Tote Boxes		65
Press			Serving Ladle		83, 88-89, 91	Stainless Steel French Wire Whip		131-132	Towel Holder		57
Garlic		139	Serving Spoons			Stainless Steel Fry Pan with Two Handles		24	Tower Salt & Pepper Shaker		189, 192
Hamburger		164	Conventional Line		117	Stainless Steel Heavy-Duty Container		221	Tray Stands		224-225
Professional Aluminum Braziers		12	Notched		83, 88-89	Stainless Steel Ice Cream Dish		127	Trays		
Professional Aluminum Double Boilers		13	Perforated		91, 117-118	Stainless Steel Mixing Bowl		115	1 LB. Boat/Food		66
Professional Aluminum Fry Pans		8-9, 15, 20	Renaissance Line		117	Stainless Steel Mixing Paddle		164, 183	6 Compartment Mess		141
Professional Aluminum Non-Stick			Slotted		83, 88-89, 117-118	Stainless Steel Pails		213	All-Purpose Prep		67
Sauce Pans		11	Solid		83, 88-89, 91, 117-118	Stainless Steel Piano Wire Whip		122	Cater		216
Professional Aluminum			Serving Trays		68, 216	Stainless Steel Pie Cutter		38	Egg		66
Sauté Pans		10, 15, 21	Serving Ware			Stainless Steel Platter w/Underliner		218	Pizza		17, 170
Professional Aluminum Stock Pots		13, 15, 21	Barocco		91	Stainless Steel Potato Ricer		141	Plastic Serving		62
With Baskets		26	New Era		91	Stainless Steel Rim Sieves		35	Prep		67
Professional Cookware		4-29	Shaker, Cocktail		56	Stainless Steel Round Platter		216	Serving		68, 216
Professional Corkscrew & Cap Lifter		51	Shakers			Stainless Steel Scoops		36, 130	Woven Wood		198
Professional Waiter's Corkscrew & Cap Lifter		51	Cheese		184-185, 190-192	Stainless Steel Seafood Shell		218	Triangular Stainless Steel Insets		27
Protector, Hand		145	Salt & Pepper		188-189, 192	Stainless Steel Sponges		143	Triple Glass Brush		58
Pullman Pans		47	Sharpener, Knife		162	Stainless Steel Spring Tongs		134	Triple Oilstone Replacement		163
Pumps			Sharpening Stone		162	Stainless Steel Teapot/Creamer		214	Triple Stone (Sharpening Stone)		163
High Boy Chocolate & Syrup		222	Sharpening Stone Oil		162	Stainless Steel Tong		134-135, 177	Trivet, Oval Wood Serving		217
Low Boy Chocolate & Syrup		222	Sharpening Stone with Handle		162	Stainless Steel Turner		158-159	Trough, Bottle		57
Rack			Shears, Poultry		165	Stainless Steel Wire Skewer		140	Tubes, Pastry		41
Cutting Board Storage		149	Shell			Stand			Tulip Sundae Dish		203
Glass		59	Baking		217	Cake		39	Tumblers, Plastic		72
Grease Filter Cone		143	Stainless Steel Seafood		218	Pizza		182	Turner		
Knife		163	Sherbet/Sundae Dish		215	Standard Pans		97-98	Perforated		152, 157-158
Luggage		224	Short Handled Ladles		123	Standard Waiter's Corkscrew & Cap Lifter		51	Specialty		158
Pancake Dispenser		37	Shrimp Master		165	Standard Weight Aluminum Braziers		12	Square		158
Wire		194-195	Sieves			Stands, Tray		224-225	Stainless Steel		158-159
Ramekin, Fluted Melamine		193	Stainless Steel Rim		35	Stationary Server		194	Ultra Line Ladles		122
Rapid Automatic Cork Puller		50	Wooden Rim		35	Steak Knives		161	Undercounter Dish 'N Tote Box		65
Rapid Cork Puller Parts List		50	Sifter, Stainless Steel Flour		37	Steak Platter		217	Underliner		
Rattan Underliner, Oval		217	Single Egg Slicer		137	Steak Tenderizer		140	Oval Rattan		217
Refill Glass Brush		58	Six in One™ Chafer		92	Steak Weight		142	Wooden		217
Refrigerator/Freezer Thermometer		175-176	Six Point Ice Chipper		53	Steak Weight Handle		142	Urn Gauge Brush		230
Regal Pattern Flatware		207	Skewer, Wire		140	Steam Table Pans		100-106	Utensils		
Regina Pattern Flatware		205	Skillets, Cast Iron		166	Steam Table Pans & Insets;			Bar		54-56
Remover, Wall Cap		52	Skimmers		113	Bain Maries		98-107	Extra Long Handled		117
Renaissance Line Ladles		120	Sleeve, Handle		218	Steamer, Clam		167	Nylon		116
Renaissance Line Serving Spoons		117	Slicer Knife		88-89, 153, 155-156	Steel Blades		159	Small		136-142
Revolving Relish Server		194	Cheese		138	Steel Fry Bottom		28	Utility Brushes		230-231
Ricer, Potato		141	Egg		137	Steel Fry Pans		27	Utility Pail		164
Rimmer, Glass		54	Tomato		168	Steel Poultry Shears		165	Utility Spatula		157-158
Rings, Egg		165	Slotted Serving Spoon		83, 88-89, 117-118	Steels, Butcher		143	Vegetable Insets		107
Roast Pans		29	Small Cheese Board		151	Stock Pot, Lid & Aluminum Basket		26	Vegetable Scoop		139
Roller Docker		42, 183	Snail (Escargot) Plate		198	Stock Pots		6-7, 14, 18, 22, 25, 27	Wall Cap Remover		52
Rolling Pins		43	Snail Fork		199	Stock Pots & Sauce Pots		6-7, 14, 18-19	Warmer, Tortilla		218
Rolltop Chafers		84-87	Snail Holder		198	Stock Pots w/Baskets		26	Water Pan, Full Size		79, 97
Rolltop Cover		91, 100	Solid Serving Spoon		83, 88-89, 91, 117-118	Stock Pots w/Faucets		7	Water Pitcher		82, 212
Rotary Egg Beater		141	Sonata Serenade™, Chafers		84-87	Stone, Sharpening		162	Wedge Cutter Parts		170
Round Bowl Spoon		91	Soup Ladle		107, 121	Storage Box, Chafer		97	Wedge-Type Cork Remover		51
Round Chafing Dish		78, 80, 84, 86-87, 90, 94	Soup Station		94	Storage Containers, Polycarbonate		71	Wedge, Aluminum Egg		137
Round Cookie Cutter Sets		44	Spade, Ice Cream		127	Storage Container Covers		71	Weight, Steak		142
Round Egg Mold		165	Spaghetti Tong		134	Storage Racks, Cutting Board		149	Weights		173
Round Lemon Board		151	Spatula			Strainers			Whip, Wire		131-132
Round Pastry Brush		42	ColorCode System		152	Bouillon		112	Whips		131-132
Round Wire Skewer		140	Fish		157	Cocktail		55	White Polyethylene Cutting Board		149
Rubber Scrap Block		143	Icing		156, 158-159	Double Mesh		110-111	Wide Mouth Squeeze Bottles		62, 64
Salad & Chopping Bowls		208	Offset		159	Heavy Duty		110-111	Willow Baskets		202
Salad Fork & Spoon Set		208	Offset Icing		156	Julep		55	Windsor Pattern Flatware		204
Salad Spoons, Polycarbonate		73	Utility		157-158	Noodle		111	Wine Buckets		57, 197
Salt & Pepper Shakers		188-189, 192	Speed Rail		59	Single Mesh		110-111	Wire Basket w/Handle		26
Sandwich Spreader		156, 159	Speed Rail Strap		59	Stainless Steel		111	Wire Fry Baskets		28
Santoku Knife		156	Spillage Pan		106	Straw Dispensers		223	Wire Racks		194-195
Sauce Cup		213	Splatter Screen		110	Sugar Bowl		82	Wire Rectangular Fry Basket		28
Sauce Ladles, Polycarbonate		73, 121	Sponge, Glass Rimmer		54	Sugar Packet Holder		196	Wire Rib Grate		47
Sauce Pans		10-11, 15, 21, 23	Sponges, Stainless Steel		143	Sugar Pourers		190, 192	Wire Sugar Pack Holder		196
Sauce Pots		7, 14, 19	Spoon			Sunkist Electric Juicer		169	Wire Tap Brush w/Scrap		229
Sauté Pans		13, 15, 21, 24	Notched Serving		83, 88-89	Super-Heavy Professional			Wood Muddler		54
Savoit™ Chafers		76-80	Oval Basting		91	Corkscrew & Cap Lifter		51	Wood Serving Trivet, Oval		217
Scales			Perforated Serving		91, 117-118	Supreme Bowl		215	Wooden Baby Chair		225
Baker's Dough		173	Round Bowl		91	Swedish Modern Pattern Flatware		205	Wooden Mixing Paddle		164
Portion Control		172-173	Slotted Serving		83, 88-89, 117-118	Syringe Set		41	Wooden Pizza Peels		182
Scimitar Knife		153	Solid Serving		83, 88-89, 91, 117-118	Syrup Dispensers		192, 196	Wooden Rim Sieves		35
Scissor Tong		135	Square Bowl		91	Syrup Pitcher		196	Wooden Spoons		133
Scoops			Stainless Steel Bar		56	Table Crumber		199	Wooden Tray Stands		225
Aluminum		36-37, 130-131	Spoons & Portioners		118-119	Tabletop & Service		186-225	Wooden Underliner		217
Fruit or Vegetable		139	Spoons/Ladles		117-123	Taco Basket		142	Woven Wood Plates		208
Ice		131	Spoon Shape Scrappers		126	Taco Holder		217	Woven Wood Salad Bowls		208
Plastic		130	Spoons Wooden		133	Tall Menu & Card Holder		200	Woven Wood Trays		208
Polycarbonate		131	Spoons			Teapot, Gooseneck		212, 214	Wrapped Straw Dispenser		223
Stainless Steel		36, 130	Measuring Sets		32-33	Teapots/Creamers		212, 214			
Scouring Pad		143	Serving		118	Teflon Fry Pans		8-9, 24			
Scrap Block, Rubber		143	Spout Ladle		88-89	Teflon Platinum Pro Fry Pans		9			
Scraper			Spreader, Sandwich		157, 159	Teflon Xtra Fry Pans		8, 24			
Bowl		136	Spring Form Cake Pans		39	Tenderizer, Steak		140			
Dough		136, 183	Spring Tong		134	The Point-Two-Five-Line					
Grill		142, 145	Square Bowl Spoon		91	Heavy-Duty Cookware		14-15			
Scrapers, Plate		136	Square Graters		137	Thermometer					
Screens			Square Turner		158	Candy/Deep Fry		176			
Aluminum Pizza		181	Squeeze Bottles		62, 64	Confectionery/Deep Fryn		176			
Baguette		47	Squeeze Dispensers		62, 64	Dial Meat		174			
Donut		47				Digital		175			
						Meat		174			
						Oven		175			
						Pocket Test		174			

NUMERICAL INDEX

ITEM	PAGE	ITEM	PAGE	ITEM	PAGE	ITEM	PAGE	ITEM	PAGE	ITEM	PAGE	ITEM	PAGE	ITEM	PAGE
010CP	39	115M	54	150512	158	2089	105	2155SPL60	23	2690	215	3608	208	4909	208
011	39	1155L	88	15056	158	208WR	112	2155SPL8	23	27	167	3610	208	4910	208
0113	135	1155LGD	89	15058	158	208WRE	112	2155SPL80100	23	2712	120	3612	208	4911	208
013010	208	117PS	88	1506	205	2090	97	2155STP3	24	2716	120	3614	208	4912	208
0136	39	117PSGD	89	1507	205	20P	112	2155STP5	24	2724	120	3616	208	4913	208
0404	120	11824	151	15085F	205	20PE	112	2155STP7	24	2732	120	3618	208	4917W	42
0405	120	11830	151	1505P	188	210PE	112	220	83	273912	120	3620	208	4919W	42
08	39	118PS	88	15105S	205	210WRE	112	22002	100	2741	120	368	59	493FB	67
09	39	118PSGD	89	1511B	56	2100	82, 215	22002P	105	274112	120	369	59	493FG	67
100012	36, 130	119	88	15173	130	2101	62	22004	100	2742	120	370	59	493FR	67
100012E	36	1190MC	32	1515P	188	2101-12	62	22004P	105	2743	120	3712	120	493FT	67
100016	36, 130	1191MC	32	1522	140	2102	62	22006	100	2744	120	3739	120	493FW	67
100016E	36	1191MC13	32	1525P	188	2102-12	62	22006P	105	2746	120	3740	120	493FY	67
100020	36, 130	1191MC14	32	1535P	188	2103	62	220304	161	2748	120	3741	120	495FB	66
100020E	36	11975	52	1545P	188	2103-12	62	220605	161	2750	117	374112	120	495FG	66
100023	36, 130	1199	52	1550	225	2108	82, 214	2206FL	196	2752	117	3742	120	495FR	66
100023E	36	1199GD	89	1551	225	211	83	2206PL	196	2754	117	3743	120	495FT	66
100026	36, 130	120	88	1555P	189	2110	82, 214	2208	203	2760	117	3744	120	495FW	66
100026E	36	1209CB	208	1565P	188	2116	82, 214	220GD	83	2762	117	3746	120	495FY	66
100030	36, 130	120GD	89	1575P	189	211GD	83	221	198	2764	117	3748	120	496FB	63
100030E	36	120PM	193	1586	224	212	83	22121	208	2770	117	374HD	113	496FG	63
1009	134	1213	165	1586E	224	2122	103	22122	208	2772	117	374SK	113	496FO	63
100B	229	1214	165	158GD	189	2124	103	22122P	105	2774	117	375	113	496FR	63
1012	134	12151	171	1585	189	2126	103	22122STP	100	283104	161	3750	117	496FT	63
1013	134	1216B	63	1600W	206	212GD	83	22123	208	286	57	3752	117	496FW	63
1014B	63	1216R	63	1601W	62	213	83	22124	208	289	141	3754	117	496FY	63
1014R	63	1216SS	141	1602	206	2132	103	22124P	105	2900	204	375HD	113	497FBC	66
101B	201	1217	165	1602W	62	2134	103	22124STP	100	2902	204	3760	117	497FGC	66
101R	201	1219	165	1603	206	2136	103	22126	100	2903	204	3762	117	497FRC	66
103B	201	121PF	88	1603W	62	213GD	83	22126P	105	2904	204	3764	117	497FTC	66
103R	201	121PFGD	89	1604	206	214	83	2212FL	196	2906	204	376HD	113	497FWC	66
1043	215	122	88	1606	206	2142	103	2212PL	196	2907	204	3770	117	497FYC	66
1045	215	1220	165	1606A	114	2144	103	22132	101	2908SF	204	3772	117	498FB	67
105237	216	1223	40	1606H	114	2146	103	22134	101	2909	204	3774	117	498FG	67
105241	216	1223C	40	1607	206	214GD	83	22136	101	291	138	3804	165	498FR	67
105246	216	1226	139	1607A	114	2162	103	22142	101	292	55	3805	165	498FT	67
105254	216	1226PH	139	1608	206	2164	103	22144	101	298	231	3806	165	498FW	67
1060	215	122GD	89	1610	206	2166	103	22146	101	2981	216	3825	165	498FY	67
107	201	123	131	1612A	45	218	83	2214FL	196	2982GD	216	386	138	499FAST	63
10RS	140	124	88	1618	133	218GD	83	22162	102	2983	216	386W	138	499FB	63
10SO	140	1250	37	1623	133	219P	158	22164	102	2984	216	3915W	42	499FG	63
1100	62	126	88	1624A	45	219PEH	158	22166	102	2985	216	3916W	42	499FO	63
1100-12	62	1260	37	1700W	207	2155BR15	23	22192	102	2986	216	3917W	42	499FR	63
1101	62	1265	136	1702	207	2155BR20	23	22194	102	29924	230	3919W	42	499FT	63
1101-12	62	1266	136	1703	207	2155BR25	23	2215	198	2WT	173	3920W	42	499FW	63
1102	62	126GD	89	1704	207	2155BR30	23	2220	140	3010	199	3921W	42	499FY	63
1102-12	62	1287	55	1706	207	2155DB12	25	22232	101	3012	198	3922W	42	4W	173
1103GB	214	128CP	88	1707	207	2155DB16	25	22234	101	305	161	3925W	42	5000	161
1105	214	129	88	1708	207	2155DB20	25	22236	101	306	198	3K	138	5005	161
1108	214	1290	56	1710	207	2155DB8	25	22241L	102	305P	189	3RS	141	50112SS	141
111	88	1291	56	1718	133	2155DBC12	25	22242L	102	3100EP	168	4065	223	5015S	141
111GD	89	1292	56	1725	133	2155DBC16	25	22244L	102	310R	43	410	228	5020	161
112	88	1293	56	1726	133	2155DBC20	25	22246L	102	313R	43	4107	200	5020T	41
1121	162	1294	56	177	196	2155DBC8	25	2225	44	313RTWN	43	4115	200	5021T	41
11218	151	1295	56	1777WP	139	2155DB112	25	2226	44	315R	43	4125	200	5022T	41
1122F	163	12RS	140	1800W	207	2155DB120	25	2227DC	44	315RTWN	43	4134	51	5023T	41
1123M	163	1250	140	1801	207	2155DBP12	25	2225	160	31813	16	4136	51	5024T	41
1124C	163	130	88	1802	207	2155DBP20	25	2234BB	202	31813C	16	4137	51	5025T	41
112GD	89	1305	113	1803	207	2155FP11	24	2254	202	31813E	19	4145	200	5026T	41
113NS5	88	1305T	113	1804	207	2155FP12	24	230	137	31813P	16	4155	200	5027T	41
113NS5GD	89	1306	113	1806	207	2155FP14	24	231	198	31813PE	19	4165	200	5028T	41
1140	194	1306T	113	1807	207	2155FP211	24	2314	32	318R	43	41814	16	5029T	41
1140B	194	1307	113	1808	207	2155FP213	24	2315	33	318RTWN	43	41814E	19	5030PH	160
1140R	194	1307T	113	1810	207	2155FP29	24	2316	32	3199	37	41814P	16	5040T	41
1141	51	1308MS	113	182DS	136, 183	2155FP8	24	2316EH	32	315H	198	420	202	5041T	41
1144	50	1308T	113	182PH	136, 183	2155FP9	24	2318	32	3201	62	4203	229	5042T	41
1144-17	50	1309	113	183	136, 183	2155FP11	24	2315	198	3201W	62	424BB	228	5043T	41
1144-18	50	1309T	113	188	196	2155FP12	24	2320-1	33	3202	62	424PK	161	5044T	41
1144-19	50	1310	43	1900	65	2155FP14	24	2320-2	33	3202W	62	44	158	5045T	41
1144-20	50	1312T	113	1919	65	2155FP8	24	2320-3	33	3203	62	4441	160	5046T	41
1144-21	50	1313	43	1929	143	2155FP9	24	2320-3	33	3203W	62	4450HP	164	5047T	41
1144-22	50	1315	43	193R	194	2155PC12	25	233HT	158	322ITB	68	4459	202	5048T	41
1144-22a	50	1318	43	1943	57	2155PC16	25	23501	182	322ITR	68	4497	202	5049T	41
1144-23	50	13200	142	1990	65	2155PC20	25	23506	182	3300	168	45	44	50982	210
1144-24	50	1400W	207	19924	164, 183	2155PC8	25	23511	182	3300W	205	4511	134	50982D	210
1144-25	50	1402	207	19930	164, 183	2155SP1	23	23516	182	3302	205	4512	134	51140	216
1144-26	50	1403	207	19936	164, 183	2155SP10	23	2401	62	3303	205	4513	134	51143	216
1144-27	50	1404	207	19942	164, 183	2155SP100	22	2401W	62	3304	205	453	55	51146	218
1144-28	50	1406	207	19948	164, 183	2155SP12	22	2402	62	3306	205	4600	54	5116	182
1144-29	50	1407	207	19954	164, 183	2155SP16	22	2402W	62	3307	205	46CC	44	5117	182
1144-30	50	1408	207	19960	164, 183	2155SP2	23	2403	62	3308	205	4750	117	5158	231
1144-31	50	1410	207	1W	173	2155SP20	22	2403W	62	3310	205	4752	117	5216	182
1144-32	50	14101	65	2001	181	2155SP24	22	2428	143	3400	143	4754	117	5217	182
1144-35	50	1418B	63	2002STP	103	2155SP3	23	246	130	3450HP	164	4760	117	526C	199
1147K	51	1418R	63	2003	181	2155SP32	22	248	131						

ITEM	PAGE	ITEM	PAGE	ITEM	PAGE	ITEM	PAGE	ITEM	PAGE	ITEM	PAGE	ITEM	PAGE	ITEM	PAGE
53702	173	5724P	118	6722	119, 177	775P	189	82024	129	8844GY	123	9948L	107, 121	AL0105P	124
53703	173	5728	118	6722P	119, 177	79201	28	8202G	212	8844SH	123	9954	164	AL0110W	124
53704	173	5728P	118	6723	119, 177	79204	28	8203	212	8845SHSS	123	996	181	AL010WS	124
53705	173	5742	118	6723P	119, 177	79207	28	82030	129	8846	123	9960	164	AL020	124
53706	173	5742P	118	6724	119, 177	79210	28	8203G	212	8846SHSS	123	996LH	181	AL020A	124
53707	173	5742PG	118	6724P	119, 177	79213	28	821CH	162	8846TL	123	997	113	AL020B	124
53708	173	5743	118	6726	119, 177	79216	28	822	91	8848	123	A1	170	AL020BP	124
53709	173	5743P	118	6726P	119, 177	79300	58	8232	103	8848SHSS	123	A10	17, 180	AL020G	124
548	200	5744	118	6728	119, 177	79302	58	8234	103	8848OR	123	A10P	170	AL020H	124
5480	29	5744P	118	6728P	119, 177	79303	58	8236	103	8859	203	A11	17, 180	AL020K	124
55002	100	5746	118	678	143	79305	58	829W	143	8869	203	A1109B	38	AL020KH	124
55002P	105	5746P	118	678C	143	79501	57, 197	8310	133	8879	203	A1110B	38	AL020KHP	124
55004	100	5748	118	69	201	79502	57, 197	8310EH	133	8889	203	A11P	170	AL020LB	124
55004P	105	5748P	118	691	151	7958	215	8310HD	133	8899	203	A12	17, 180	AL020NB	124
55006	100	5750	118	6950	57, 197	795C	215	8312	133	89052	143	A12183	29	AL020S	124
55006P	105	5752	118	69501	57, 197	79731	142	8312EH	133	89054	143	A12P	170	AL020SB	124
5500W	204	5754	118	69502	57, 197	79734	142	8312HD	133	89501	57, 197	A13	17, 180	AL020SP	124
5502	204	5760	118	698	201	79737	142	8314	133	8J	169	A133	137	AL020W	124
5503	204	5761	118	69R	201	79741	142	8314EH	133	8J230-50	169	A134	138	AL1000A	80
5504	204	5762	118	705	142	79744	142	8314HD	133	8J230-60	169	A13L	170	AL1001A	80
5505	204	5763	118	706	142	79747	142	8316	133	8R5	140	A14	17, 180	AL1002A	80
5506	204	5764	118	707	142	79751	142	8316EH	133	850	140	A14203	29	AL100A	85
5507	204	5770	118	707H	142	79754	142	8316HD	133	903	230	A14B	170	AL101A	85
5508	204	5772	118	708	142	79757	142	8318	133	907	231	A15	17, 180	AL1100	81
5509	204	5774	118	70843	116	79901	201	8318EH	133	909	231	A15C	170	AL1110	81
5510	204	57S	190	70846	116	79921	201	8405	38	9091	110	A15F	170	AL1120	81
5511BK	135	575P	190	709	142	79941	201	8406	38	9092	110	A15S	170	AL1130	81
5511BL	135	5814S	151	70MCL	201	71P	55	8407	38	9093	110	A16	17, 180	AL1140	81
5511GR	135	5821	162	70MCLB	201	8001	105	8408	38	9094	110	A16C	170	AL1150	82
5511PL	135, 177	589BG	203	70MCLR	201	8002	96, 103	8409	38	9095	110	A16F	170	AL1160	82
5511RD	135	5900	204	712B	201	8002DV	106	840PSR	130	9096	110	A16S	170	AL1170	82
5511TN	135	59001	216	712BL	201	8002P	106	840PSW	130	9098	110	A17	17, 180	AL1180	82
5511WH	135	59004	216	712R	201	8004	96, 103	8410	38	9099	110	A17T	170	AL12496FB	64
5511YL	135	59007	216	715	223	800412WD	97	8412	38	9100	110	A18203	29	AL12496FG	64
5512BK	135	59010	216	71771	136	8004P	106	841HG	161	9150	110	A2	170	AL12496FO	64
5512BL	135	59013	216	71774	136	8006	103	8424EH	133	91771	136	A250	170	AL12496FR	64
5512GR	135	59016	216	71777	136	8006P	106	8428EH	133	91774	136	A3	170	AL12496FT	64
5512PL	135, 177	59019	216	725	223	800CS	184, 190	844713	43	91777	136	A375	170	AL12496FW	64
5512RD	135	59022	216	72667	171	800CSP	184, 190	844715	43	9193	110	A4	170	AL12496FY	64
5512TN	135	59025	216	72919	122	800HR	162	844718	43	9194	110	A5	170	AL12499FB	64
5512WH	135	59028	216	72932	122	800KS	162	8511	134	9195	110	A500	170	AL12499FG	64
5512YL	135	59031	216	741HG	161	800RS	162	8512	134	9196	110	A5HP	164	AL12499FO	64
55122	100	59034	216	742HG	161	80104	59, 220	8513	134	9198	110	A6	170	AL12499FR	64
55122P	105	59037	216	74840	172	801X	184, 191	856	38	9199	110	A7C	170	AL12499FT	64
55124	100	59040	216	74843	172	801XG	184, 191	857	38	9200	110	A8	17, 180	AL12499FW	64
55124P	105	599	203	74846	172	802DZ	184, 191	858	38	923P	139	A8L	170	AL12499FY	64
55126	100	5KP	138	74849	172	802X	184, 191	86100E	19	92409WH	125	A9	17, 180	AL12610	126
55126P	105	600G	193	74852	172	802XG	185, 191	86113	120, 183	92410RD	125	A9P	170	AL12612	126
5513BK	135	600PT	193	74855	172	802XGDZ	185, 191	88	51	92411BLK	125	AB12	26	AL12616	126
5513BL	135	600R	193	74858	172	802XPL	184, 191	88002	100	92412WH	125	AB16	26	AL12620	126
5513GR	135	600S	193	74861	172	802XPL	184	88002P	105	92413RD	125	AB20	26	AL12624	126
5513PL	135, 177	600STP	193	74864	172	803DZ	185, 191	88004	100	92414BLK	125	AB24	26	AL12630	126
5513RD	135	60IC	55	74867	172	803X	185, 191	88004P	105	92415RD	125	AB32	26	AL12640	126
5513TN	135	61	217	74870	172	8095	110	88006	100	92416BLK	125	AB40	26	AL1266	126
5513WH	135	6100	165	74873	172	80953	225	88006P	105	92417WH	125	AB60	26	AL1268	126
5513YL	135	61116	120, 183	74879	172	80956	225	8812	123	92418RD	125	AB80	26	AL1280	158
55132	101	6121N	58	74882	172	80973	225	88122	100	92419BLK	125	ABR15	21	AL12810	126
55134	101	6121NE	58	74885	172	80976	225	88122P	105	9250	110	ABR18	21	AL12812	126
55136	101	6121NE1	58	7511	134	8098	110	88124	100	927	229	ABR24	21	AL12816	126
55142	101	6131N	58	7512	134	8099	110	88124P	105	947CC	44	AD3571	34, 185	AL12820	126
55144	101	6141N	58	7513	134	8121	105	88126	100	947EB	141	AD91	58	AL12824	126
55146	101	61622-40E	19	75858	169	8122P	106	88126P	105	9511	134	ADH3571	34, 185	AL12830	126
55162	102	61771	136	75861	169	81225TP	96, 103	88128RD	123	9512	134	AFP18	20	AL12840	126
55164	102	61774	136	75870	168	8124	96, 103	88132	101	9513	134	AFP20	20	AL1286	126
55166	102	61777	136	75870B	168	8124P	106	88134	101	963	163	AFP25	20	AL1288	126
55192	102	61826-32	16	77002	100	8126	103	88136	101	9810	35	AFP30	20	AL1290	158
55194	102	61826-36	16	77002P	105	8126P	106	88142	101	9812	35	AFP35	20	AL1290EH	158
55232	101	61826-36E	19	77004	100	812BS	91	88144	101	9814	35	AFP18G	20	AL12SD	129
55234	101	61826-40	16	77004P	105	813	91	88146	101	9816	35	AFP20G	20	AL13010	127
55236	101	61826-40E	19	77006	100	8132	103	8816	123	9818RS	35	AFP25G	20	AL13012	127
5524	199	61826-40PE	19	77006P	105	8134	103	88162	102	986	230	AFP30G	20	AL13016	127
5551	160	61826-40P	16	77142	101	8136	103	88164	102	9900W	206	AFP35G	20	AL13020	127
556	41	61826-51	16	77144	101	814	151	88166	102	9902	206	AFPE18G	20	AL13024	127
557	41	61826C	16	77146	101	8142	103	88192	102	9903	206	AFPE20G	20	AL13030	127
555	190	62WU	217	77162	102	8144	103	88194	102	9904	206	AFPE25G	20	AL13040	127
555P	190	63	217	77164	102	8146	103	882	41	9906	206	AFPE30G	20	AL1306	127
56	158	6500	213	77166	102	8145	151	88232	101	9907	206	AFPE35G	20	AL1308	127
5602	204	650012	213	77192	102	815	91	88234	101	9908	206	AFPQ18	20	AL16SD	129
5603	204	650012H	213	77194	102	816	91	88236	101	9910	206	AFPQ20	20	AL172C	218
5604	204	650012R	213	7712	122	8162	103	883	41	9911	206	AFPQ25	20	AL200A	85
5605	204	65004	213	77122STP	100	8164	103	8839	123	9912	206	AFPQ30	20	AL200GA	85
5606	204	65004H	213	77124P	105	8166	103	8839GR	123	9912BLK	122	AFPQ35	20	AL201A	86
5607	204	65004R	213	77124STP	100	817	91	8839SH	123	9913	206	AH6	145, 218	AL201GA	86
5608	204	6500H	21												

ITEM	PAGE	ITEM	PAGE	ITEM	PAGE	ITEM	PAGE	ITEM	PAGE	ITEM	PAGE	ITEM	PAGE	ITEM	PAGE
AL320A	92	ALST16	129	BG78R	217	CP8142	104	EW2510WC	14	EWSB16	26	HDA20175	29	MW40	132
AL320GA	92	ALST20	129	BG78U	217	CP8142NC	104	EW2512	14	EWSB20	26	HDA20177	29	N127	140
AL324A	92	ALST24	129	BIA1	144	CP8162	104	EW2512WC	14	EWSB24	26	HDA20178	29	N130	140
AL324GA	92	ALST30	129	BIA2B	144	CP8162NC	104	EW2514	14	EWSB32	26	HDA201735	29	N186	135
AL326A	92	ALST40	129	BIA3GR	144	CP8192	104	EW2514WC	14	EWSB40	26	HDA20175	29	N200	220
AL326GA	92	ALTD5	223	BIA6BR	144	CP8192NC	104	EW2520	14	EWSB60	26	HDA20177	29	NPB1	40
AL329A	92	ALTD5PL	223	BIA7R	144	CP8232	104	EW2520WC	14	EWSB80	26	HDA12225	41, 128	NPB10	40
AL329GA	92	ALW6	170	BMP1	107	CP8232NC	104	EW2532	14	F16	27	HM45	163	NPB2	40
AL346A	92	ALW6C	170	BMP12	107	CS25	55	EW2532WC	14	F18	27	HM69	163	NPB3	40
AL346GA	92	ALW6P	170	BMP2	107	CS277WC	56	EW2540	14	F20	27	HP11	145	NPB4	40
AL349A	92	ALW8	170	BMP3	107	CS30	55	EW2540WC	14	F28	27	HP1T	145	NPB5	40
AL349GA	92	ALW8C	170	BMP4	107	CS35	55	EW2560	14	F32	27	HP11	17, 180	NPB6	40
AL390A	92	ALW8P	170	BMP6	107	CS377	56	EW2560WC	14	F36	27	HP11	17, 180	NPB7	40
AL390GA	92	AP100	18	BMP8	107	CS377WC	56	EW32	6	F40	27	HP11	17, 180	NPB8	40
AL400A	87	AP100WC	27	BS65S	220	CS40	211	EW32WC	6	FB810	105	HP11	17, 180	NPB9	40
AL400RTA	84	AP12	18	C801	52	CS53812	56	EW40	6	FB917	105	IB22	57, 197	NS56	111
AL401A	87	AP120WC	27	C801DZ	52	CS64	211	EW40F	7	FC1000	57, 212	IMB1	116	ODU12130	128
AL402A	87	AP140WC	27	CA1611	114	CS64BT	211	EW40FWC	7	FC150	57, 212	IMB2	116	ONST2227BLK	68
AL420A	93	AP16	18	CA1611E	114	CS8251512B	97	EW40WC	6	FC2000	57, 212	IMB3	116	ONST2227BR	68
AL420GA	93	AP160WC	27	CA1616	114	CS8251512G	97	EW60	6	FC23	54	IP4022B20B	209	OP75	58
AL422A	93	AP20	18	CA1616E	114	CT1	212	EW60F	7	FC25	54	IP4022B20P	209	OP80	58
AL422GA	93	AP200	210	CBB1R	149	CT84004	176	EW60FWC	7	FC350	57, 212	IP4022B40B	209	OP90	58
AL424A	94	AP200D	210	CBB2Y	149	CT84031	176	EW60WC	6	FC600	57, 212	IP4022B40P	209	OR18	221
AL424GA	94	AP24	18	CBB3BL	149	CT84119	176	EW80	6	FFB10R	171	IP4022B40PTH	209	OR24	221
AL426A	94	AP25	211	CBB4TN	149	CT84122	176	EW80F	7	FFB20L	171	IP4022B64PTH	209	OR36	221
AL426GA	94	AP25D	211	CBB5GR	149	DA3944	144	EW80FWC	7	FFB30D	171	IP4022W20B	209	OR48	221
AL428A	94	AP250	210	CBB6WH	149	DC16242	225	EW80WC	6	FFCH10	213	IP4022W20P	209	OT84010	175
AL428GA	94	AP250D	210	CBD51	173	DC16243	225	EWA1	10	FFCHA10	213	IP4022W40B	209	OT84013	175
AL500A	76	AP2730	144	CBMP1	107	DF13	91	EWA10	10	FFCS10	213	IP4022W40P	209	P1010	39
AL500AE	79	AP30	211	CBMP12	107	DL200A	90	EWA2	10	FFCSA10	213	IP4022W40PTH	209	P1020	39
AL500WPE	79	AP30D	211	CBMP2	107	DL28	91	EWA251	15	FHA10	17, 180	IP4022W64P	209	P1220	39
AL510A	77	AP300	210	CBMP3	107	DL411	91	EWA253	15	FHA11	17, 180	IP4022W64PTH	209	P6015	39
AL510AE	79	AP300D	210	CBMP4	107	DL801A	90	EWA255	15	FHA12	17, 180	IP402520BL	69, 209	P7020	39
AL520A	76	AP32	18	CBMP6	107	DMS6	113	EWA3	10	FHA13	17, 180	IP402520G	69, 209	P8015	39
AL520AE	79	AP350	210	CBMP8	107	DMS8	113	EWA4	10	FHA14	17, 180	IP402520R	69, 209	P8020	39
AL520WPE	79	AP350D	210	CC10	53	DM59	113	EWA5	10	FHA15	17, 180	IP402520Y	69, 209	P9015	39
AL530A	77	AP40	18	CCLT4C5	220	DO10	166	EWA7	10	FHA16	17, 180	IP403520	69, 209	P9020	39
AL530AE	79	AP60	18	CCW1S	144	DO8	166	EWA8	10	FHA17	17, 180	IUD4H	222	PC100012	131
AL540A	78	AP80	18	CCW2M	144	D51725	47	EWAB12	26	FHA8	17, 180	IUD4LB	222	PC100024	131
AL540AE	79	APC10	18	CCW3L	144	DSF11	91	EWAB16	26	FHA9	17, 180	KW49	132	PC10006	131
AL540WPE	79	APC12	18	CCW3XL	144	DSF11P	91	EWAB20	26	FRM13	145	L1218	149	PC100064	131
AL550	52	APC16	18	CD1	210	DSF13	91	EWAB24	26	FRM15	145	L1520	149	PC1011-10	73, 121
AL550A	78	APC20	18	CD2	210	DSF13P	91	EWAB32	26	FRM17	145	L1824	149	PC1011-20	73, 121
AL550AE	79	APC24	18	CF8	166	DT84116	175	EWAB40	26	FS8446	136	L3696	149	PC1011-30	73, 121
AL550WPE	79	APC32	18	CFJ250	222	DT84117	175	EWAB60	26	FT84028	176	LC15B	210	PC1011-40	73, 121
AL552	52	APC40	18	CFS10	211	E12510	127	EWAB80	26	FW10	132	LC150	210	PC1011-50	73, 121
AL560A	78	APC60	18	CFS120	211	E125100	127	EWAH5	11	FW10NSF	131	LCP35	222	PC1011-60	73, 121
AL560AE	79	APC80	18	CFS150	211	E12512	127	EWAH7	11	FW12	132	LO10	221	PC105P10	159
AL570A	78	APS1	21	CFS200	211	E12516	127	EWAH8	11	FW12NSF	131	LSP35	222	PC105P10WHCH	
AL570AE	79	APS10	21	CH13V	144	E12520	127	EWBR10	12	FW14	132	LTC45	220		156
AL61100	64	APS2	21	CH16V	144	E12524	127	EWBR10WC	12	FW14NSF	131	M05	33	PC105P12	159
AL61101	64	APS3	21	CH420	202	E12530	127	EWBR15	12	FW16	132	M1	163	PC105P12WHCH	
AL61102	64	APS4	21	CH485	202	E12540	127	EWBR15WC	12	FW16NSF	131	M10	33		156
AL61505P	192	APS5	21	CK20512	39, 68	E12550	127	EWBR18	12	FW18	132	M10PHP	163	PC105P14	159
AL61515P	192	APS7	21	CKB10	102	E1256	127	EWBR18WC	12	FW18NSF	131	M11	163	PC105P14WHCH	
AL61545P	192	APSC1	21	CP2002	104	E12560	127	EWBR207	12	FW20	132	M12	163		156
AL61555P	192	APSC10	21	CP2002NC	104	E12570	127	EWBR207WC	12	FW20NSF	131	M1218	149	PC105P425WHCH	
AL61565P	192	APSC2	21	CP2122	104	E1258	127	EWBR210	12	FW22	132	M13	163		156
AL61585	192	APSC3	21	CP2122NC	104	EB16	26	EWBR210WC	12	FW22NSF	131	M14	163	PC105P6	159
AL61601W	64	APSC4	21	CP2132	104	EB20	26	EWBR215	12	FW24	132	M1520	149	PC105P6WHCH	156
AL61602W	64	APSC5	21	CP2132NC	104	EB24	26	EWBR215WC	12	FW24NSF	131	M1824	149	PC105P8	159
AL61603W	64	APSC7	21	CP2142	104	EB32	26	EWBR218	12	FW310	132	M2	163	PC105P8WHCH	156
AL62101	64	ASP14	19	CP2142NC	104	EB40	26	EWBR218WC	12	FW312	132	M20	33	PC12010	153
AL62102	64	ASP20	19	CP2162	104	EB60	26	EWBR224	12	FW314	132	M3696	149	PC12012	153
AL62103	64	ASP26	19	CP2162NC	104	EB80	26	EWBR224WC	12	FW316	132	M4	163	PC12014	153
AL62401	64	ASP34	19	CP2224L	102	ELH100	79	EWBR24	12	FW318	132	M40	33	PC12110	160
AL62401W	64	ASP40	19	CP27	167	ELH110	79	EWBR24WC	12	FW320	132	M5	163	PC12116	160
AL62402	64	ASPC14	19	CP290	52	ELH120	81	EWBR7	12	FW322	132	M6	163	PC1216CH	155
AL62402W	64	ASPC20	19	CP5002	104	EW010	7	EWBR7WC	12	FW324	132	M7	163	PC1217	160
AL62403	64	ASPC26	19	CP5002NC	104	EW010WC	7	EW1C	10	GB8700	228	M8	163	PC1217CH	155
AL62403W	64	ASPC34	19	CP5122	104	EW06	7	EW1C10	10, 13	GB8702	228	M9	163	PC1218	160
AL63201	64	ASPC40	19	CP5122NC	104	EW06WC	7	EW1C2	10	GB8704	228	M81	116	PC1218CH	155
AL63201W	64	ASTP3	21	CP5132	104	EW0812	7	EW1C20	10, 13	GB8706	229	M82	116	PC1219	160
AL63202	64	ASTP5	21	CP5132NC	104	EW0812WC	7	EW1C3	10	GB8708	229	M83	116	PC1219CH	155
AL63202W	64	ASTP7	21	CP5142	104	EW10	6	EW1C4	10	GC105B	201	MC10	169	PC12625	153
AL63203	64	B0100	28	CP5142NC	104	EW1018	9	EW1C40	13	GR10	59	MC32	169	PC12625AST	154
AL63203W	64	B0120	28	CP5162	104	EW1020	9	EW1C60	13	GR10C	59	MC388	57	PC12625CH	155
AL720A	95	B0140	28	CP5162NC	104	EW1025	9	EW1C7	10	GR16	59	MHSS10	160	PC12625WHCH	156
AL800A	95	B090	28	CP5192	104	EW1030	9	EW1C8	10	GR16C	59	MHSS12	160	PC1276C	153
AL800HDCA	95	B147	37, 131	CP5192NC	104	EW1035	9	EW1C80	13	GR24	59	MHSS14	160	PC1276CCCH	155
AL801A	95	B172	37, 131	CP5232	104	EW10WC	6	EWDB10	13	GR24C	59	MHSS16	160	PC1276WHCH	156
AL820A	95	B175	37, 131	CP5232NC	104	EW12	6	EWDB12	13	GR30	54	MHSS18	160	PC1280	159
AL84	96	B2134P	47	CP527	167	EW12WC	6	EWDB20	13	GR30S	54	MHSS20	160	PC1280GR	152
AL900	81	B2164P	47	CP7002	104	EW14	7	EWDB10	13	HA10	17, 180	MHSS22	160	PC1280WHCH	157
AL910	81	B35	58	CP7002NC	104	EW14WC	7	EWDB12	13	HA11	17, 180	MHSS6	160	PC1286	153
AL9115W	42	B4106	46	CP7122	104	EW16	6	EWDB120	13	HA12	17, 180	MHSS8	160	PC1286CH	155
AL9116W	42	B4107	46	CP7122NC											

ITEM	PAGE	ITEM	PAGE	ITEM	PAGE	ITEM	PAGE	ITEM	PAGE	ITEM	PAGE	ITEM	PAGE	ITEM	PAGE
PC12910CH	155	PC3509-50	73	PECR24W	71	PER1218MP	150, 177	PT8B	72	S771	115	SK15	161	SSSPL80100	23
PC12910GR	152	PC3509-60	73	PECR68G	71	PER1218MR	150	PT8C	72	S772	115	SK16	161	SSSTP3	24
PC12910GRCH	154	PC3512-10	73	PECR68R	71	PER1218MTN	150	PT8R	72	S773	115	SK17	161	SSSTP5	24
PC12910PLCH	154, 177	PC3512-20	73	PECR68W	71	PER1218MY	150	PT9A	72	S774	115	SK3	166	SSSTP7	24
PC12910RD	152	PC3512-30	73	PECS1016G	71	PER1218R	148	PT9B	72	S775	115	SK5	166	SU382	96
PC12910RDCH	152	PC3512-40	73	PECS1016R	71	PER1218T	148	PT9C	72	S776	115	SK6	166	SU482	96
PC12910TCH	154	PC3512-50	73	PECS1016W	71	PER1218Y	148	PT9R	72	S777	115	SK8	166	SYR2	196
PC12910TN	152	PC3512-60	73	PECS13G	71	PER1520	149	PT84101	174	S778	115	SM6M	218	TB8M	142
PC12910TNCH	154	PC3760-10	73	PECS13R	71	PER1520AST	148	PT84104	174	S779	115	SM6MR	218	TC1	139
PC12910WH	152	PC3760-20	73	PECS13W	71	PER1520B	148	PT84107	174	S780	115	SM6MW	218	TC45	219
PC12910WHCH	154	PC3760-30	73	PECS57G	71	PER1520G	148	PT84110	174	S781	115	SM6R	218	TC65	219
PC12910YL	152	PC3760-40	73	PECS57R	71	PER1520MBL	150	PT84113	174	S8095	111	SM6W	218	TC896	199
PC12910YLCH	154	PC3760-50	73	PECS57W	71	PER1520MD	150	PW10	132	S8098	111	SO128PU	218	TC85	219
PC12912	153	PC3760-60	73	PEL1218	149	PER1520MG	150	PW10NSF	131	S8099	111	SOM13	145	TCDA	219
PC12912BL	152	PC3762-10	73	PEL1218B	148	PER1520MP	150, 177	PW12	132	S8195	111	SOM15	145	TCDE	219
PC12912BLCH	154	PC3762-20	73	PEL1218G	148	PER1520MR	150	PW12NSF	131	S8198	111	SOM17	145	TCDE	219
PC12912CH	155	PC3762-30	73	PEL1218MBL	150	PER1520MTN	150	PW14	132	S8199	111	SP8006	106	TH1	217
PC12912GR	152	PC3762-40	73	PEL1218MD	150	PER1520MY	150	PW41ANSF	131	S825	212	SPH322BLK	196	TH23	217
PC12912GRCH	154	PC3762-50	73	PEL1218MG	150	PER1520R	148	PW16	132	S871	115	SPH322BR	196	TH34	217
PC12912RD	152	PC3762-60	73	PEL1218MR	150	PER1520T	148	PW16NSF	131	S872	115	SPH322CLR	196	TH45	217
PC12912RDCH	154	PC54WHCH	157	PEL1218MTN	150	PER1520Y	148	PW18	132	S873	115	SPH322WH	196	TSBLL	142
PC12912TN	152	PC56WHCH	157	PEL1218MY	150	PER1824	149	PW18NSF	131	S874	115	SPS10	181	TW82BLK	218
PC12912TNCH	154	PC6639-10	73	PEL1218R	148	PER1824AST	148	PW310	132	S875	115	SPS11	181	TW82BRN	218
PC12912WH	152	PC6639-20	73	PEL1218T	148	PER1824B	148	PW312	132	S876	115	SPS12	181	U12110	128
PC12912WHCH	154	PC6639-30	73	PEL1218Y	148	PER1824G	148	PW314	132	S877	115	SPS13	181	U121100	128
PC12912YL	152	PC6639-40	73	PEL1520	149	PER1824MBL	150	PW316	132	S878	115	SPS14	181	U12112	128
PC12912YLCH	154	PC6639-50	73	PEL1520B	148	PER1824MD	150	PW318	132	S879	115	SPS15	181	U12116	128
PC1298	153	PC6639-60	73	PEL1520G	148	PER1824MG	150	PW8NSF	131	S880	115	SPS16	181	U12120	128
PC1298CH	155	PC8841-10	73, 121	PEL1520MBL	150	PER1824MP	150, 177	R128	149	S881	115	SPS17	181	U12124	128
PC1517WHCH	157	PC8841-20	73, 121	PEL1520MD	150	PER1824MR	150	R1520	149	S9093	111	SPS18	181	U12130	128
PC1527WHCH	156	PC8841-30	73, 121	PEL1520MG	150	PER1824MTN	150	R1824	149	S9095	111	SPS7	181	U12140	128
PC15310	153	PC8841-40	73, 121	PEL1520MR	150	PER1520R	150	R23	114	S9098	111	SPS8	181	U12150	128
PC15312	153	PC8841-50	73, 121	PEL1520MTN	150	PER1824R	148	R27	114	S9099	111	SPS9	181	U12160	128
PC15410	153	PC8841-60	73, 121	PEL1520MY	150	PER1824T	148	R33	114	S9100	111	SQ1280	158	U12170	128
PC15410CH	155	PC996	181	PEL1520R	148	PER1824Y	148	R3696	149	S9150	111	SQ675	113	U1218	128
PC15412	153	PCC22002	70	PEL1520T	148	PER1830	149	R39	114	S9193	111	SR117PU	218	U12210	128
PC15412CH	155	PCC22002NC	70	PEL1520Y	148	PER4896	149	R39D	114	S9195	111	SR22	59	U122100	128
PC15412WHCH	156	PCC22122	70	PEL1824	149	PER69	149	RC100	97, 106	S9198	111	SR22D	59	U12212	128
PC15414	155	PCC22122NC	70	PEL1824B	148	PF610R	171	RD1004A	80	S9199	111	SR32	59	U12216	128
PC15414CH	153	PCC22132	70	PEL1824G	148	PF820L	171	RD1006A	80	S9200	111	SR32D	59	U12220	128
PC15510	153	PCC22132NC	70	PEL1824MBL	150	PF830D	171	RD1011A	80	S9250	111	SR42	59	U12224	128
PC15510CH	155	PCC22142	70	PEL1824MD	150	PG1	182	RD130A	90	S950	212	SR42D	59	U12230	128
PC15512	153	PCC22142NC	70	PEL1824MG	150	PG1018	106	RD400RTA	84	S980	212	SR51	59	U12240	128
PC15512CH	155	PCC22162	70	PEL1824MR	150	PG1826	106	RD582	42, 183	S9908	35	SG100	211	U12250	128
PC1558WHCH	156	PCC22162NC	70	PEL1824MTN	150	PG510	106	RD650	113	S9910	35	SS100010	36, 130	U12260	128
PC1559WHCH	156	PCC22192	70	PEL1824MY	150	PG810	106	RFM3BL	193	S9912	35	SS100012	36, 130	U12270	128
PC15610	153	PCC22192NC	70	PEL1824R	148	PH58	145	RFM3BLK	193	S9914	35	SS100014	36, 130	U1228	128
PC15612	153	PCCR1	71	PEL1824T	148	POM13	145	RFM3BO	193	S9916	35	SS100015	36, 130	UP1	164
PC182WHCH	157	PCD100	70	PEL1824Y	148	POM15	145	RFM3RD	193	SA11	17, 180	SS10008	36, 130	U01012	107
PC2001	181	PCD16	70	PEL1830	149	POM17	145	RFM3WH	193	SA13	17, 180	SS70	211	V105	107
PC2013	159	PCD25	70	PEL4896	149	POM24	145	RFM3YL	193	SA15	17, 180	SS8	110	V10612	107
PC2013WHCH	157	PCD33	70	PEL69	149	PP1	183	RG9	167	SA17	17, 180	SSBR15	23	V10812	107
PC219P	159	PCD50	70	PEM1218	149	PP1BR	53	RNST11BLK	68	SBD520	173	SSBR20	23	VIC01012	107
PC219PRD	152	PCML6G	194	PEM1218B	148	PP21	43	RNST11BR	68	SC750	221	SSBR25	23	VIC05	107
PC219PWHCH	157	PCML05	72	PEM1218G	148	PP2GR	53	RNST1216BLK	68	SCREW12	124	SSBR30	23	VIC0612	107
PC22002	70	PCML10	72	PEM1218MBL	150	PP3RD	53	RNST1216BR	68	SD2571	34, 185	SSF100	211	VIC0812	107
PC22004	70	PCML20	72	PEM1218MD	150	PP4OR	53	RNST14BLK	68	SD3571	34, 185	SSF70	211	WR4004	195
PC22006	70	PCML30	72	PEM1218MG	150	PP5WH	53	RNST14BR	68	SD4571	34, 185	SSFP11	24	WR5002	195
PC22008	70	PCML50	72	PEM1218MR	150	PP6YL	53	RNST1418BLK	68	SD4871	34	SSFP12	24	WR6001	195
PC22122	70	PCOS10SP10WHCH		PEM1218MTN	150	PO1BR	53	RNST1418BR	68	SDH2571	34, 185	SSFP14	24	WR6002	195
PC22124	70		156	PEM1218MY	150	PQ2GR	53	RNST1520BLK	68	SDH3571	34, 185	SSFP8	24	WR7002	195
PC22126	70	PCOS10SP12WHCH		PEM1218R	148	PQ3RD	53	RNST1520BR	68	SDU12220	41, 128	SSFP9	24	WR7003	195
PC22128	70		156	PEM1218T	148	PQ4OR	53	RNST16BLK	68	SDU12230	41, 128	SSFP11	24	WRG1525	47
PC22132	70	PCOS10SP14WHCH		PEM1218Y	148	PQ5WH	53	RNST16BR	68	SEG18	10	SSFP12	24	WRG1612	16
PC22134	70		156	PEM1520	149	PQ6YL	53	RP25W	220	SEG25	10	SSFP14	24	WRG1624	16
PC22136	70	PCOS10SP425WHCH		PEM1520B	148	PS10	181	RS8053P	194	SEG35	10	SSFP8	24	WSD100	223
PC22138	70		156	PEM1520G	148	PS11	181	RSJ350	222	SEW1018	8	SSFP9	24	WSD100C	223
PC22142	70	PCOS10SP6WHCH		PEM1520MBL	150	PS12	181	RT84016	175	SEW1020	8	SG4	137	XB1	162
PC22144	70		156	PEM1520MD	150	PS13	181	RT84019	175	SEW1025	8	SG449	137	XB2	162
PC22146	70	PCOS10SP8WHCH		PEM1520MG	150	PS14	181	S0100	28	SEW1030	8	SSP1	213	XB5	162
PC22162	70		156	PEM1520MR	150	PS15	181	S0120	28	SEW1035	8	SSP2	213		
PC22164	70	PCP321	69	PEM1520MTN	150	PS16	181	S0140	28	SEW5018	9	SSP3	213		
PC22166	70	PCP601	69	PEM1520MY	150	PS17	181	S090	28	SEW5020	9	SSPH1	213		
PC22192	70	PCP603	69	PEM1520R	148	PS18	181	S202	214	SEW5025	9	SSPH2	213		
PC22194	70	PCP603A	69	PEM1520T	148	PS180	182	S3202	214	SEW5030	9	SSPH3	213		
PC233HT	159	PCPT600	69	PEM1520Y	148	PS8	181	S500	220	SEW5035	9	SSSP10	23		
PC233HTRD	152	PCSC1R	71	PEM1824	149	PS9	181	S5010C	112	SEWA1	11	SSSP100	22		
PC24WHCH	157	PCSC1S	71	PEM1824B	148	PT12A	72	S5010F	112	SEWA2	11	SSSP12	22		
PC255	159	PCSC1OR	71	PEM1824G	148	PT12B	72	S5012C	112	SEWA3	11	SSSP16	22		
PC25WHCH	157	PCSC1OS	71	PEM1824MBL	150	PT12C	72	S5012F	112	SEWA4	11	SSSP2	23		
PC2885	159	PCSC15R	71	PEM1824MD	150	PT12R	72	S507C	112	SEWA5	11	SSSP20	22		
PC288WHCH	157	PCSC16S	71	PEM1824MG	150	PT16A	72	S507F	112	SEWA7	11	SSSP24	22		
PC3506-10	73	PCSC19R	71	PEM1824MR	150	PT16B	72	S508C	112	SEWA8	11	SSSP3	23		
PC3506-20	73	PCSC2R	71	PEM1824MTN	150	PT16C									



Алматы (727)345-47-04
 Ангарск (3955)60-70-56
 Архангельск (8182)63-90-72
 Астрахань (8512)99-46-04
 Барнаул (3852)73-04-60
 Белгород (4722)40-23-64
 Благовещенск (4162)22-76-07
 Брянск (4832)59-03-52
 Владивосток (423)249-28-31
 Владикавказ (8672)28-90-48
 Владимир (4922)49-43-18
 Волгоград (844)278-03-48
 Вологда (8172)26-41-59
 Воронеж (473)204-51-73
 Екатеринбург (343)384-55-89

Россия +7(495)268-04-70

Иваново (4932)77-34-06
 Ижевск (3412)26-03-58
 Иркутск (395)279-98-46
 Казань (843)206-01-48
 Калининград (4012)72-03-81
 Калуга (4842)92-23-67
 Кемерово (3842)65-04-62
 Киров (8332)68-02-04
 Коломна (4966)23-41-49
 Кострома (4942)77-07-48
 Краснодар (861)203-40-90
 Красноярск (391)204-63-61
 Курск (4712)77-13-04
 Курган (3522)50-90-47
 Липецк (4742)52-20-81

Казахстан +7(727)345-47-04

Магнитогорск (3519)55-03-13
 Москва (495)268-04-70
 Мурманск (8152)59-64-93
 Набережные Челны (8552)20-53-41
 Нижний Новгород (831)429-08-12
 Новокузнецк (3843)20-46-81
 Ноябрьск (3496)41-32-12
 Новосибирск (383)227-86-73
 Омск (3812)21-46-40
 Орел (4862)44-53-42
 Оренбург (3532)37-68-04
 Пенза (8412)22-31-16
 Петрозаводск (8142)55-98-37
 Псков (8112)59-10-37
 Пермь (342)205-81-47

Беларусь +(375)257-127-884

Ростов-на-Дону (863)308-18-15
 Рязань (4912)46-61-64
 Самара (846)206-03-16
 Санкт-Петербург (812)309-46-40
 Саранск (8342)22-96-24
 Саратов (845)249-38-78
 Севастополь (8692)22-31-93
 Симферополь (3652)67-13-56
 Смоленск (4812)29-41-54
 Сочи (862)225-72-31
 Ставрополь (8652)20-65-13
 Сургут (3462)77-98-35
 Сыктывкар (8212)25-95-17
 Тамбов (4752)50-40-97
 Тверь (4822)63-31-35

Узбекистан +998(71)205-18-59

Тольятти (8482)63-91-07
 Томск (3822)98-41-53
 Тула (4872)33-79-87
 Тюмень (3452)66-21-18
 Улан-Удэ (3012)59-97-51
 Ульяновск (8422)24-23-59
 Уфа (347)229-48-12
 Хабаровск (4212)92-98-04
 Чебоксары (8352)28-53-07
 Челябинск (351)202-03-61
 Череповец (8202)49-02-64
 Чита (3022)38-34-83
 Якутск (4112)23-90-97
 Ярославль (4852)69-52-93

Киргизия +996(312)96-26-47